

# Service Manual

## Air Conditioner

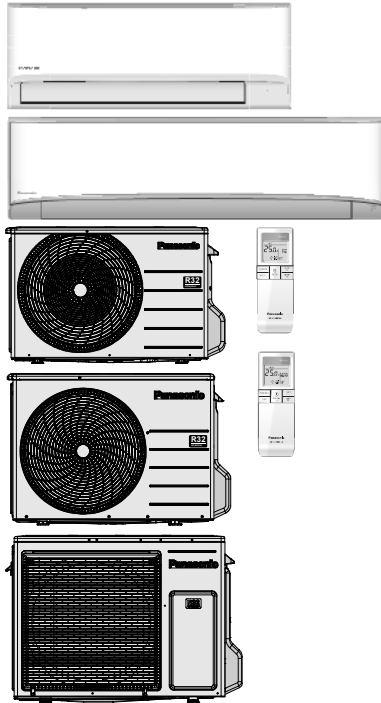

Indoor Unit	Outdoor Unit
CS-TZ20WKEW	CU-TZ20WKE
CS-TZ25WKEW	CU-TZ25WKE
CS-TZ35WKEW	CU-TZ35WKE
CS-TZ42WKEW	CU-TZ42WKE
CS-TZ50WKEW	CU-TZ50WKE
CS-TZ60WKEW	CU-TZ60WKE
CS-TZ71WKEW	CU-TZ71WKE
CS-RZ20WKEW	CU-RZ20WKE
CS-RZ25WKEW	CU-RZ25WKE
CS-RZ35WKEW	CU-RZ35WKE
CS-RZ50WKEW	CU-RZ50WKE

Destination  
Europe  
Turkey

Please file and use this manual together with the service manual for Model No. CU-2Z35TBE, CU-2Z41TBE, CU-2Z50TBE, CU-3Z52TBE, CU-3Z68TBE, CU-4Z68TBE, CU-4Z80TBE, CU-5Z90TBE, CU-2TZ41TBE, CU-2TZ50TBE, CU-3TZ52TBE, Order No. PAPAMY1702035CE, PAPAMY1703049CE, PAPAMY1710082CE, PAPAMY1802045CE, PAPAMY1802091CE.

### ⚠ WARNING

This service information is designed for experienced repair technicians only and is not designed for use by the general public. It does not contain warnings or cautions to advise non-technical individuals of potential dangers in attempting to service a product. Products powered by electricity should be serviced or repaired only by experienced professional technicians. Any attempt to service or repair the products dealt with in this service information by anyone else could result in serious injury or death.

### IMPORTANT SAFETY NOTICE

There are special components used in this equipment which are important for safety. These parts are marked by ⚠ in the Schematic Diagrams, Circuit Board Diagrams, Exploded Views and Replacement Parts List. It is essential that these critical parts should be replaced with manufacturer's specified parts to prevent shock, fire or other hazards. Do not modify the original design without permission of manufacturer.

### ⚠ PRECAUTION OF LOW TEMPERATURE

In order to avoid frostbite, be assured of no refrigerant leakage during the installation or repairing of refrigerant circuit.

### ⚠ CAUTION

**R32 REFRIGERANT** – This Air Conditioner contains and operates with refrigerant R32.  
**THIS PRODUCT MUST ONLY BE INSTALLED OR SERVICED BY QUALIFIED PERSONNEL.**  
Refer to National, State, Territory and local legislation, regulations, codes, installation & operation manuals, before the installation, maintenance and/or service of this product.

## ⚠ CAUTION

Before performing any of the electrical installation works, please verify on which of the intended connection use. Generally there are 2 types of indoor-outdoor connections:

- Ⓐ Single Connection (Single Indoor Unit connects with Single Outdoor Unit)
- Ⓑ Multiple Connection (Multiple Indoor Unit connect with Single Outdoor Unit)

Both connections have different connecting methods. Any mismatch connections will result in malfunctions. The following illustration demonstrates the correct electrical works for both type.

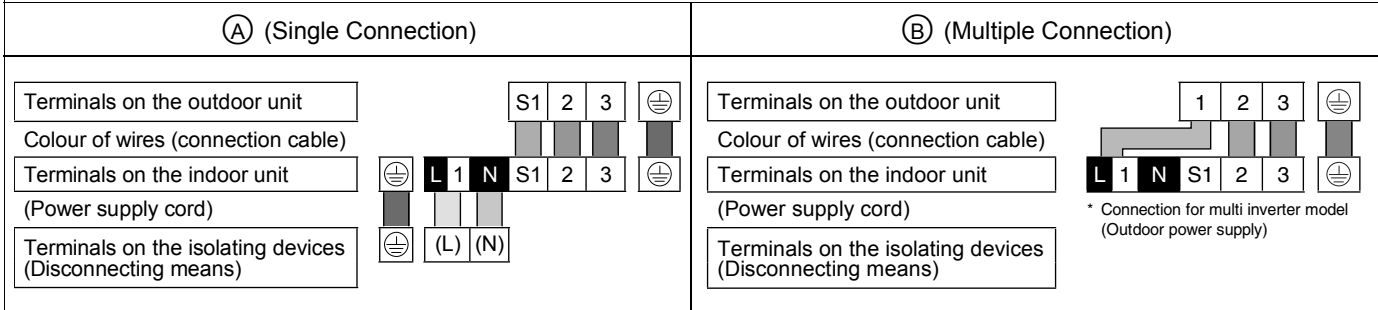

Please refer to the provided Installation Instructions for the detailed procedures for connecting cables to Indoor Unit.



# TABLE OF CONTENTS

	PAGE		PAGE
<b>1. Safety Precautions</b> .....	<b>5</b>	<b>14. Operation Control</b> .....	<b>95</b>
<b>2. Precaution for Using R32 Refrigerant</b> .....	<b>8</b>	14.1 Basic Function .....	95
<b>3. Specifications</b> .....	<b>12</b>	14.2 Indoor Fan Motor Operation .....	96
<b>4. Features</b> .....	<b>33</b>	14.3 Outdoor Fan Motor Operation .....	97
<b>5. Location of Controls and Components</b> .....	<b>34</b>	14.4 Airflow Direction .....	98
5.1 Indoor Unit.....	34	14.5 Timer Control.....	101
5.2 Outdoor Unit.....	34	14.6 Sleep Mode Operation .....	102
5.3 Remote Control .....	35	14.7 Auto Restart Control.....	103
<b>6. Dimensions</b> .....	<b>36</b>	14.8 Indication Panel.....	103
6.1 Indoor Unit.....	36	14.9 Quiet Operation (Cooling Mode/Cooling Area of Dry Mode) .....	103
6.2 Outdoor Unit.....	38	14.10 Quiet Operation (Heating) .....	104
<b>7. Refrigeration Cycle Diagram</b> .....	<b>40</b>	14.11 Powerful Mode Operation .....	104
7.1 CS-TZ20WKEW CU-TZ20WKE		14.12 Wireless LAN Control .....	104
CS-TZ25WKEW CU-TZ25WKE		<b>15. Operation Control</b>	
CS-TZ35WKEW CU-TZ35WKE		<b>(For Multi Split Connection)</b> .....	<b>107</b>
CS-TZ42WKEW CU-TZ42WKE		15.1 Cooling operation .....	107
CS-RZ20WKEW CU-RZ20WKE		15.2 Soft Dry Operation.....	107
CS-RZ25WKEW CU-RZ25WKE		15.3 Heating Operation .....	107
CS-RZ35WKEW CU-RZ35WKE .....	40	15.4 Automatic Operation .....	108
7.2 CS-TZ50WKEW CU-TZ50WKE		15.5 Indoor Fan Motor Operation .....	108
CS-TZ60WKEW CU-TZ60WKE		15.6 Powerful Mode Operation .....	108
CS-RZ50WKEW CU-RZ50WKE .....	41	15.7 Auto Restart Control.....	108
7.3 CS-TZ71WKEW CU-TZ71WKE .....	42	15.8 Indication Panel.....	108
<b>8. Block Diagram</b> .....	<b>43</b>	<b>16. Protection Control</b> .....	<b>109</b>
8.1 Indoor Unit.....	43	16.1 Protection Control for All Operations.....	109
8.2 Outdoor Unit.....	44	16.2 Protection Control for Cooling & Soft Dry Operation.....	111
<b>9. Wiring Connection Diagram</b> .....	<b>46</b>	16.3 Protection Control for Heating Operation.....	112
9.1 Indoor Unit.....	46	<b>17. Servicing Mode</b> .....	<b>114</b>
9.2 Outdoor Unit.....	48	17.1 Auto OFF/ON Button .....	114
<b>10. Electronic Circuit Diagram</b> .....	<b>50</b>	17.2 Heat Only Operation .....	115
10.1 Indoor Unit.....	50	17.3 Remote Control Button.....	117
10.2 Outdoor Unit.....	52	<b>18. Troubleshooting Guide</b> .....	<b>124</b>
<b>11. Printed Circuit Board</b> .....	<b>54</b>	18.1 Refrigeration Cycle System.....	124
11.1 Indoor Unit.....	54	18.2 Breakdown Self Diagnosis Function .....	126
11.2 Outdoor Unit.....	58	18.3 Error Codes Table .....	127
<b>12. Installation Instruction</b> .....	<b>61</b>	18.4 Self-diagnosis Method.....	129
12.1 Select the Best Location .....	61	<b>19. Disassembly and Assembly Instructions</b> ....	<b>157</b>
12.2 Indoor Unit.....	63	19.1 CS-TZ20WKEW CS-TZ25WKEW	
12.3 Outdoor Unit.....	71	CS-TZ35WKEW CS-TZ42WKEW	
<b>13. Installation and Servicing Air Conditioner</b> <b>using R32</b> .....	<b>75</b>	CS-TZ50WKEW CS-RZ20WKEW	
13.1 About R32 Refrigerant .....	75	CS-RZ25WKEW CS-RZ35WKEW	
13.2 Characteristics of R32 Refrigerant.....	75	CS-RZ50WKEW .....	157
13.3 Refrigerant piping installation • Tools used in services .....	77	19.2 CS-TZ60WKEW CS-TZ71WKEW.....	162
13.4 New installation, Relocation, Repairing of Refrigerant Cycle System The Procedures.....	81	19.3 To Replace Wireless LAN Module (Network Adapter) .....	167
13.5 Piping installation of R32.....	82	19.4 Outdoor Electronic Controller Removal Procedure .....	168
13.6 Installation, Relocation, and Service.....	83	19.5 To Set Panasonic Comfort Cloud App. After Replace Main Printed Circuit Board and Wireless LAN Module .....	171
13.7 Repairing of refrigerant cycle / Brazing point .....	87		
13.8 <Reference> Analysis method for no error code, no cooling / no warming .....	93		



<b>20. Technical Data .....</b>	<b>181</b>
20.1 Cool Mode Performance Data - Sensible Capacity.....	181
20.2 Heat Mode Performance Data.....	184
<b>21. Service Data .....</b>	<b>186</b>
21.1 Cool Mode Outdoor Air Temperature Characteristic.....	186
21.2 Heat Mode Outdoor Air Temperature Characteristic.....	196
21.3 Piping Length Correction Factor.....	206
<b>22. Exploded View and Replacement Parts List .....</b>	<b>209</b>
22.1 Indoor Unit.....	209
22.2 Outdoor Unit .....	221

# 1. Safety Precautions





- Read the following “SAFETY PRECAUTIONS” carefully before perform any servicing.
- Confirm the type of gas used before installation.
- Electrical work must be installed or serviced by a licensed electrician. Be sure to use the correct rating of the power plug and main circuit for the model to be installed.
- The caution items stated here must be followed because these important contents are related to safety. The meaning of each indication used is as below. Incorrect installation or servicing due to ignoring of the instruction will cause harm or damage, and the seriousness is classified by the following indications.

 <b>WARNING</b>	This indication shows the possibility of causing death or serious injury.
 <b>CAUTION</b>	This indication shows the possibility of causing injury or damage to properties only.











- The items to be followed are classified by the symbols:

	Symbol with white background denotes item that is PROHIBITED.
	Symbol with dark background denotes item that must be carried out.

- Explanation of symbols displayed on the indoor unit or outdoor unit.

 <b>WARNING</b>	This symbol shows that this equipment uses a flammable refrigerant. If the refrigerant is leaked, together with an external ignition source, there is a possibility of ignition.
 <b>CAUTION</b>	This symbol shows type of flammable refrigerant contained in the system.
 <b>CAUTION</b>	This symbol shows that the Installation Manual should be read carefully.
 <b>CAUTION</b>	This symbol shows that a service personnel should be handling this equipment with reference to the Installation Manual.
 <b>CAUTION</b>	This symbol shows that there is information included in the Operation Manual and/or Installation Manual.





- Carry out test run to confirm that no abnormality occurs after the servicing. Then, explain to user the operation, care and maintenance as stated in instructions. Please remind the customer to keep the operating instructions for future reference.

 <b>WARNING</b>		
1.	Do not use means to accelerate the defrosting process or to clean, other than those recommended by the manufacturer. Any unfit method or using incompatible material may cause product damage, burst and serious injury.	
2.	Do not install outdoor unit near handrail of veranda. When installing air-conditioner unit on veranda of a high rise building, child may climb up to outdoor unit and cross over the handrail causing an accident.	
3.	Do not use unspecified cord, modified cord, joint cord or extension cord for power supply cord. Do not share the single outlet with other electrical appliances. Poor contact, poor insulation or over current will cause electrical shock or fire.	
4.	Do not tie up the power supply cord into a bundle by band. Abnormal temperature rise on power supply cord may happen.	
5.	Do not insert your fingers or other objects into the unit, high speed rotating fan may cause injury.	
6.	Do not sit or step on the unit, you may fall down accidentally.	
7.	Keep plastic bag (packaging material) away from small children, it may cling to nose and mouth and prevent breathing.	
8.	When installing or relocating air conditioner, do not let any substance other than the specified refrigerant, eg. air etc mix into refrigeration cycle (piping). Mixing of air etc. will cause abnormal high pressure in refrigeration cycle and result in explosion, injury etc.	
9.	Do not pierce or burn as the appliance is pressurized. Do not expose the appliance to heat, flame, sparks, or other sources of ignition. Else, it may explode and cause injury or death.	
10.	Do not add or replace refrigerant other than specified type. It may cause product damage, burst and injury etc.	

 **WARNING**

11.	<ul style="list-style-type: none"> <li>• For R32/R410A model, use piping, flare nut and tools which is specified for R32/R410A refrigerant. Using of existing (R22) piping, flare nut and tools may cause abnormally high pressure in the refrigerant cycle (piping), and possibly result in explosion and injury. For R32 and R410A, the same flare nut on the outdoor unit side and pipe can be used.</li> <li>• Since the working pressure for R32/R410A is higher than that of refrigerant R22 model, replacing conventional piping and flare nuts on the outdoor unit side are recommended.</li> <li>• If reuse piping in unavoidable, refer to instruction "IN CASE OF REUSING EXISTING REFRIGERANT PIPING".</li> <li>• Thickness of copper pipes used with R32/R410A must be more than 0.8 mm. Never use copper pipes thinner than 0.8 mm.</li> <li>• It is desirable that the amount of residual oil less than 40 mg/10 m.</li> </ul>
12.	Engage authorized dealer or specialist for installation and servicing. If installation or servicing done by the user is incorrect, it will cause water leakage, electrical shock or fire.
13.	For refrigeration system work, Install according to this installation instructions strictly. If installation is defective, it will cause water leakage, electrical shock or fire.
14.	Use the attached accessories parts and specified parts for installation and servicing. Otherwise, it will cause the set to fall, water leakage, fire or electrical shock.
15.	Install at a strong and firm location which is able to withstand weight of the set. If the strength is not enough or installation is not properly done, the set will drop and cause injury.
16.	For electrical work, follow the national regulation, legislation and this installation instructions. An independent circuit and single outlet must be used. If electrical circuit capacity is not enough or defect found in the electrical work, it will cause electrical shock or fire.
17.	Do not use joint cable for indoor/outdoor connection cable. Use the specified indoor/outdoor connection cable, refer to instruction <b>CONNECT THE CABLE TO THE INDOOR UNIT</b> and connect tightly for indoor/outdoor connection. Clamp the cable so that no external force will have impact on the terminal. If connection or fixing is not perfect, it will cause heat up or fire at the connection.
18.	Wire routing must be properly arranged so that control board cover is fixed properly. If control board cover is not fixed perfectly, it will cause fire or electrical shock.
19.	This equipment is strongly recommended to be installed with Earth Leakage Circuit Breaker (ELCB) or Residual Current Device (RCD), with sensitivity of 30mA at 0.1 sec or less. Otherwise, it may cause electrical shock and fire in case of equipment breakdown or insulation breakdown.
20.	During installation, install the refrigerant piping properly before running the compressor. Operation of compressor without fixing refrigeration piping and valves at opened position will cause suck-in of air, abnormal high pressure in refrigeration cycle and result in explosion, injury etc.
21.	During pump down operation, stop the compressor before removing the refrigeration piping. Removal of refrigeration piping while compressor is operating and valves are opened will cause suck-in of air, abnormal high pressure in refrigeration cycle and result in explosion, injury etc.
22.	Tighten the flare nut with torque wrench according to specified method. If the flare nut is over-tightened, after a long period, the flare may break and cause refrigerant gas leakage.
23.	After completion of installation or service, confirm there is no leakage of refrigerant gas. It may generate toxic gas when the refrigerant contacts with fire.
24.	Ventilate if there is refrigerant gas leakage during operation. It may cause toxic gas when the refrigerant contacts with fire.
25.	Be aware that refrigerants may not contain an odour.
26.	This equipment must be properly earthed. Earth line must not be connected to gas pipe, water pipe, earth of lightning rod and telephone. Otherwise, it may cause electrical shock in case of equipment breakdown or insulation breakdown.
27.	Do not modify the machine, part, material during repairing service.
28.	If wiring unit is supplied as repairing part, do not repair or connect the wire even only partial wire break. Exchange the whole wiring unit.
29.	Do not wrench the fasten terminal. Pull it out or insert it straightly.
30.	Must not use other parts except original parts describe in catalog and manual.

 **CAUTION**

1.	Do not install the unit in a place where leakage of flammable gas may occur. In case gas leaks and accumulates at surrounding of the unit, it may cause fire.	
2.	Prevent liquid or vapor from entering sumps or sewers since vapor is heavier than air and may form suffocating atmospheres.	
3.	Do not release refrigerant during piping work for installation, servicing, reinstallation and during repairing a refrigerant parts. Take care of the liquid refrigerant, it may cause frostbite.	
4.	Do not install this appliance in a laundry room or other location where water may drip from the ceiling, etc.	
5.	Do not touch the sharp aluminium fin, sharp parts may cause injury.	
6.	Carry out drainage piping as mentioned in installation instructions. If drainage is not perfect, water may enter the room and damage the furniture.	

 **CAUTION**

7.	Select an installation location which is easy for maintenance. Incorrect installation, service or repair of this air conditioner may increase the risk of rupture and this may result in loss damage or injury and/or property.
8.	Power supply connection to the room air conditioner. Use power supply cord 3 x 1.5 mm <sup>2</sup> (3/4 ~ 1.75HP), 3 x 2.5 mm <sup>2</sup> (2.0 ~ 2.5HP) type designation 60245 IEC 57 or heavier cord. Connect the power supply cord of the air conditioner to the mains using one of the following method. Power supply point should be in easily accessible place for power disconnection in case of emergency. In some countries, permanent connection of this air conditioner to the power supply is prohibited. 1) Power supply connection to the receptacle using power plug. Use an approved 15/16A (3/4 ~ 1.75HP), 16A (2.0 ~ 2.25HP), 20A (2.5HP) power plug with earth pin for the connection to the socket. 2) Power supply connection to a circuit breaker for the permanent connection. Use an approved 16A (3/4 ~ 2.25HP), 20A (2.5HP) circuit breaker for the permanent connection. It must be a double pole switch with a minimum 3.0 mm contact gap.
9.	Installation or servicing work: It may need two people to carry out the installation or servicing work.
10.	Keep any required ventilation openings clear of obstruction.
11.	Pb free solder has a higher melting point than standard solder; typically the melting point is 50°F – 70°F (30°C – 40°C) higher. Please use a high temperature solder iron. In case of the soldering iron with temperature control, please set it to 700 ± 20°F (370 ± 10°C). Pb free solder will tend to splash when heated too high (about 1100°F / 600°C).
12.	Do not touch the sharp aluminum fins or edges of metal parts. If you are required to handle sharp parts during installation or servicing, please wear hand glove. Sharp parts may cause injury.
13.	Tighten the flare nut with torque wrench according to specified method. If the flare nut is over-tightened, after a long period, the flare may break and cause refrigerant gas leakage.
14.	Do not touch outdoor unit air inlet and aluminium fin. It may cause injury.



## 2. Precaution for Using R32 Refrigerant

- Pay careful attention to the following precaution points and the installation work procedures:

 <b>WARNING</b>	
1.	When connecting flare at indoor side, make sure that the flare connection is used only once, if torqued up and released, the flare must be remade. Once the flare connection was torqued up correctly and leak test was made, thoroughly clean and dry the surface to remove oil, dirt and grease by following instructions of silicone sealant. Apply neutral cure (Alkoxy type) & ammonia-free silicone sealant that is non-corrosive to copper & brass to the external of the flared connection to prevent the ingress of moisture on both the gas & liquid sides. (Moisture may cause freezing and premature failure of the connection)
2.	The appliance shall be stored, installed and operated in a well ventilated room with indoor floor area larger than $A_{min}$ (m <sup>2</sup> ) [refer Table A] and without any continuously operating ignition source. Keep away from open flames, any operating gas appliances or any operating electric heater. Else, it may explode and cause injury or death.
3.	The mixing of different refrigerants within a system is prohibited. Models that use refrigerant R32 and R410A have a different charging port thread diameter to prevent erroneous charging with refrigerant R22 and for safety. Therefore, check beforehand. [The charging port thread diameter for R32 and R410A is 12.7 mm (1/2 inch).]
4.	Ensure that foreign matter (oil, water, etc.) does not enter the piping. Also, when storing the piping, securely seal the opening by pinching, taping, etc. (Handling of R32 is similar to R410A.)
5.	Operation, maintenance, repairing and refrigerant recovery should be carried out by trained and certified personnel in the use of flammable refrigerants and as recommended by the manufacturer. Any personnel conducting an operation, servicing or maintenance on a system or associated parts of the equipment should be trained and certified.
6.	Any part of refrigerating circuit (evaporators, air coolers, AHU, condensers or liquid receivers) or piping should not be located in the proximity of heat sources, open flames, operating gas appliance or an operating electric heater.
7.	The user/owner or their authorized representative shall regularly check the alarms, mechanical ventilation and detectors, at least once a year, where as required by national regulations, to ensure their correct functioning.
8.	A logbook shall be maintained. The results of these checks shall be recorded in the logbook.
9.	In case of ventilations in occupied spaces shall be checked to confirm no obstruction.
10.	Before a new refrigerating system is put into service, the person responsible for placing the system in operation should ensure that trained and certified operating personnel are instructed on the basis of the instruction manual about the construction, supervision, operation and maintenance of the refrigerating system, as well as the safety measures to be observed, and the properties and handling of the refrigerant used.
11.	The general requirement of trained and certified personnel are indicated as below: a) Knowledge of legislation, regulations and standards relating to flammable refrigerants; and, b) Detailed knowledge of and skills in handling flammable refrigerants, personal protective equipment, refrigerant leakage prevention, handling of cylinders, charging, leak detection, recovery and disposal; and, c) Able to understand and to apply in practice the requirements in the national legislation, regulations and Standards; and, d) Continuously undergo regular and further training to maintain this expertise.
12.	Air-conditioner piping in the occupied space shall be installed in such a way to protect against accidental damage in operation and service.
13.	Precautions shall be taken to avoid excessive vibration or pulsation to refrigerating piping.
14.	Ensure protection devices, refrigerating piping and fittings are well protected against adverse environmental effects (such as the danger of water collecting and freezing in relief pipes or the accumulation of dirt and debris).
15.	Expansion and contraction of long runs piping in refrigerating systems shall be designed and installed securely (mounted and guarded) to minimize the likelihood hydraulic shock damaging the system.
16.	Protect the refrigerating system from accidental rupture due to moving furniture or reconstruction activities.
17.	To ensure no leaking, field-made refrigerant joints indoors shall be tightness tested. The test method shall have a sensitivity of 5 grams per year of refrigerant or better under a pressure of at least 0,25 times the maximum allowable pressure (>1.04MPa, max 4.15MPa). No leak shall be detected.

 **CAUTION**

General

1.
  - Must ensure the installation of pipe-work shall be kept to a minimum. Avoid use dented pipe and do not allow acute bending.
  - Must ensure that pipe-work shall be protected from physical damage.
  - Must comply with national gas regulations, state municipal rules and legislation. Notify relevant authorities in accordance with all applicable regulations.
  - Must ensure mechanical connections be accessible for maintenance purposes.
  - In cases that require mechanical ventilation, ventilation openings shall be kept clear of obstruction.
  - When disposal of the product, do follow to the precautions in #12 and comply with national regulations.
  - In case of field charge, the effect on refrigerant charge caused by the different pipe length has to be quantified, measured and labelled.  
Always contact to local municipal offices for proper handling.
  - Ensure the actual refrigerant charge is in accordance with the room size within which the refrigerant containing parts are installed.
  - Ensure refrigerant charge not to leak.
  - Wear appropriate protective equipment, including respiratory protection, as conditions warrant.
  - Keep all sources of ignition and hot metal surfaces away.

Servicing

- 2-1. Qualification of workers
  - Any qualified person who is involved with working on or breaking into a refrigerant circuit should hold a current valid certificate from an industry-accredited assessment authority, which authorizes their competence to handle refrigerants safely in accordance with an industry recognized assessment specification.
  - Servicing shall only be performed as recommended by the equipment manufacturer. Maintenance and repair requiring the assistance of other skilled personnel shall be carried out under the supervision of the person competent in the use of flammable refrigerants.
  - Servicing shall be performed only as recommended by the manufacturer.
  - The system is inspected, regularly supervised and maintained by a trained and certified service personnel who is employed by the person user or party responsible.
- 2-2. Checks to the area
  - Prior to beginning work on systems containing flammable refrigerants, safety checks are necessary to ensure that the risk of ignition is minimised.  
For repair to the refrigerating system, the precautions in #2-3 to #2-7 must be followed before conducting work on the system.
- 2-3. Work procedure
  - Work shall be undertaken under a controlled procedure so as to minimize the risk of a flammable gas or vapor being present while the work is being performed.
- 2-4. General work area
  - All maintenance staff and others working in the local area shall be instructed and supervised on the nature of work being carried out.
  - Avoid working in confined spaces. Always ensure away from source, at least 2 meter of safety distance, or zoning of free space area of at least 2 meter in radius.
- 2-5. Checking for presence of refrigerant
  - The area shall be checked with an appropriate refrigerant detector prior to and during work, to ensure the technician is aware of potentially flammable atmospheres.
  - Ensure that the leak detection equipment being used is suitable for use with flammable refrigerants, i.e. non sparking, adequately sealed or intrinsically safe.
  - In case of leakage/spillage happened, immediately ventilate area and stay upwind and away from spill/release.
2.
  - In case of leakage/spillage happened, do notify persons down wind of the leaking/spill, isolate immediate hazard area and keep unauthorized personnel out.
- 2-6. Presence of fire extinguisher
  - If any hot work is to be conducted on the refrigerating equipment or any associated parts, appropriate fire extinguishing equipment shall be available at hand.
  - Have a dry powder or CO<sub>2</sub> fire extinguisher adjacent to the charging area.
- 2-7. No ignition sources
  - No person carrying out work in relation to a refrigeration system which involves exposing any pipe work that contains or has contained flammable refrigerant shall use any sources of ignition in such a manner that it may lead to the risk of fire or explosion. He/She must not be smoking when carrying out such work.
  - All possible ignition sources, including cigarette smoking, should be kept sufficiently far away from the site of installation, repairing, removing and disposal, during which flammable refrigerant can possibly be released to the surrounding space.
  - Prior to work taking place, the area around the equipment is to be surveyed to make sure that there are no flammable hazards or ignition risks.
  - "No Smoking" signs shall be displayed.
- 2-8. Ventilated area
  - Ensure that the area is in the open or that it is adequately ventilated before breaking into the system or conducting any hot work.
  - A degree of ventilation shall continue during the period that the work is carried out.
  - The ventilation should safely disperse any released refrigerant and preferably expel it externally into the atmosphere.
- 2-9. Checks to the refrigerating equipment
  - Where electrical components are being changed, they shall be fit for the purpose and to the correct specification.
  - At all times the manufacturer's maintenance and service guidelines shall be followed.
  - If in doubt consult the manufacturer's technical department for assistance.
  - The following checks shall be applied to installations using flammable refrigerants.
    - The actual refrigerant charge is in accordance with the room size within which the refrigerant containing parts are installed.
    - The ventilation machinery and outlets are operating adequately and are not obstructed.
    - If an indirect refrigerating circuit is being used, the secondary circuit shall be checked for the presence of refrigerant.
    - Marking to the equipment continues to be visible and legible. Markings and signs that are illegible shall be corrected.
    - Refrigerating pipe or components are installed in a position where they are unlikely to be exposed to any substance which may corrode refrigerant containing components, unless the components are constructed of materials which are inherently resistant to being corroded or are properly protected against being so corroded.

 CAUTION

2-10. Checks to electrical devices

- Repair and maintenance to electrical components shall include initial safety checks and component inspection procedures.
  - Initial safety checks shall include but not limit to:-
    - That capacitors are discharged: this shall be done in a safe manner to avoid possibility of sparking.
    - That there is no live electrical components and wiring are exposed while charging, recovering or purging the system.
    - That there is continuity of earth bonding.
- 2.
- At all times the manufacturer's maintenance and service guidelines shall be followed.
  - If in doubt consult the manufacturer's technical department for assistance.
  - If a fault exists that could compromise safety, then no electrical supply shall be connected to the circuit until it is satisfactorily dealt with.
  - If the fault cannot be corrected immediately but it is necessary to continue operation, an adequate temporary solution shall be used.
  - The owner of the equipment must be informed or reported so all parties are advised thereafter.

Repairs to sealed components

- During repairs to sealed components, all electrical supplies shall be disconnected from the equipment being worked upon prior to any removal of sealed covers, etc.
  - If it is absolutely necessary to have an electrical supply to equipment during servicing, then a permanently operating form of leak detection shall be located at the most critical point to warn of a potentially hazardous situation.
  - Particular attention shall be paid to the following to ensure that by working on electrical components, the casing is not altered in such a way that the level of protection is affected. This shall include damage to cables, excessive number of connections, terminals not made to original specification, damage to seals, incorrect fitting of glands, etc.
- 3.
- Ensure that apparatus is mounted securely.
  - Ensure that seals or sealing materials have not degraded such that they no longer serve the purpose of preventing the ingress of flammable atmospheres.
  - Replacement parts shall be in accordance with the manufacturer's specifications.

NOTE: The use of silicon sealant may inhibit the effectiveness of some types of leak detection equipment. Intrinsically safe components do not have to be isolated prior to working on them.

Repair to intrinsically safe components

- Do not apply any permanent inductive or capacitance loads to the circuit without ensuring that this will not exceed the permissible voltage and current permitted for the equipment in use.
- 4.
- Intrinsically safe components are the only types that can be worked on while live in the presence of a flammable atmosphere.
  - The test apparatus shall be at the correct rating.
  - Replace components only with parts specified by the manufacturer. Unspecified parts by manufacturer may result ignition of refrigerant in the atmosphere from a leak.

Cabling

- 5.
- Check that cabling will not be subject to wear, corrosion, excessive pressure, vibration, sharp edges or any other adverse environmental effects.
  - The check shall also take into account the effects of aging or continual vibration from sources such as compressors or fans.

Detection of flammable refrigerants

- Under no circumstances shall potential sources of ignition be used in the searching or detection of refrigerant leaks.
  - A halide torch (or any other detector using a naked flame) shall not be used.
  - The following leak detection methods are deemed acceptable for all refrigerant systems.
    - No leaks shall be detected when using detection equipment with a sensitivity of 5 grams per year of refrigerant or better under a pressure of at least 0,25 times the maximum allowable pressure (>1.04MPa, max 4.15MPa) for example, a universal sniffer.
    - Electronic leak detectors may be used to detect flammable refrigerants, but the sensitivity may not be adequate, or may need re-calibration.  
(Detection equipment shall be calibrated in a refrigerant-free area.)
- 6.
- Ensure that the detector is not a potential source of ignition and is suitable for the refrigerant used.
  - Leak detection equipment shall be set at a percentage of the LFL of the refrigerant and shall be calibrated to the refrigerant employed and the appropriate percentage of gas (25 % maximum) is confirmed.
  - Leak detection fluids are also suitable for use with most refrigerants, for example, bubble method and fluorescent method agents. The use of detergents containing chlorine shall be avoided as the chlorine may react with the refrigerant and corrode the copper pipe-work.
  - If a leak is suspected, all naked flames shall be removed/extinguished.
  - If a leakage of refrigerant is found which requires brazing, all of the refrigerant shall be recovered from the system, or isolated (by means of shut off valves) in a part of the system remote from the leak. The precautions in #7 must be followed to remove the refrigerant.

Removal and evacuation

- When breaking into the refrigerant circuit to make repairs – or for any other purpose – conventional procedures shall be used. However, it is important that best practice is followed since flammability is a consideration. The following procedure shall be adhered to:
- remove refrigerant -> • purge the circuit with inert gas -> • evacuate -> • purge with inert gas -> • open the circuit by cutting or brazing
- 7.
- The refrigerant charge shall be recovered into the correct recovery cylinders.
  - The system shall be "purged" with OFN to render the appliance safe. (remark: OFN = oxygen free nitrogen, type of inert gas)
  - This process may need to be repeated several times.
  - Compressed air or oxygen shall not be used for this task.
  - Purging shall be achieved by breaking the vacuum in the system with OFN and continuing to fill until the working pressure is achieved, then venting to atmosphere, and finally pulling down to a vacuum.
  - This process shall be repeated until no refrigerant is within the system.
  - When the final OFN charge is used, the system shall be vented down to atmospheric pressure to enable work to take place.
  - This operation is absolutely vital if brazing operations on the pipe work are to take place.
  - Ensure that the outlet for the vacuum pump is not close to any ignition sources and there is ventilation available.

**CAUTION****Charging procedures**

- 8.
- In addition to conventional charging procedures, the following requirements shall be followed.
    - Ensure that contamination of different refrigerants does not occur when using charging equipment.
    - Hoses or lines shall be as short as possible to minimize the amount of refrigerant contained in them.
    - Cylinders shall be kept in an appropriate position according to the instructions.
    - Ensure that the refrigeration system is earthed prior to charging the system with refrigerant.
    - Label the system when charging is complete (if not already).
    - Extreme care shall be taken not to over fill the refrigeration system.
  - Prior to recharging the system it shall be pressure tested with OFN (refer to #7).
  - The system shall be leak tested on completion of charging but prior to commissioning.
  - A follow up leak test shall be carried out prior to leaving the site.
  - Electrostatic charge may accumulate and create a hazardous condition when charging and discharging the refrigerant. To avoid fire or explosion, dissipate static electricity during transfer by grounding and bonding containers and equipment before charging/discharging.

**Decommissioning**

- 9.
- Before carrying out this procedure, it is essential that the technician is completely familiar with the equipment and all its details.
  - It is recommended good practice that all refrigerants are recovered safely.
  - Prior to the task being carried out, an oil and refrigerant sample shall be taken in case analysis is required prior to re-use of reclaimed refrigerant.
  - It is essential that electrical power is available before the task is commenced.
    - a) Become familiar with the equipment and its operation.
    - b) Isolate system electrically.
    - c) Before attempting the procedure ensure that:
      - mechanical handling equipment is available, if required, for handling refrigerant cylinders;
      - all personal protective equipment is available and being used correctly;
      - the recovery process is supervised at all times by a competent person;
      - recovery equipment and cylinders conform to the appropriate standards.
  - d) Pump down refrigerant system, if possible.
  - e) If a vacuum is not possible, make a manifold so that refrigerant can be removed from various parts of the system.
  - f) Make sure that cylinder is situated on the scales before recovery takes place.
  - g) Start the recovery machine and operate in accordance with manufacturer's instructions.
  - h) Do not over fill cylinders. (No more than 80 % volume liquid charge).
  - i) Do not exceed the maximum working pressure of the cylinder, even temporarily.
  - j) When the cylinders have been filled correctly and the process completed, make sure that the cylinders and the equipment are removed from site promptly and all isolation valves on the equipment are closed off.
  - k) Recovered refrigerant shall not be charged into another refrigeration system unless it has been cleaned and checked.
  - Electrostatic charge may accumulate and create a hazardous condition when charging or discharging the refrigerant. To avoid fire or explosion, dissipate static electricity during transfer by grounding and bonding containers and equipment before charging/discharging.

**Labelling**

- 10.
- Equipment shall be labelled stating that it has been de-commissioned and emptied of refrigerant.
  - The label shall be dated and signed.
  - Ensure that there are labels on the equipment stating the equipment contains flammable refrigerant.

**Recovery**

- 11.
- When removing refrigerant from a system, either for servicing or decommissioning, it is recommended good practice that all refrigerants are removed safely.
  - When transferring refrigerant into cylinders, ensure that only appropriate refrigerant recovery cylinders are employed.
  - Ensure that the correct number of cylinders for holding the total system charge are available.
  - All cylinders to be used are designated for the recovered refrigerant and labelled for that refrigerant (i.e. special cylinders for the recovery of refrigerant).
  - Cylinders shall be complete with pressure relief valve and associated shut-off valves in good working order.
  - Recovery cylinders are evacuated and, if possible, cooled before recovery occurs.
  - The recovery equipment shall be in good working order with a set of instructions concerning the equipment that is at hand and shall be suitable for the recovery of flammable refrigerants.
  - In addition, a set of calibrated weighing scales shall be available and in good working order.
  - Hoses shall be complete with leak-free disconnect couplings and in good condition.
  - Before using the recovery machine, check that it is in satisfactory working order, has been properly maintained and that any associated electrical components are sealed to prevent ignition in the event of a refrigerant release. Consult manufacturer if in doubt.
  - The recovered refrigerant shall be returned to the refrigerant supplier in the correct recovery cylinder, and the relevant Waste Transfer Note arranged.
  - Do not mix refrigerants in recovery units and especially not in cylinders.
  - If compressors or compressor oils are to be removed, ensure that they have been evacuated to an acceptable level to make certain that flammable refrigerant does not remain within the lubricant.
  - The evacuation process shall be carried out prior to returning the compressor to the suppliers.
  - Only electric heating to the compressor body shall be employed to accelerate this process.
  - When oil is drained from a system, it shall be carried out safely.

### 3. Specifications

Model		Indoor	CS-TZ20WKEW			CS-TZ25WKEW			
		Outdoor	CU-TZ20WKE			CU-TZ25WKE			
Performance Test Condition		EUROVENT			EUROVENT				
Power Supply	Phase, Hz	Single, 50			Single, 50				
	V	230			230				
		Min.	Mid.	Max.	Min.	Mid.	Max.		
Cooling	Capacity	kW	0.75	2.00	2.40	0.85	2.50	3.00	
		BTU/h	2560	6820	8180	2900	8530	10200	
		kcal/h	650	1720	2060	730	2150	2580	
	Running Current	A	–	2.20	–	–	2.90	–	
	Input Power	W	180	490	600	210	650	880	
	Annual Consumption	kWh	–	245	–	–	325	–	
	EER	W/W	4.17	4.08	4.00	4.05	3.85	3.41	
		BTU/hW	14.22	13.92	13.63	13.81	13.12	11.59	
		kcal/hW	3.61	3.51	3.43	3.48	3.31	2.93	
	ErP	Pdesign	kW	2.0			2.5		
		SEER	(W/W)	7.0			7.0		
		Annual Consumption	kWh	100			125		
		Class		A++			A++		
	Power Factor	%	–	97	–	–	97	–	
	Indoor Noise (H / L / QLo)	dB-A	37 / 25 / 20			40 / 26 / 20			
		Power Level dB	53 / – / –			56 / – / –			
Outdoor Noise (H / L)	dB-A	46 / –			47 / –				
	Power Level dB	61 / –			62 / –				
Heating	Capacity	kW	0.70	2.70	3.60	0.80	3.30	4.10	
		BTU/h	2390	9210	12300	2730	11300	14000	
		kcal/h	600	2320	3100	690	2840	3530	
	Running Current	A	–	2.90	–	–	3.50	–	
	Input Power	W	165	650	1.02k	190	790	1.12k	
	COP	W/W	4.24	4.15	3.53	4.21	4.18	3.66	
		BTU/hW	14.48	14.17	12.06	14.37	14.30	12.50	
		kcal/hW	3.64	3.57	3.04	3.63	3.59	3.15	
	ErP	Pdesign	kW	1.9			2.4		
		Tbivalent	°C	-10			-10		
		SCOP	(W/W)	4.6			4.6		
		Annual Consumption	kWh	578			730		
		Class		A++			A++		
	Power Factor	%	–	97	–	–	98	–	
	Indoor Noise (H / L / QLo)	dB-A	38 / 26 / 22			40 / 27 / 22			
		Power Level dB	54 / – / –			56 / – / –			
Outdoor Noise (H / L)	dB-A	47 / –			48 / –				
	Power Level dB	62 / –			63 / –				
Low Temp. : Capacity (kW) / I.Power (W) / COP		2.61 / 900 / 2.90			2.97 / 990 / 3.00				
Extr Low Temp. : Capacity (kW) / I.Power (W) / COP		2.14 / 840 / 2.55			2.70 / 1.01k / 2.67				
Max Current (A) / Max Input Power (W)		4.5 / 1.02k			4.9 / 1.12k				
Starting Current (A)		2.90			3.50				

Model			Indoor	CS-TZ20WKEW	CS-TZ25WKEW	
			Outdoor	CU-TZ20WKE	CU-TZ25WKE	
Compressor	Type			Hermetic Motor (Rotary)	Hermetic Motor (Rotary)	
	Motor Type			Brushless (6 poles)	Brushless (6 poles)	
	Output Power		W	470	550	
Indoor Fan	Type			Cross-Flow Fan	Cross-Flow Fan	
	Material			ASG30	ASG30	
	Motor Type			DC / Transistor (8-poles)	DC / Transistor (8-poles)	
	Input Power		W	43.8	43.8	
	Output Power		W	40	40	
	Speed	QLo	Cool	rpm	550	600
			Heat	rpm	640	660
		Lo	Cool	rpm	680	730
			Heat	rpm	730	770
		Me	Cool	rpm	860	930
			Heat	rpm	890	970
		Hi	Cool	rpm	1020	1140
			Heat	rpm	1060	1180
	SHi	Cool	rpm	1070	1190	
Heat		rpm	1110	1230		
Outdoor Fan	Type			Propeller Fan	Propeller Fan	
	Material			PP	PP	
	Motor Type			DC (8-poles)	DC (8-poles)	
	Input Power		W	-	-	
	Output Power		W	40	40	
	Speed	Hi	Cool	rpm	800	830
Heat			rpm	800	800	
Moisture Removal			L/h (Pt/h)	1.3 (2.7)	1.5 (3.2)	
Indoor Airflow	QLo	Cool	m <sup>3</sup> /min (ft <sup>3</sup> /min)	4.97 (175)	5.30 (187)	
		Heat	m <sup>3</sup> /min (ft <sup>3</sup> /min)	5.99 (211)	5.94 (209)	
	Lo	Cool	m <sup>3</sup> /min (ft <sup>3</sup> /min)	6.44 (227)	6.68 (235)	
		Heat	m <sup>3</sup> /min (ft <sup>3</sup> /min)	7.01 (247)	7.10 (250)	
	Me	Cool	m <sup>3</sup> /min (ft <sup>3</sup> /min)	8.48 (299)	8.80 (310)	
		Heat	m <sup>3</sup> /min (ft <sup>3</sup> /min)	8.82 (311)	9.22 (325)	
	Hi	Cool	m <sup>3</sup> /min (ft <sup>3</sup> /min)	10.30 (365)	11.00 (390)	
		Heat	m <sup>3</sup> /min (ft <sup>3</sup> /min)	10.80 (380)	11.50 (405)	
SHi	Cool	m <sup>3</sup> /min (ft <sup>3</sup> /min)	10.87 (383)	11.56 (408)		
	Heat	m <sup>3</sup> /min (ft <sup>3</sup> /min)	11.32 (399)	11.98 (423)		
Outdoor Airflow	Hi	Cool	m <sup>3</sup> /min (ft <sup>3</sup> /min)	29.70 (1050)	30.00 (1060)	
		Heat	m <sup>3</sup> /min (ft <sup>3</sup> /min)	29.70 (1050)	28.90 (1020)	
Refrigeration Cycle	Control Device			Expansion Valve	Expansion Valve	
	Refrigerant Oil		cm <sup>3</sup>	FW50S (270)	FW50S (270)	
	Refrigerant Type		g (oz)	R32, 540 (19.1)	R32, 670 (23.7)	
F-Gas	GWP			675	675	
	CO <sub>2</sub> eq (ton) (Precharged Amount / Maximum Charged Amount)			0.365 / 0.415	0.452 / 0.503	
Dimension	Height (I/D / O/D)		mm (inch)	290 (11-7/16) / 542 (21-11/32)	290 (11-7/16) / 542 (21-11/32)	
	Width (I/D / O/D)		mm (inch)	779 (30-11/16) / 780 (30-23/32)	779 (30-11/16) / 780 (30-23/32)	
	Depth (I/D / O/D)		mm (inch)	209 (8-1/4) / 289 (11-13/32)	209 (8-1/4) / 289 (11-13/32)	
Weight	Net (I/D / O/D)		kg (lb)	8 (18) / 24 (53)	8 (18) / 25 (55)	

Model		Indoor	CS-TZ20WKEW		CS-TZ25WKEW	
		Outdoor	CU-TZ20WKE		CU-TZ25WKE	
Piping	Pipe Diameter (Liquid / Gas)	mm (inch)	6.35 (1/4) / 9.52 (3/8)		6.35 (1/4) / 9.52 (3/8)	
	Standard length	m (ft)	5.0 (16.4)		5.0 (16.4)	
	Length range (min – max)	m (ft)	3 (9.8) ~ 15 (49.2)		3 (9.8) ~ 15 (49.2)	
	I/D & O/D Height different	m (ft)	15.0 (49.2)		15.0 (49.2)	
	Additional Gas Amount	g/m (oz/ft)	10 (0.1)		10 (0.1)	
	Length for Additional Gas	m (ft)	7.5 (24.6)		7.5 (24.6)	
Drain Hose	Inner Diameter	mm	16		16	
	Length	mm	550		550	
Indoor Heat Exchanger	Fin Material		Aluminium (Pre Coat)		Aluminium (Pre Coat)	
	Fin Type		Slit Fin		Slit Fin	
	Row × Stage × FPI		2 × 14 × 17		2 × 15 × 21	
	Size (W × H × L)	mm	580 × 294 × 25.4		580 × 315 × 25.4	
Outdoor Heat Exchanger	Fin Material		Aluminium (Pre Coat)		Aluminium (Pre Coat)	
	Fin Type		Corrugated Fin		Corrugated Fin	
	Row × Stage × FPI		1 × 24 × 17		1 × 24:12 × 17	
	Size (W × H × L)	mm	18.2 × 504 × 710		36.4 × 504:252 × 713:684	
Air Filter	Material		Polypropelene		Polypropelene	
	Type		One-touch		One-touch	
Power Supply			Indoor		Indoor	
Power Supply Cord		A	Nil		Nil	
Thermostat			Electronic Contol		Electronic Contol	
Protection Device			Electronic Contol		Electronic Contol	
			Dry Bulb	Wet Bulb	Dry Bulb	Wet Bulb
Indoor Operation Range	Cooling	Maximum °C	32	23	32	23
		Minimum °C	16	11	16	11
	Heating	Maximum °C	30	–	30	–
		Minimum °C	16	–	16	–
Outdoor Operation Range	Cooling	Maximum °C	43	26	43	26
		Minimum °C	-10	–	-10	–
	Heating	Maximum °C	24	18	24	18
		Minimum °C	-15	-16	-15	-16

- Cooling capacities are based on indoor temperature of 27°C Dry Bulb (80.6°F Dry Bulb), 19.0°C Wet Bulb (66.2°F Wet Bulb) and outdoor air temperature of 35°C DRY BULB (95°F Dry Bulb), 24°C Wet Bulb (75.2°F Wet Bulb)
- Heating capacities are based on indoor temperature of 20°C Dry Bulb (68°F Dry Bulb) and outdoor air temperature of 7°C Dry Bulb (44.6°F Dry Bulb), 6°C Wet Bulb (42.8°F Wet Bulb)
- Heating low temperature capacity, Input Power and COP measured at 230 V, indoor temperature 20°C, outdoor 2/1°C
- Heating extreme low temperature capacity, Input Power and COP measured at 230 V, indoor temperature 20°C, outdoor -7/-8°C
- Standby power consumption ≤2.0W (when switched OFF by remote control, except under self protection control).
- Specifications are subjected to change without prior notice for further improvement.

Model		Indoor	CS-TZ35WKEW			CS-TZ42WKEW				
		Outdoor	CU-TZ35WKE			CU-TZ42WKE				
Performance Test Condition			EUROVENT			EUROVENT				
Power Supply		Phase, Hz	Single, 50			Single, 50				
		V	230			230				
			Min.	Mid.	Max.	Min.	Mid.	Max.		
Cooling	Capacity		kW	0.85	3.50	3.90	0.85	4.20	4.60	
			BTU/h	2900	11900	13300	2900	14300	15700	
			kcal/h	730	3010	3350	730	3610	3960	
	Running Current		A	–	4.30	–	–	5.50	–	
	Input Power		W	235	980	1.16k	235	1.25k	1.64k	
	Annual Consumption		kWh	–	490	–	–	625	–	
	EER		W/W	3.62	3.57	3.36	3.62	3.36	2.80	
			BTU/hW	12.34	12.14	11.47	12.34	11.44	9.57	
			kcal/hW	3.11	3.07	2.89	3.11	2.89	2.41	
	ErP	Pdesign	kW	3.5			4.2			
		SEER	(W/W)	6.8			6.4			
		Annual Consumption	kWh	180			230			
		Class		A++			A++			
	Power Factor		%	–	99	–	–	99	–	
	Indoor Noise (H / L / QLo)		dB-A	42 / 30 / 20			44 / 31 / 29			
			Power Level dB	58 / – / –			60 / – / –			
	Outdoor Noise (H / L)		dB-A	48 / –			49 / –			
			Power Level dB	63 / –			64 / –			
	Heating	Capacity		kW	0.80	4.00	5.10	0.80	5.00	6.80
				BTU/h	2730	13600	17400	2730	17100	23200
kcal/h				690	3440	4390	690	4300	5850	
Running Current		A	–	4.35	–	–	5.90	–		
Input Power		W	195	990	1.38k	195	1.34k	2.04k		
COP		W/W	4.10	4.04	3.70	4.10	3.73	3.33		
		BTU/hW	14.00	13.74	12.61	14.00	12.76	11.37		
		kcal/hW	3.54	3.47	3.18	3.54	3.21	2.87		
ErP		Pdesign	kW	2.8			3.6			
		Tbivalent	°C	-10			-10			
		SCOP	(W/W)	4.6			4.0			
		Annual Consumption	kWh	852			1260			
		Class		A++			A+			
Power Factor		%	–	99	–	–	99	–		
Indoor Noise (H / L / QLo)		dB-A	42 / 33 / 22			44 / 35 / 28				
		Power Level dB	58 / – / –			60 / – / –				
Outdoor Noise (H / L)		dB-A	50 / –			51 / –				
		Power Level dB	65 / –			66 / –				
Low Temp. : Capacity (kW) / I.Power (W) / COP			3.70 / 1.22k / 3.03			4.93 / 1.81k / 2.72				
Extr Low Temp. : Capacity (kW) / I.Power (W) / COP			3.30 / 1.31k / 2.52			3.90 / 1.70k / 2.29				
Max Current (A) / Max Input Power (W)			6.2 / 1.38k			9.0 / 2.04k				
Starting Current (A)			4.35			5.90				

Model			Indoor	CS-TZ35WKEW	CS-TZ42WKEW	
			Outdoor	CU-TZ35WKE	CU-TZ42WKE	
Compressor	Type			Hermetic Motor (Rotary)	Hermetic Motor (Rotary)	
	Motor Type			Brushless (6 poles)	Brushless (6 poles)	
	Output Power		W	700	800	
Indoor Fan	Type			Cross-Flow Fan	Cross-Flow Fan	
	Material			ASG30	ASG30	
	Motor Type			DC / Transistor (8-poles)	DC / Transistor (8-poles)	
	Input Power		W	43.8	43.8	
	Output Power		W	40	40	
	Speed	QLo	Cool	rpm	640	830
			Heat	rpm	660	810
		Lo	Cool	rpm	850	880
			Heat	rpm	970	1010
		Me	Cool	rpm	1030	1080
			Heat	rpm	1110	1170
		Hi	Cool	rpm	1210	1280
			Heat	rpm	1260	1340
SHi	Cool	rpm	1260	1330		
	Heat	rpm	1310	1400		
Outdoor Fan	Type			Propeller Fan	Propeller Fan	
	Material			PP	PP	
	Motor Type			DC (8-poles)	DC (8-poles)	
	Input Power		W	-	-	
	Output Power		W	40	40	
	Speed	Hi	Cool	rpm	830	880
Heat			rpm	860	890	
Moisture Removal			L/h (Pt/h)	2.0 (4.2)	2.4 (5.1)	
Indoor Airflow	QLo	Cool	m <sup>3</sup> /min (ft <sup>3</sup> /min)	5.73 (202)	7.74 (273)	
		Heat	m <sup>3</sup> /min (ft <sup>3</sup> /min)	5.94 (209)	7.53 (265)	
	Lo	Cool	m <sup>3</sup> /min (ft <sup>3</sup> /min)	7.95 (280)	8.27 (292)	
		Heat	m <sup>3</sup> /min (ft <sup>3</sup> /min)	9.22 (325)	9.65 (340)	
	Me	Cool	m <sup>3</sup> /min (ft <sup>3</sup> /min)	9.86 (348)	10.39 (366)	
		Heat	m <sup>3</sup> /min (ft <sup>3</sup> /min)	10.71 (378)	11.34 (400)	
	Hi	Cool	m <sup>3</sup> /min (ft <sup>3</sup> /min)	11.80 (415)	12.50 (440)	
		Heat	m <sup>3</sup> /min (ft <sup>3</sup> /min)	12.30 (435)	13.20 (465)	
SHi	Cool	m <sup>3</sup> /min (ft <sup>3</sup> /min)	12.30 (435)	13.04 (460)		
	Heat	m <sup>3</sup> /min (ft <sup>3</sup> /min)	12.83 (453)	13.78 (486)		
Outdoor Airflow	Hi	Cool	m <sup>3</sup> /min (ft <sup>3</sup> /min)	28.70 (1015)	30.40 (1075)	
		Heat	m <sup>3</sup> /min (ft <sup>3</sup> /min)	29.70 (1050)	30.80 (1085)	
Refrigeration Cycle	Control Device			Expansion Valve	Expansion Valve	
	Refrigerant Oil		cm <sup>3</sup>	FW50S (320)	FW50S (370)	
	Refrigerant Type		g (oz)	R32, 770 (27.2)	R32, 790 (27.9)	
F-Gas	GWP			675	675	
	CO2eq (ton) (Precharged Amount / Maximum Charged Amount)			0.520 / 0.570	0.533 / 0.584	
Dimension	Height (I/D / O/D)		mm (inch)	290 (11-7/16) / 542 (21-11/32)	290 (11-7/16) / 542 (21-11/32)	
	Width (I/D / O/D)		mm (inch)	779 (30-11/16) / 780 (30-23/32)	779 (30-11/16) / 780 (30-23/32)	
	Depth (I/D / O/D)		mm (inch)	209 (8-1/4) / 289 (11-13/32)	209 (8-1/4) / 289 (11-13/32)	
Weight	Net (I/D / O/D)		kg (lb)	8 (18) / 31 (68)	8 (18) / 31 (68)	

Model		Indoor	CS-TZ35WKEW		CS-TZ42WKEW	
		Outdoor	CU-TZ35WKE		CU-TZ42WKE	
Piping	Pipe Diameter (Liquid / Gas)	mm (inch)	6.35 (1/4) / 9.52 (3/8)		6.35 (1/4) / 12.70 (1/2)	
	Standard length	m (ft)	5.0 (16.4)		5.0 (16.4)	
	Length range (min – max)	m (ft)	3 (9.8) ~ 15 (49.2)		3 (9.8) ~ 15 (49.2)	
	I/D & O/D Height different	m (ft)	15.0 (49.2)		15.0 (49.2)	
	Additional Gas Amount	g/m (oz/ft)	10 (0.1)		10 (0.1)	
	Length for Additional Gas	m (ft)	7.5 (24.6)		7.5 (24.6)	
Drain Hose	Inner Diameter	mm	16		16	
	Length	mm	550		550	
Indoor Heat Exchanger	Fin Material		Aluminium (Pre Coat)		Aluminium (Pre Coat)	
	Fin Type		Slit Fin		Slit Fin	
	Row × Stage × FPI		2 × 15 × 21		2 × 15 × 21	
	Size (W × H × L)	mm	580 × 315 × 25.4		580 × 315 × 25.4	
Outdoor Heat Exchanger	Fin Material		Aluminium (Pre Coat)		Aluminium (Pre Coat)	
	Fin Type		Corrugated Fin		Corrugated Fin	
	Row × Stage × FPI		2 × 24 × 17		2 × 24 × 17	
	Size (W × H × L)	mm	36.4 × 504 × 713:684		36.4 × 504 × 713:684	
Air Filter	Material		Polypropelene		Polypropelene	
	Type		One-touch		One-touch	
Power Supply			Indoor		Indoor	
Power Supply Cord		A	Nil		Nil	
Thermostat			Electronic Contol		Electronic Contol	
Protection Device			Electronic Contol		Electronic Contol	
			Dry Bulb	Wet Bulb	Dry Bulb	Wet Bulb
Indoor Operation Range	Cooling	Maximum °C	32	23	32	23
		Minimum °C	16	11	16	11
	Heating	Maximum °C	30	–	30	–
		Minimum °C	16	–	16	–
Outdoor Operation Range	Cooling	Maximum °C	43	26	43	26
		Minimum °C	-10	–	-10	–
	Heating	Maximum °C	24	18	24	18
		Minimum °C	-15	-16	-15	-16

1. Cooling capacities are based on indoor temperature of 27°C Dry Bulb (80.6°F Dry Bulb), 19.0°C Wet Bulb (66.2°F Wet Bulb) and outdoor air temperature of 35°C DRY BULB (95°F Dry Bulb), 24°C Wet Bulb (75.2°F Wet Bulb)
2. Heating capacities are based on indoor temperature of 20°C Dry Bulb (68°F Dry Bulb) and outdoor air temperature of 7°C Dry Bulb (44.6°F Dry Bulb), 6°C Wet Bulb (42.8°F Wet Bulb)
3. Heating low temperature capacity, Input Power and COP measured at 230 V, indoor temperature 20°C, outdoor 2/1°C
4. Heating extreme low temperature capacity, Input Power and COP measured at 230 V, indoor temperature 20°C, outdoor -7/-8°C
5. Standby power consumption ≤2.0W (when switched OFF by remote control, except under self protection control).
6. Specifications are subjected to change without prior notice for further improvement.

Model		Indoor	CS-TZ50WKEW			CS-TZ60WKEW				
		Outdoor	CU-TZ50WKE			CU-TZ60WKE				
Performance Test Condition			EUROVENT			EUROVENT				
Power Supply		Phase, Hz	Single, 50			Single, 50				
		V	230			230				
			Min.	Mid.	Max.	Min.	Mid.	Max.		
Cooling	Capacity		kW	0.98	5.00	5.60	0.98	6.00	6.60	
			BTU/h	3340	17100	19100	3340	20500	22500	
			kcal/h	840	4300	4820	840	5160	5680	
	Running Current		A	–	7.10	–	–	8.20	–	
	Input Power		W	250	1.60k	1.90k	250	1.85k	2.30k	
	Annual Consumption		kWh	–	800	–	–	925	–	
	EER		W/W	3.92	3.13	2.95	3.92	3.24	2.87	
			BTU/hW	13.36	10.69	10.05	13.36	11.08	9.78	
			kcal/hW	3.36	2.69	2.54	3.36	2.79	2.47	
	ErP	Pdesign	kW	5.0			6.0			
		SEER	(W/W)	6.9			6.8			
		Annual Consumption	kWh	254			309			
		Class		A++			A++			
	Power Factor		%	–	98	–	–	98	–	
	Indoor Noise (H / L / QLo)		dB-A	44 / 37 / 33			45 / 37 / 34			
			Power Level dB	60 / – / –			60 / – / –			
	Outdoor Noise (H / L)		dB-A	48 / –			49 / –			
			Power Level dB	63 / –			64 / –			
	Heating	Capacity		kW	0.98	5.80	7.50	0.98	7.00	8.20
				BTU/h	3340	19800	25600	3340	23900	28000
kcal/h				840	4990	6450	840	6020	7050	
Running Current		A	–	7.60	–	–	8.40	–		
Input Power		W	210	1.70k	2.30k	210	1.90k	2.30k		
COP		W/W	4.67	3.41	3.26	4.67	3.68	3.57		
		BTU/hW	15.90	11.65	11.13	15.90	12.58	12.17		
		kcal/hW	4.00	2.94	2.80	4.00	3.17	3.07		
ErP		Pdesign	kW	4.0			4.4			
		Tbivalent	°C	-10			-10			
		SCOP	(W/W)	4.5			4.3			
		Annual Consumption	kWh	1244			1433			
		Class		A+			A+			
Power Factor		%	–	97	–	–	98	–		
Indoor Noise (H / L / QLo)		dB-A	44 / 37 / 33			45 / 37 / 34				
		Power Level dB	60 / – / –			61 / – / –				
Outdoor Noise (H / L)		dB-A	49 / –			51 / –				
		Power Level dB	64 / –			66 / –				
Low Temp. : Capacity (kW) / I.Power (W) / COP			5.43 / 2.04k / 2.66			5.94 / 2.04k / 2.91				
Extr Low Temp. : Capacity (kW) / I.Power (W) / COP			4.62 / 2.00k / 2.31			4.90 / 1.95k / 2.51				
Max Current (A) / Max Input Power (W)			10.5 / 2.30k			11.2 / 2.50k				
Starting Current (A)			7.60			8.40				

Model			Indoor	CS-TZ50WKEW	CS-TZ60WKEW	
			Outdoor	CU-TZ50WKE	CU-TZ60WKE	
Compressor	Type			Hermetic Motor (Rotary)	Hermetic Motor (Rotary)	
	Motor Type			Brushless (4 poles)	Brushless (4 poles)	
	Output Power		W	900	900	
Indoor Fan	Type			Cross-Flow Fan	Cross-Flow Fan	
	Material			ASG30	ASG33	
	Motor Type			DC / Transistor (8-poles)	DC / Transistor (8-poles)	
	Input Power		W	43.8	89.0	
	Output Power		W	40	40	
	Speed	QLo	Cool	rpm	930	790
			Heat	rpm	970	840
		Lo	Cool	rpm	1040	870
			Heat	rpm	1090	940
		Me	Cool	rpm	1160	1030
			Heat	rpm	1210	1080
		Hi	Cool	rpm	1280	1180
			Heat	rpm	1340	1230
	SHi	Cool	rpm	1330	1230	
Heat		rpm	1420	1280		
Outdoor Fan	Type			Propeller Fan	Propeller Fan	
	Material			PP	PP	
	Motor Type			DC (8-poles)	DC (8-poles)	
	Input Power		W	-	-	
	Output Power		W	40	40	
	Speed	Hi	Cool	rpm	820	850
Heat			rpm	820	850	
Moisture Removal			L/h (Pt/h)	2.8 (5.9)	3.3 (7.0)	
Indoor Airflow	QLo	Cool	m <sup>3</sup> /min (ft <sup>3</sup> /min)	8.80 (310)	13.01 (459)	
		Heat	m <sup>3</sup> /min (ft <sup>3</sup> /min)	9.22 (324)	14.01 (494)	
	Lo	Cool	m <sup>3</sup> /min (ft <sup>3</sup> /min)	9.97 (352)	14.62 (516)	
		Heat	m <sup>3</sup> /min (ft <sup>3</sup> /min)	10.50 (370)	16.02 (565)	
	Me	Cool	m <sup>3</sup> /min (ft <sup>3</sup> /min)	11.24 (396)	17.83 (629)	
		Heat	m <sup>3</sup> /min (ft <sup>3</sup> /min)	11.77 (415)	18.84 (665)	
	Hi	Cool	m <sup>3</sup> /min (ft <sup>3</sup> /min)	12.50 (440)	20.90 (740)	
		Heat	m <sup>3</sup> /min (ft <sup>3</sup> /min)	13.20 (465)	21.90 (775)	
SHi	Cool	m <sup>3</sup> /min (ft <sup>3</sup> /min)	13.04 (460)	21.85 (771)		
	Heat	m <sup>3</sup> /min (ft <sup>3</sup> /min)	13.99 (494)	22.86 (807)		
Outdoor Airflow	Hi	Cool	m <sup>3</sup> /min (ft <sup>3</sup> /min)	32.70 (1155)	34.00 (1200)	
		Heat	m <sup>3</sup> /min (ft <sup>3</sup> /min)	32.70 (1155)	34.00 (1200)	
Refrigeration Cycle	Control Device			Expansion Valve	Expansion Valve	
	Refrigerant Oil		cm <sup>3</sup>	FW50S (450)	FW50S (450)	
	Refrigerant Type		g (oz)	R32, 1.14k (40.2)	R32, 1.22k (43.1)	
F-Gas	GWP			675	675	
	CO <sub>2</sub> eq (ton) (Precharged Amount / Maximum Charged Amount)			0.770 / 0.896	0.824 / 1.026	
Dimension	Height (I/D / O/D)		mm (inch)	290 (11-7/16) / 619 (24-3/8)	302 (11-29/32) / 619 (24-3/8)	
	Width (I/D / O/D)		mm (inch)	779 (30-11/16) / 824 (32-15/32)	1102 (43-13/32) / 824 (32-15/32)	
	Depth (I/D / O/D)		mm (inch)	209 (8-1/4) / 299 (11-25/32)	244 (9-5/8) / 299 (11-25/32)	
Weight	Net (I/D / O/D)		kg (lb)	8 (18) / 36 (79)	13 (29) / 36 (79)	

Model		Indoor	CS-TZ50WKEW		CS-TZ60WKEW	
		Outdoor	CU-TZ50WKE		CU-TZ60WKE	
Piping	Pipe Diameter (Liquid / Gas)	mm (inch)	6.35 (1/4) / 12.70 (1/2)		6.35 (1/4) / 12.70 (1/2)	
	Standard length	m (ft)	5.0 (16.4)		5.0 (16.4)	
	Length range (min – max)	m (ft)	3 (9.8) ~ 20 (65.6)		3 (9.8) ~ 30 (98.4)	
	I/D & O/D Height different	m (ft)	15.0 (49.2)		15.0 (49.2)	
	Additional Gas Amount	g/m (oz/ft)	15 (0.2)		15 (0.2)	
	Length for Additional Gas	m (ft)	7.5 (24.6)		10.0 (32.8)	
Drain Hose	Inner Diameter	mm	16		16	
	Length	mm	550		650	
Indoor Heat Exchanger	Fin Material		Aluminium (Pre Coat)		Aluminium (Pre Coat)	
	Fin Type		Slit Fin		Slit Fin	
	Row × Stage × FPI		2 × 15 × 21		2 × 17 × 21	
	Size (W × H × L)	mm	580 × 315 × 25.4		836.7 × 357 × 25.4	
Outdoor Heat Exchanger	Fin Material		Aluminium (Pre Coat)		Aluminium (Pre Coat)	
	Fin Type		Corrugated Fin		Corrugated Fin	
	Row × Stage × FPI		2 × 28 × 17		2 × 28 × 17	
	Size (W × H × L)	mm	36.38 × 588 × 856.3:827.7		36.38 × 588 × 856.3:827.7	
Air Filter	Material		Polypropelene		Polypropelene	
	Type		One-touch		One-touch	
Power Supply			Indoor		Indoor	
Power Supply Cord		A	Nil		Nil	
Thermostat			Electronic Contol		Electronic Contol	
Protection Device			Electronic Contol		Electronic Contol	
			Dry Bulb	Wet Bulb	Dry Bulb	Wet Bulb
Indoor Operation Range	Cooling	Maximum °C	32	23	32	23
		Minimum °C	16	11	16	11
	Heating	Maximum °C	30	–	30	–
		Minimum °C	16	–	16	–
Outdoor Operation Range	Cooling	Maximum °C	43	26	43	26
		Minimum °C	-10	–	-10	–
	Heating	Maximum °C	24	18	24	18
		Minimum °C	-15	-16	-15	-16

- Cooling capacities are based on indoor temperature of 27°C Dry Bulb (80.6°F Dry Bulb), 19.0°C Wet Bulb (66.2°F Wet Bulb) and outdoor air temperature of 35°C DRY BULB (95°F Dry Bulb), 24°C Wet Bulb (75.2°F Wet Bulb)
- Heating capacities are based on indoor temperature of 20°C Dry Bulb (68°F Dry Bulb) and outdoor air temperature of 7°C Dry Bulb (44.6°F Dry Bulb), 6°C Wet Bulb (42.8°F Wet Bulb)
- Heating low temperature capacity, Input Power and COP measured at 230 V, indoor temperature 20°C, outdoor 2/1°C
- Heating extreme low temperature capacity, Input Power and COP measured at 230 V, indoor temperature 20°C, outdoor -7/-8°C
- Standby power consumption ≤2.0W (when switched OFF by remote control, except under self protection control).
- Specifications are subjected to change without prior notice for further improvement.

Model		Indoor	CS-TZ71WKEW				
		Outdoor	CU-TZ71WKE				
Performance Test Condition		EUROVENT					
Power Supply		Phase, Hz	Single, 50				
		V	230				
		Min.	Mid.	Max.			
Cooling	Capacity		kW	0.98	7.10	8.20	
			BTU/h	3340	24200	28000	
			kcal/h	840	6110	7050	
	Running Current		A	–	9.90	–	
	Input Power		W	420	2.24k	2.75k	
	Annual Consumption		kWh	–	1120	–	
	EER		W/W	2.33	3.17	2.98	
			BTU/hW	7.95	10.80	10.18	
			kcal/hW	2.00	2.73	2.56	
	ErP	Pdesign	kW	7.1			
		SEER	(W/W)	6.2			
		Annual Consumption	kWh	401			
		Class		A++			
	Power Factor		%	–	98	–	
	Indoor Noise (H / L / QLo)		dB-A	47 / 38 / 35			
			Power Level dB	63 / – / –			
	Outdoor Noise (H / L)		dB-A	52 / –			
			Power Level dB	66 / –			
	Heating	Capacity		kW	0.98	8.60	9.90
				BTU/h	3340	29300	33800
kcal/h				840	7400	8510	
Running Current		A	–	10.90	–		
Input Power		W	400	2.45k	2.85k		
COP		W/W	2.45	3.51	3.47		
		BTU/hW	8.35	11.96	11.86		
		kcal/hW	2.10	3.02	2.99		
ErP		Pdesign	kW	5.5			
		Tbivalent	°C	-10			
		SCOP	(W/W)	4.0			
		Annual Consumption	kWh	1925			
		Class		A+			
Power Factor		%	–	98	–		
Indoor Noise (H / L / QLo)		dB-A	47 / 38 / 35				
		Power Level dB	63 / – / –				
Outdoor Noise (H / L)		dB-A	54 / –				
		Power Level dB	68 / –				
Low Temp. : Capacity (kW) / I.Power (W) / COP		7.17 / 2.52k / 2.85					
Extr Low Temp. : Capacity (kW) / I.Power (W) / COP		6.13 / 2.48k / 2.47					
Max Current (A) / Max Input Power (W)		14.8 / 3.22k					
Starting Current (A)		10.90					

Model			Indoor	CS-TZ71WKEW	
			Outdoor	CU-TZ71WKE	
Compressor	Type			Hermetic Motor (Rotary)	
	Motor Type			Brushless (4 poles)	
	Output Power		W	1.70k	
Indoor Fan	Type			Cross-Flow Fan	
	Material			ASG33	
	Motor Type			DC / Transistor (8-poles)	
	Input Power		W	105.0	
	Output Power		W	40	
	Speed	QLo	Cool	rpm	810
			Heat	rpm	860
		Lo	Cool	rpm	890
			Heat	rpm	960
		Me	Cool	rpm	1070
			Heat	rpm	1120
		Hi	Cool	rpm	1240
			Heat	rpm	1280
	SHi	Cool	rpm	1290	
Heat		rpm	1330		
Outdoor Fan	Type			Propeller Fan	
	Material			PP	
	Motor Type			DC (8-poles)	
	Input Power		W	-	
	Output Power		W	40	
	Speed	Hi	Cool	rpm	820
Heat			rpm	840	
Moisture Removal			L/h (Pt/h)	4.1 (8.7)	
Indoor Airflow	QLo	Cool	m <sup>3</sup> /min (ft <sup>3</sup> /min)	13.41 (473)	
		Heat	m <sup>3</sup> /min (ft <sup>3</sup> /min)	14.42 (509)	
	Lo	Cool	m <sup>3</sup> /min (ft <sup>3</sup> /min)	15.02 (530)	
		Heat	m <sup>3</sup> /min (ft <sup>3</sup> /min)	16.43 (580)	
	Me	Cool	m <sup>3</sup> /min (ft <sup>3</sup> /min)	18.64 (658)	
		Heat	m <sup>3</sup> /min (ft <sup>3</sup> /min)	19.64 (693)	
	Hi	Cool	m <sup>3</sup> /min (ft <sup>3</sup> /min)	22.10 (780)	
		Heat	m <sup>3</sup> /min (ft <sup>3</sup> /min)	22.90 (810)	
SHi	Cool	m <sup>3</sup> /min (ft <sup>3</sup> /min)	23.06 (814)		
	Heat	m <sup>3</sup> /min (ft <sup>3</sup> /min)	23.86 (842)		
Outdoor Airflow	Hi	Cool	m <sup>3</sup> /min (ft <sup>3</sup> /min)	44.7 (1580)	
		Heat	m <sup>3</sup> /min (ft <sup>3</sup> /min)	45.9 (1620)	
Refrigeration Cycle	Control Device			Expansion Valve	
	Refrigerant Oil		cm <sup>3</sup>	FW50S (800)	
	Refrigerant Type		g (oz)	R32, 1.32k (46.6)	
F-Gas	GWP			675	
	CO2eq (ton) (Precharged Amount / Maximum Charged Amount)			0.891 / 1.229	
Dimension	Height (I/D / O/D)		mm (inch)	302 (11-29/32) / 695 (27-3/8)	
	Width (I/D / O/D)		mm (inch)	1102 (43-13/32) / 875 (34-15/32)	
	Depth (I/D / O/D)		mm (inch)	244 (9-5/8) / 320 (12-5/8)	
Weight	Net (I/D / O/D)		kg (lb)	13 (29) / 50 (110)	

Model		Indoor	CS-TZ71WKEW	
		Outdoor	CU-TZ71WKE	
Piping	Pipe Diameter (Liquid / Gas)	mm (inch)	6.35 (1/4) / 15.88 (5/8)	
	Standard length	m (ft)	5.0 (16.4)	
	Length range (min – max)	m (ft)	3 (9.8) ~ 30 (98.4)	
	I/D & O/D Height different	m (ft)	20.0 (65.6)	
	Additional Gas Amount	g/m (oz/ft)	25 (0.3)	
	Length for Additional Gas	m (ft)	10 (32.8)	
Drain Hose	Inner Diameter	mm	16	
	Length	mm	650	
Indoor Heat Exchanger	Fin Material		Aluminium (Pre Coat)	
	Fin Type		Slit Fin	
	Row × Stage × FPI		2 × 17 × 21	
	Size (W × H × L)	mm	836.7 × 357 × 25.4	
Outdoor Heat Exchanger	Fin Material		Aluminium (Pre Coat)	
	Fin Type		Corrugated Fin	
	Row × Stage × FPI		2 × 31 × 19	
	Size (W × H × L)	mm	36.4 × 651 × 904.5:874.5	
Air Filter	Material		Polypropelene	
	Type		One-touch	
Power Supply			Indoor	
Power Supply Cord		A	Nil	
Thermostat			Electronic Contol	
Protection Device			Electronic Contol	
			Dry Bulb	Wet Bulb
Indoor Operation Range	Cooling	Maximum °C	32	23
		Minimum °C	16	11
	Heating	Maximum °C	30	–
		Minimum °C	16	–
Outdoor Operation Range	Cooling	Maximum °C	43	26
		Minimum °C	-10	–
	Heating	Maximum °C	24	18
		Minimum °C	-15	-16

- Cooling capacities are based on indoor temperature of 27°C Dry Bulb (80.6°F Dry Bulb), 19.0°C Wet Bulb (66.2°F Wet Bulb) and outdoor air temperature of 35°C DRY BULB (95°F Dry Bulb), 24°C Wet Bulb (75.2°F Wet Bulb)
- Heating capacities are based on indoor temperature of 20°C Dry Bulb (68°F Dry Bulb) and outdoor air temperature of 7°C Dry Bulb (44.6°F Dry Bulb), 6°C Wet Bulb (42.8°F Wet Bulb)
- Heating low temperature capacity, Input Power and COP measured at 230 V, indoor temperature 20°C, outdoor 2/1°C
- Heating extreme low temperature capacity, Input Power and COP measured at 230 V, indoor temperature 20°C, outdoor -7/-8°C
- Standby power consumption ≤2.0W (when switched OFF by remote control, except under self protection control).
- Specifications are subjected to change without prior notice for further improvement.

Model		Indoor	CS-RZ20WKEW			CS-RZ25WKEW				
		Outdoor	CU-RZ20WKE			CU-RZ25WKE				
Performance Test Condition			EUROVENT			EUROVENT				
Power Supply		Phase, Hz	Single, 50			Single, 50				
		V	230			230				
			Min.	Mid.	Max.	Min.	Mid.	Max.		
Cooling	Capacity		kW	0.75	2.00	2.40	0.85	2.50	3.00	
			BTU/h	2560	6820	8180	2900	8530	10200	
			kcal/h	650	1720	2060	730	2150	2580	
	Running Current		A	–	2.30	–	–	2.95	–	
	Input Power		W	180	510	620	210	660	890	
	Annual Consumption		kWh	–	255	–	–	330	–	
	EER		W/W	4.17	3.92	3.87	4.05	3.79	3.37	
			BTU/hW	14.22	13.37	13.19	13.81	12.92	11.46	
			kcal/hW	3.61	3.37	3.32	3.48	3.26	2.90	
	ErP	Pdesign	kW	2.0			2.5			
		SEER	(W/W)	6.5			6.4			
		Annual Consumption	kWh	108			137			
		Class		A++			A++			
	Power Factor		%	–	96	–	–	97	–	
	Indoor Noise (H / L / QLo)		dB-A	37 / 25 / 20			40 / 26 / 20			
			Power Level dB	53 / – / –			56 / – / –			
	Outdoor Noise (H / L)		dB-A	46 / –			47 / –			
			Power Level dB	61 / –			62 / –			
	Heating	Capacity		kW	0.70	2.70	3.60	0.80	3.30	4.10
				BTU/h	2390	9210	12300	2730	11300	14000
kcal/h				600	2320	3100	690	2840	3530	
Running Current		A	–	3.00	–	–	3.55	–		
Input Power		W	165	670	1.04k	190	800	1.13k		
COP		W/W	4.24	4.03	3.46	4.21	4.13	3.63		
		BTU/hW	14.48	13.75	11.83	14.37	14.13	12.39		
		kcal/hW	3.64	3.46	2.98	3.63	3.55	3.12		
ErP		Pdesign	kW	1.9			2.4			
		Tbivalent	°C	-10			-10			
		SCOP	(W/W)	4.1			4.6			
		Annual Consumption	kWh	649			730			
		Class		A+			A++			
Power Factor		%	–	97	–	–	98	–		
Indoor Noise (H / L / QLo)		dB-A	38 / 26 / 22			40 / 27 / 22				
		Power Level dB	54 / – / –			56 / – / –				
Outdoor Noise (H / L)		dB-A	47 / –			48 / –				
		Power Level dB	62 / –			63 / –				
Low Temp. : Capacity (kW) / I.Power (W) / COP			2.61 / 920 / 2.84			2.97 / 1.00k / 2.97				
Extr Low Temp. : Capacity (kW) / I.Power (W) / COP			2.14 / 860 / 2.49			2.70 / 1.02k / 2.65				
Max Current (A) / Max Input Power (W)			4.6 / 1.04k			5.0 / 1.13k				
Starting Current (A)			3.00			3.55				

Model			Indoor	CS-RZ20WKEW	CS-RZ25WKEW	
			Outdoor	CU-RZ20WKE	CU-RZ25WKE	
Compressor	Type			Hermetic Motor (Rotary)	Hermetic Motor (Rotary)	
	Motor Type			Brushless (6 poles)	Brushless (6 poles)	
	Output Power		W	470	550	
Indoor Fan	Type			Cross-Flow Fan	Cross-Flow Fan	
	Material			ASG30	ASG30	
	Motor Type			DC / Transistor (8-poles)	DC / Transistor (8-poles)	
	Input Power		W	43.8	43.8	
	Output Power		W	40	40	
	Speed	QLo	Cool	rpm	550	600
			Heat	rpm	640	660
		Lo	Cool	rpm	680	730
			Heat	rpm	730	770
		Me	Cool	rpm	860	930
			Heat	rpm	890	970
		Hi	Cool	rpm	1020	1140
			Heat	rpm	1060	1180
SHi	Cool	rpm	1070	1190		
	Heat	rpm	1110	1230		
Outdoor Fan	Type			Propeller Fan	Propeller Fan	
	Material			PP	PP	
	Motor Type			DC (8-poles)	DC (8-poles)	
	Input Power		W	-	-	
	Output Power		W	40	40	
	Speed	Hi	Cool	rpm	800	830
Heat			rpm	800	800	
Moisture Removal			L/h (Pt/h)	1.3 (2.7)	1.5 (3.2)	
Indoor Airflow	QLo	Cool	m <sup>3</sup> /min (ft <sup>3</sup> /min)	4.97 (175)	5.30 (187)	
		Heat	m <sup>3</sup> /min (ft <sup>3</sup> /min)	5.99 (211)	5.94 (209)	
	Lo	Cool	m <sup>3</sup> /min (ft <sup>3</sup> /min)	6.44 (227)	6.68 (235)	
		Heat	m <sup>3</sup> /min (ft <sup>3</sup> /min)	7.01 (247)	7.10 (250)	
	Me	Cool	m <sup>3</sup> /min (ft <sup>3</sup> /min)	8.48 (299)	8.80 (310)	
		Heat	m <sup>3</sup> /min (ft <sup>3</sup> /min)	8.82 (311)	9.22 (325)	
	Hi	Cool	m <sup>3</sup> /min (ft <sup>3</sup> /min)	10.30 (365)	11.00 (390)	
		Heat	m <sup>3</sup> /min (ft <sup>3</sup> /min)	10.80 (380)	11.50 (405)	
SHi	Cool	m <sup>3</sup> /min (ft <sup>3</sup> /min)	10.87 (383)	11.56 (408)		
	Heat	m <sup>3</sup> /min (ft <sup>3</sup> /min)	11.32 (399)	11.98 (423)		
Outdoor Airflow	Hi	Cool	m <sup>3</sup> /min (ft <sup>3</sup> /min)	29.70 (1050)	30.00 (1060)	
		Heat	m <sup>3</sup> /min (ft <sup>3</sup> /min)	29.70 (1050)	28.90 (1020)	
Refrigeration Cycle	Control Device			Expansion Valve	Expansion Valve	
	Refrigerant Oil		cm <sup>3</sup>	FW50S (270)	FW50S (270)	
	Refrigerant Type		g (oz)	R32, 540 (19.1)	R32, 670 (23.7)	
F-Gas	GWP			675	675	
	CO <sub>2</sub> eq (ton) (Precharged Amount / Maximum Charged Amount)			0.365 / 0.415	0.452 / 0.503	
Dimension	Height (I/D / O/D)		mm (inch)	290 (11-7/16) / 542 (21-11/32)	290 (11-7/16) / 542 (21-11/32)	
	Width (I/D / O/D)		mm (inch)	779 (30-11/16) / 780 (30-23/32)	779 (30-11/16) / 780 (30-23/32)	
	Depth (I/D / O/D)		mm (inch)	209 (8-1/4) / 289 (11-13/32)	209 (8-1/4) / 289 (11-13/32)	
Weight	Net (I/D / O/D)		kg (lb)	8 (18) / 24 (53)	8 (18) / 25 (55)	

Model		Indoor	CS-RZ20WKEW		CS-RZ25WKEW	
		Outdoor	CU-RZ20WKE		CU-RZ25WKE	
Piping	Pipe Diameter (Liquid / Gas)	mm (inch)	6.35 (1/4) / 9.52 (3/8)		6.35 (1/4) / 9.52 (3/8)	
	Standard length	m (ft)	5.0 (16.4)		5.0 (16.4)	
	Length range (min – max)	m (ft)	3 (9.8) ~ 15 (49.2)		3 (9.8) ~ 15 (49.2)	
	I/D & O/D Height different	m (ft)	15.0 (49.2)		15.0 (49.2)	
	Additional Gas Amount	g/m (oz/ft)	10 (0.1)		10 (0.1)	
	Length for Additional Gas	m (ft)	7.5 (24.6)		7.5 (24.6)	
Drain Hose	Inner Diameter	mm	16		16	
	Length	mm	550		550	
Indoor Heat Exchanger	Fin Material		Aluminium (Pre Coat)		Aluminium (Pre Coat)	
	Fin Type		Slit Fin		Slit Fin	
	Row × Stage × FPI		2 × 14 × 17		2 × 15 × 21	
	Size (W × H × L)	mm	580 × 294 × 25.4		580 × 315 × 25.4	
Outdoor Heat Exchanger	Fin Material		Aluminium (Pre Coat)		Aluminium (Pre Coat)	
	Fin Type		Corrugated Fin		Corrugated Fin	
	Row × Stage × FPI		1 × 24 × 17		1 × 24:12 × 17	
	Size (W × H × L)	mm	18.2 × 504 × 710		36.4 × 504:252 × 713:684	
Air Filter	Material		Polypropelene		Polypropelene	
	Type		One-touch		One-touch	
Power Supply			Indoor		Indoor	
Power Supply Cord		A	Nil		Nil	
Thermostat			Electronic Contol		Electronic Contol	
Protection Device			Electronic Contol		Electronic Contol	
			Dry Bulb	Wet Bulb	Dry Bulb	Wet Bulb
Indoor Operation Range	Cooling	Maximum °C	32	23	32	23
		Minimum °C	16	11	16	11
	Heating	Maximum °C	30	–	30	–
		Minimum °C	16	–	16	–
Outdoor Operation Range	Cooling	Maximum °C	43	26	43	26
		Minimum °C	-10	–	-10	–
	Heating	Maximum °C	24	18	24	18
		Minimum °C	-15	-16	-15	-16

- Cooling capacities are based on indoor temperature of 27°C Dry Bulb (80.6°F Dry Bulb), 19.0°C Wet Bulb (66.2°F Wet Bulb) and outdoor air temperature of 35°C DRY BULB (95°F Dry Bulb), 24°C Wet Bulb (75.2°F Wet Bulb)
- Heating capacities are based on indoor temperature of 20°C Dry Bulb (68°F Dry Bulb) and outdoor air temperature of 7°C Dry Bulb (44.6°F Dry Bulb), 6°C Wet Bulb (42.8°F Wet Bulb)
- Heating low temperature capacity, Input Power and COP measured at 230 V, indoor temperature 20°C, outdoor 2/1°C
- Heating extreme low temperature capacity, Input Power and COP measured at 230 V, indoor temperature 20°C, outdoor -7/-8°C
- Standby power consumption ≤2.0W (when switched OFF by remote control, except under self protection control).
- Specifications are subjected to change without prior notice for further improvement.

Model		Indoor	CS-RZ35WKEW			CS-RZ50WKEW				
		Outdoor	CU-RZ35WKE			CU-RZ50WKE				
Performance Test Condition			EUROVENT			EUROVENT				
Power Supply		Phase, Hz	Single, 50			Single, 50				
		V	230			230				
			Min.	Mid.	Max.	Min.	Mid.	Max.		
Cooling	Capacity		kW	0.85	3.50	3.90	0.98	5.00	5.40	
			BTU/h	2900	11900	13300	3340	17100	18400	
			kcal/h	730	3010	3350	840	4300	4640	
	Running Current		A	–	4.40	–	–	7.10	–	
	Input Power		W	235	1.00k	1.19k	250	1.60k	1.80k	
	Annual Consumption		kWh	–	500	–	–	800	–	
	EER		W/W	3.62	3.50	3.28	3.92	3.13	3.00	
			BTU/hW	12.34	11.90	11.18	13.36	10.69	10.22	
			kcal/hW	3.11	3.01	2.82	3.36	2.69	2.58	
	ErP	Pdesign	kW	3.5			5.0			
		SEER	(W/W)	6.2			6.9			
		Annual Consumption	kWh	198			254			
		Class		A++			A++			
	Power Factor		%	–	99	–	–	98	–	
	Indoor Noise (H / L / QLo)		dB-A	42 / 30 / 20			44 / 37 / 33			
			Power Level dB	58 / – / –			60 / – / –			
	Outdoor Noise (H / L)		dB-A	48 / –			48 / –			
			Power Level dB	63 / –			63 / –			
	Heating	Capacity		kW	0.80	4.00	5.10	0.98	5.80	7.50
				BTU/h	2730	13600	17400	3340	19800	25600
kcal/h				690	3440	4390	840	4990	6450	
Running Current		A	–	4.60	–	–	7.60	–		
Input Power		W	195	1.05k	1.42k	210	1.70k	2.30k		
COP		W/W	4.10	3.81	3.59	4.67	3.41	3.26		
		BTU/hW	14.00	12.95	12.25	15.90	11.65	11.13		
		kcal/hW	3.54	3.28	3.09	4.00	2.94	2.80		
ErP		Pdesign	kW	2.8			4.0			
		Tbivalent	°C	-10			-10			
		SCOP	(W/W)	4.6			4.4			
		Annual Consumption	kWh	852			1273			
		Class		A++			A+			
Power Factor		%	–	99	–	–	97	–		
Indoor Noise (H / L / QLo)		dB-A	42 / 33 / 22			44 / 37 / 33				
		Power Level dB	58 / – / –			60 / – / –				
Outdoor Noise (H / L)		dB-A	50 / –			49 / –				
		Power Level dB	65 / –			64 / –				
Low Temp. : Capacity (kW) / I.Power (W) / COP			3.70 / 1.26k / 2.94			5.43 / 2.04k / 2.66				
Extr Low Temp. : Capacity (kW) / I.Power (W) / COP			3.30 / 1.35k / 2.44			4.62 / 2.00k / 2.31				
Max Current (A) / Max Input Power (W)			6.3 / 1.42k			10.5 / 2.30k				
Starting Current (A)			4.60			7.60				

Model			Indoor	CS-RZ35WKEW	CS-RZ50WKEW	
			Outdoor	CU-RZ35WKE	CU-RZ50WKE	
Compressor	Type			Hermetic Motor (Rotary)	Hermetic Motor (Rotary)	
	Motor Type			Brushless (6 poles)	Brushless (4 poles)	
	Output Power		W	700	900	
Indoor Fan	Type			Cross-Flow Fan	Cross-Flow Fan	
	Material			ASG30	ASG30	
	Motor Type			DC / Transistor (8-poles)	DC / Transistor (8-poles)	
	Input Power		W	43.8	43.8	
	Output Power		W	40	40	
	Speed	QLo	Cool	rpm	640	930
			Heat	rpm	660	970
		Lo	Cool	rpm	850	1040
			Heat	rpm	970	1090
		Me	Cool	rpm	1030	1160
			Heat	rpm	1110	1210
		Hi	Cool	rpm	1210	1280
			Heat	rpm	1260	1340
	SHi	Cool	rpm	1260	1330	
		Heat	rpm	1310	1420	
Outdoor Fan	Type			Propeller Fan	Propeller Fan	
	Material			PP	PP	
	Motor Type			DC (8-poles)	DC (8-poles)	
	Input Power		W	-	-	
	Output Power		W	40	40	
	Speed	Hi	Cool	rpm	830	820
Heat			rpm	860	820	
Moisture Removal			L/h (Pt/h)	2.0 (4.2)	2.8 (5.9)	
Indoor Airflow	QLo	Cool	m <sup>3</sup> /min (ft <sup>3</sup> /min)	5.73 (202)	8.80 (310)	
		Heat	m <sup>3</sup> /min (ft <sup>3</sup> /min)	5.94 (209)	9.22 (324)	
	Lo	Cool	m <sup>3</sup> /min (ft <sup>3</sup> /min)	7.95 (280)	9.97 (352)	
		Heat	m <sup>3</sup> /min (ft <sup>3</sup> /min)	9.22 (325)	10.50 (370)	
	Me	Cool	m <sup>3</sup> /min (ft <sup>3</sup> /min)	9.86 (348)	11.24 (396)	
		Heat	m <sup>3</sup> /min (ft <sup>3</sup> /min)	10.71 (378)	11.77 (415)	
	Hi	Cool	m <sup>3</sup> /min (ft <sup>3</sup> /min)	11.80 (415)	12.50 (440)	
		Heat	m <sup>3</sup> /min (ft <sup>3</sup> /min)	12.30 (435)	13.20 (465)	
SHi	Cool	m <sup>3</sup> /min (ft <sup>3</sup> /min)	12.30 (435)	13.04 (460)		
	Heat	m <sup>3</sup> /min (ft <sup>3</sup> /min)	12.83 (453)	13.99 (494)		
Outdoor Airflow	Hi	Cool	m <sup>3</sup> /min (ft <sup>3</sup> /min)	28.70 (1015)	32.70 (1155)	
		Heat	m <sup>3</sup> /min (ft <sup>3</sup> /min)	29.70 (1050)	32.70 (1155)	
Refrigeration Cycle	Control Device			Expansion Valve	Expansion Valve	
	Refrigerant Oil		cm <sup>3</sup>	FW50S (320)	FW50S (450)	
	Refrigerant Type		g (oz)	R32, 770 (27.2)	R32, 1.14k (40.2)	
F-Gas	GWP			675	675	
	CO2eq (ton) (Precharged Amount / Maximum Charged Amount)			0.520 / 0.570	0.770 / 0.896	
Dimension	Height (I/D / O/D)		mm (inch)	290 (11-7/16) / 542 (21-11/32)	290 (11-7/16) / 619 (24-3/8)	
	Width (I/D / O/D)		mm (inch)	779 (30-11/16) / 780 (30-23/32)	779 (30-11/16) / 824 (32-15/32)	
	Depth (I/D / O/D)		mm (inch)	209 (8-1/4) / 289 (11-13/32)	209 (8-1/4) / 299 (11-25/32)	
Weight	Net (I/D / O/D)		kg (lb)	8 (18) / 31 (68)	8 (18) / 36 (79)	

Model		Indoor	CS-RZ35WKEW		CS-RZ50WKEW	
		Outdoor	CU-RZ35WKE		CU-RZ50WKE	
Piping	Pipe Diameter (Liquid / Gas)	mm (inch)	6.35 (1/4) / 9.52 (3/8)		6.35 (1/4) / 12.70 (1/2)	
	Standard length	m (ft)	5.0 (16.4)		5.0 (16.4)	
	Length range (min – max)	m (ft)	3 (9.8) ~ 15 (49.2)		3 (9.8) ~ 20 (65.6)	
	I/D & O/D Height different	m (ft)	15.0 (49.2)		15.0 (49.2)	
	Additional Gas Amount	g/m (oz/ft)	10 (0.1)		15 (0.2)	
	Length for Additional Gas	m (ft)	7.5 (24.6)		7.5 (24.6)	
Drain Hose	Inner Diameter	mm	16		16	
	Length	mm	550		550	
Indoor Heat Exchanger	Fin Material		Aluminium (Pre Coat)		Aluminium (Pre Coat)	
	Fin Type		Slit Fin		Slit Fin	
	Row × Stage × FPI		2 × 15 × 21		2 × 15 × 21	
	Size (W × H × L)	mm	580 × 315 × 25.4		580 × 315 × 25.4	
Outdoor Heat Exchanger	Fin Material		Aluminium (Pre Coat)		Aluminium (Pre Coat)	
	Fin Type		Corrugated Fin		Corrugated Fin	
	Row × Stage × FPI		2 × 24 × 17		2 × 28 × 17	
	Size (W × H × L)	mm	36.4 × 504 × 713:684		36.38 × 588 × 856.3:827.7	
Air Filter	Material		Polypropelene		Polypropelene	
	Type		One-touch		One-touch	
Power Supply			Indoor		Indoor	
Power Supply Cord		A	Nil		Nil	
Thermostat			Electronic Contol		Electronic Contol	
Protection Device			Electronic Contol		Electronic Contol	
			Dry Bulb	Wet Bulb	Dry Bulb	Wet Bulb
Indoor Operation Range	Cooling	Maximum °C	32	23	32	23
		Minimum °C	16	11	16	11
	Heating	Maximum °C	30	–	30	–
		Minimum °C	16	–	16	–
Outdoor Operation Range	Cooling	Maximum °C	43	26	43	26
		Minimum °C	-10	–	-10	–
	Heating	Maximum °C	24	18	24	18
		Minimum °C	-15	-16	-15	-16

- Cooling capacities are based on indoor temperature of 27°C Dry Bulb (80.6°F Dry Bulb), 19.0°C Wet Bulb (66.2°F Wet Bulb) and outdoor air temperature of 35°C DRY BULB (95°F Dry Bulb), 24°C Wet Bulb (75.2°F Wet Bulb)
- Heating capacities are based on indoor temperature of 20°C Dry Bulb (68°F Dry Bulb) and outdoor air temperature of 7°C Dry Bulb (44.6°F Dry Bulb), 6°C Wet Bulb (42.8°F Wet Bulb)
- Heating low temperature capacity, Input Power and COP measured at 230 V, indoor temperature 20°C, outdoor 2/1°C
- Heating extreme low temperature capacity, Input Power and COP measured at 230 V, indoor temperature 20°C, outdoor -7/-8°C
- Standby power consumption ≤2.0W (when switched OFF by remote control, except under self protection control).
- Specifications are subjected to change without prior notice for further improvement.

• **Multi Split Combination Possibility:**

- A single outdoor unit enables air conditioning of up to two separate rooms for CU-2Z35TBE, CU-2Z41TBE, CU-2Z50TBE.
- A single outdoor unit enables air conditioning of up to three separate rooms for CU-3Z68TBE, CU-3Z52TBE.

CONNECTABLE INDOOR UNIT			OUTDOOR UNIT											
			CU-2Z35TBE		CU-2Z41TBE		CU-2Z50TBE		CU-3Z68TBE			CU-3Z52TBE		
ROOM			A	B	A	B	A	B	A	B	C	A	B	C
TYPE														
Wall	1.6kW	CS-MTZ16WKE	•	•	•	•	•	•	•	•	•	•	•	•
	2.0kW	CS-TZ20WKEW CS-RZ20WKEW	•	•	•	•	•	•	•	•	•	•	•	•
	2.5kW	CS-TZ25WKEW CS-RZ25WKEW	•	•	•	•	•	•	•	•	•	•	•	•
	3.5kW	CS-TZ35WKEW CS-RZ35WKEW	•	-	•	-	•	•	•	•	•	•	•	-
	4.2kW	CS-TZ42WKEW	-	-	-	-	•	-	•	•	-	•	•	-
	5.0kW	CS-TZ50WKEW CS-RZ50WKEW	-	-	-	-	•	-	•	•	-	•	-	-
	6.0kW	CS-TZ60WKEW	-	-	-	-	-	-	•	-	-	-	-	-
Capacity range of connectable units			From 3.2kW to 6.0kW		From 3.2kW to 6.0kW		From 3.2kW to 7.7kW		From 4.5kW to 11.2kW			From 4.5kW to 9.5kW		
Pipe length	1 room maximum pipe length (m)		20		20		20		25			25		
	Allowable elevation (m)		10		10		10		15			15		
	Total allowable pipe length (m)		30		30		30		60			50		
	Total pipe length for maximum chargeless length (m)		20		20		20		30			30		
	Additional gas amount over chargeless length (g/m)		15		15		15		20			20		
Note: "•" : Available														
<b>Remarks for CU-2Z35TBE / CU-2Z41TBE / CU-2Z50TBE</b>														
1. At least two indoor units must be connected. 2. The total nominal cooling capacity of indoor unit that will be connected to outdoor unit must be within connectable capacity range of indoor unit. (as shown in the table above) Example: The indoor units' combination below is possible to connect to CU-2Z41TBE. (Total nominal capacity of indoor units is between 3.2kW to 6.0kW) 1) Two CS-TZ20WKEW only. (Total nominal cooling capacity is 4.0kW)														
<b>Remarks for CU-3Z68TBE / CU-3Z52TBE</b>														
1. At least two indoor units must be connected. 2. The total nominal cooling capacity of indoor unit that will be connected to outdoor unit must be within connectable capacity range of indoor unit. (as shown in the table above) Example: The indoor units' combination below is possible to connect to CU-3Z68TBE. (Total nominal capacity of indoor units is between 4.5kW to 11.2kW) 1) Two CS-TZ25WKEW only. (Total nominal cooling capacity is 5.0kW)														

• **Multi Split Combination Possibility:**

- A single outdoor unit enables air conditioning of up to four separate rooms for CU-4Z68TBE, CU-4Z80TBE.
- A single outdoor unit enables air conditioning of up to five separate rooms for CU-5Z90TBE.

CONNECTABLE INDOOR UNIT			OUTDOOR UNIT												
			CU-4Z68TBE				CU-4Z80TBE				CU-5Z90TBE				
TYPE	ROOM		A	B	C	D	A	B	C	D	A	B	C	D	E
	Wall	1.6kW	CS-MTZ16WKE	•	•	•	•	•	•	•	•	•	•	•	•
2.0kW		CS-TZ20WKEW CS-RZ20WKEW	•	•	•	•	•	•	•	•	•	•	•	•	•
2.5kW		CS-TZ25WKEW CS-RZ25WKEW	•	•	•	•	•	•	•	•	•	•	•	•	•
3.5kW		CS-TZ35WKEW CS-RZ35WKEW	•	•	•	-	•	•	•	•	•	•	•	•	•
4.2kW		CS-TZ42WKEW	•	•	-	-	•	•	•	-	•	•	•	•	-
5.0kW		CS-TZ50WKEW CS-RZ50WKEW	•	•	-	-	•	•	-	-	•	•	•	-	-
6.0kW		CS-TZ60WKEW	•	-	-	-	•	•	-	-	•	•	•	-	-
7.1kW		CS-TZ71WKEW	-	-	-	-	•	•	-	-	•	•	-	-	-
Capacity range of connectable units			From 4.5kW to 11.5kW				From 4.5kW to 14.7kW				From 4.5kW to 18.3kW				
Pipe length	1 room maximum pipe length (m)		25				25				25				
	Allowable elevation (m)		15				15				15				
	Total allowable pipe length (m)		60				70				80				
	Total pipe length for maximum chargeless length (m)		30				45				45				
	Additional gas amount over chargeless length (g/m)		20				20				20				
Note: "•" : Available															
<p><b>Remarks for CU-4Z68TBE / CU-4Z80TBE / CU-5Z90TBE</b></p> <p>1. At least two indoor units must be connected.</p> <p>2. The total nominal cooling capacity of indoor unit that will be connected to outdoor unit must be within connectable capacity range of indoor unit. (as shown in the table above)            Example: The indoor units' combination below is possible to connect to CU-4Z80TBE. (Total nominal capacity of indoor units is between 4.5kW to 14.7kW)            1) Two CS-TZ25WKEW only. (Total nominal cooling capacity is 5.0kW)</p>															

• **Multi Split Combination Possibility:**

- A single outdoor unit enables air conditioning of up to two separate rooms for CU-2TZ41TBE, CU-2TZ50TBE.
- A single outdoor unit enables air conditioning of up to three separate rooms for CU-3TZ52TBE.

CONNECTABLE INDOOR UNIT			OUTDOOR UNIT						
			CU-2TZ41TBE		CU-2TZ50TBE		CU-3TZ52TBE		
ROOM			A	B	A	B	A	B	C
TYPE			A	B	A	B	A	B	C
Wall	1.6kW	CS-MTZ16WKE	•	•	•	•	•	•	•
	2.0kW	CS-TZ20WKEW CS-RZ20WKEW	•	•	•	•	•	•	•
	2.5kW	CS-TZ25WKEW CS-RZ25WKEW	•	•	•	•	•	•	•
	3.5kW	CS-TZ35WKEW CS-RZ35WKEW	•	–	•	•	•	•	–
	4.2kW	CS-TZ42WKEW	–	–	•	–	•	•	–
	5.0kW	CS-TZ50WKEW CS-RZ50WKEW	–	–	•	–	•	–	–
Capacity range of connectable units			From 3.2kW to 6.0kW		From 3.2kW to 7.7kW		From 4.5kW to 9.5kW		
Pipe length	1 room maximum pipe length (m)		20		20		25		
	Allowable elevation (m)		10		10		15		
	Total allowable pipe length (m)		30		30		50		
	Total pipe length for maximum chargeless length (m)		20		20		30		
	Additional gas amount over chargeless length (g/m)		15		15		20		
Note: “•”: Available									
<p><b>Remarks for CU-2TZ41TBE / CU-2TZ50TBE / CU-3TZ52TBE</b></p> <p>1. At least two indoor units must be connected.</p> <p>2. The total nominal cooling capacity of indoor unit that will be connected to outdoor unit must be within connectable capacity range of indoor unit. (as shown in the table above)</p> <p>Example: The indoor units' combination below is possible to connect to CU-3TZ52TBE. (Total nominal capacity of indoor units is between 4.5kW to 9.5kW)</p> <p>1) Two CS-TZ25WKEW only. (Total nominal cooling capacity is 5.0kW)</p>									

## 4. Features

- **Inverter Technology**
  - Wider output power range
  - Energy saving
  - Quick Cooling
  - Quick Heating
  - More precise temperature control
- **Environment Protection**
  - Non-ozone depletion substances refrigerant (R32)
- **Long Installation Piping**
  - Long piping up to 15 meters (3/4 ~ 1.75HP), 20 meters (2.0HP) and 30 meters (2.25 ~ 2.5HP) during single split connection only
- **Easy to use remote control**
- **Quality Improvement**
  - Random auto restart after power failure for safety restart operation
  - Gas leakage protection
  - Prevent compressor reverse cycle
  - Inner protector to protect compressor
  - Noise prevention during soft dry operation
- **Operation Improvement**
  - Quiet mode to reduce the indoor unit operating sound
  - Powerful mode to reach the desired room temperature quickly
  - 24-hour timer setting
- **Serviceability Feature**
  - Activation and Deactivation Method for Heating Only Mode
  - Breakdown Self Diagnosis function

## 5. Location of Controls and Components

### 5.1 Indoor Unit

#### 5.1.1 CS-TZ20WKEW CS-TZ25WKEW CS-TZ35WKEW CS-TZ42WKEW CS-TZ50WKEW CS-RZ20WKEW CS-RZ25WKEW CS-RZ35WKEW CS-RZ50WKEW

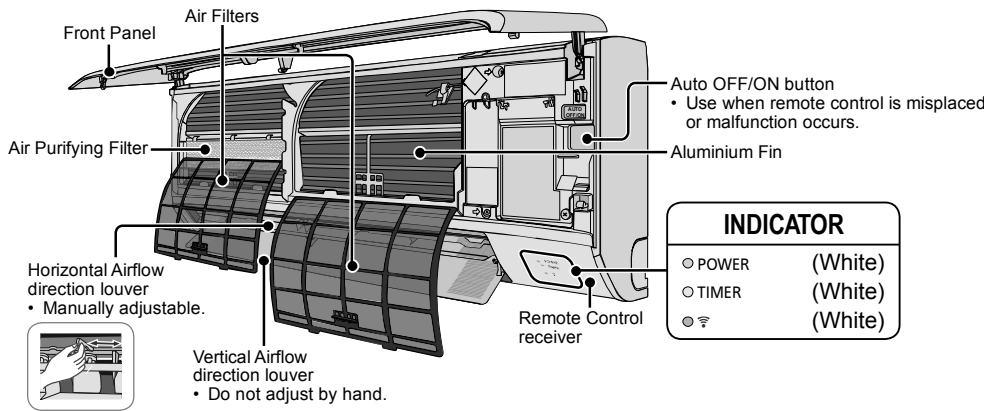

#### 5.1.2 CS-TZ60WKEW CS-TZ71WKEW

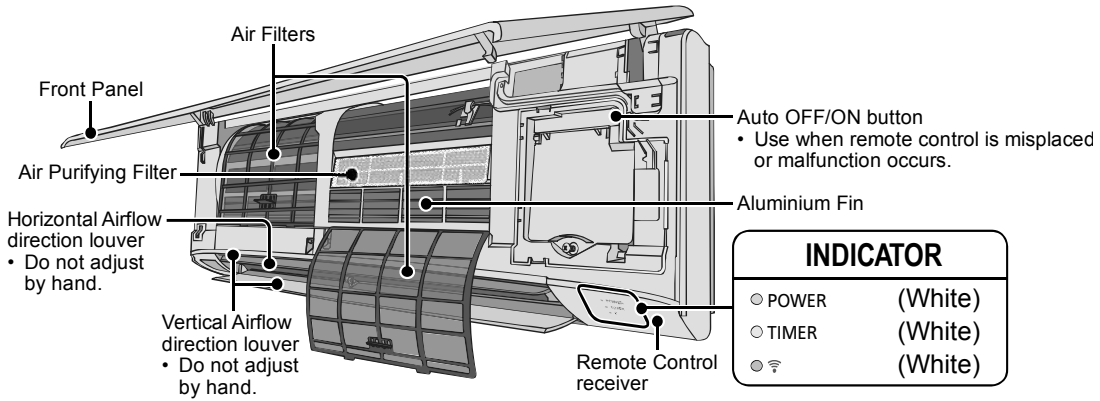

### 5.2 Outdoor Unit

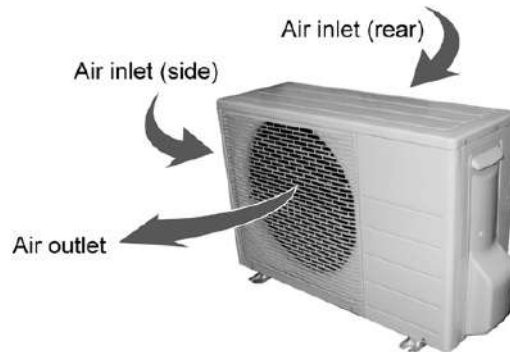

## 5.3 Remote Control

### 5.3.1 CS-TZ20WKEW CS-TZ25WKEW CS-TZ35WKEW CS-TZ42WKEW CS-TZ50WKEW CS-RZ20WKEW CS-RZ25WKEW CS-RZ35WKEW CS-RZ50WKEW

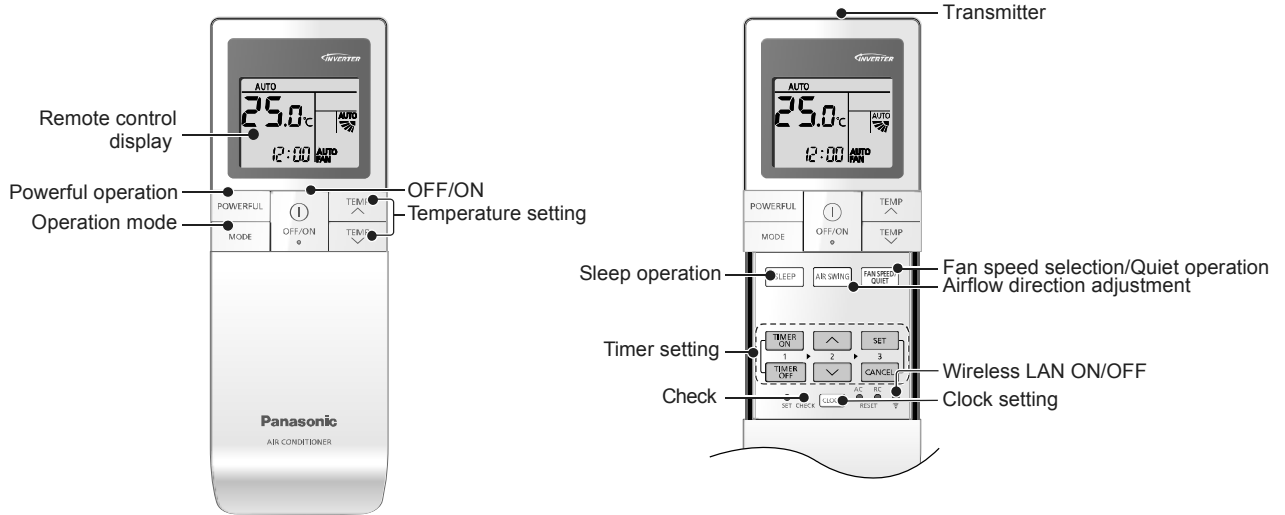

### 5.3.2 CS-TZ60WKEW CS-TZ71WKEW

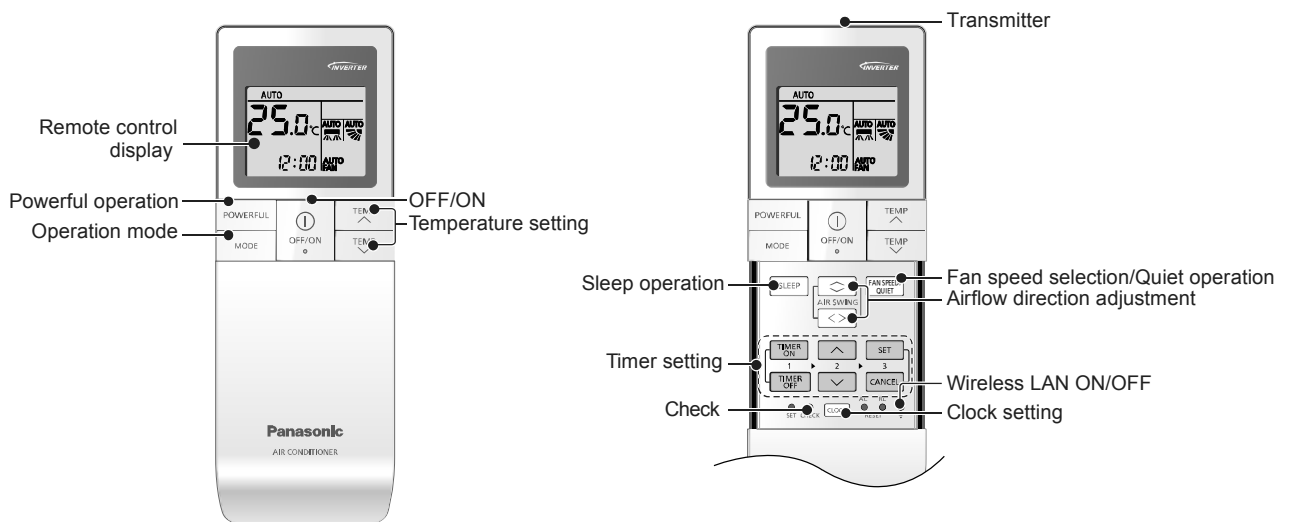

# 6. Dimensions

## 6.1 Indoor Unit

### 6.1.1 CS-TZ20WKEW CS-TZ25WKEW CS-TZ35WKEW CS-TZ42WKEW CS-TZ50WKEW CS-RZ20WKEW CS-RZ25WKEW CS-RZ35WKEW CS-RZ50WKEW

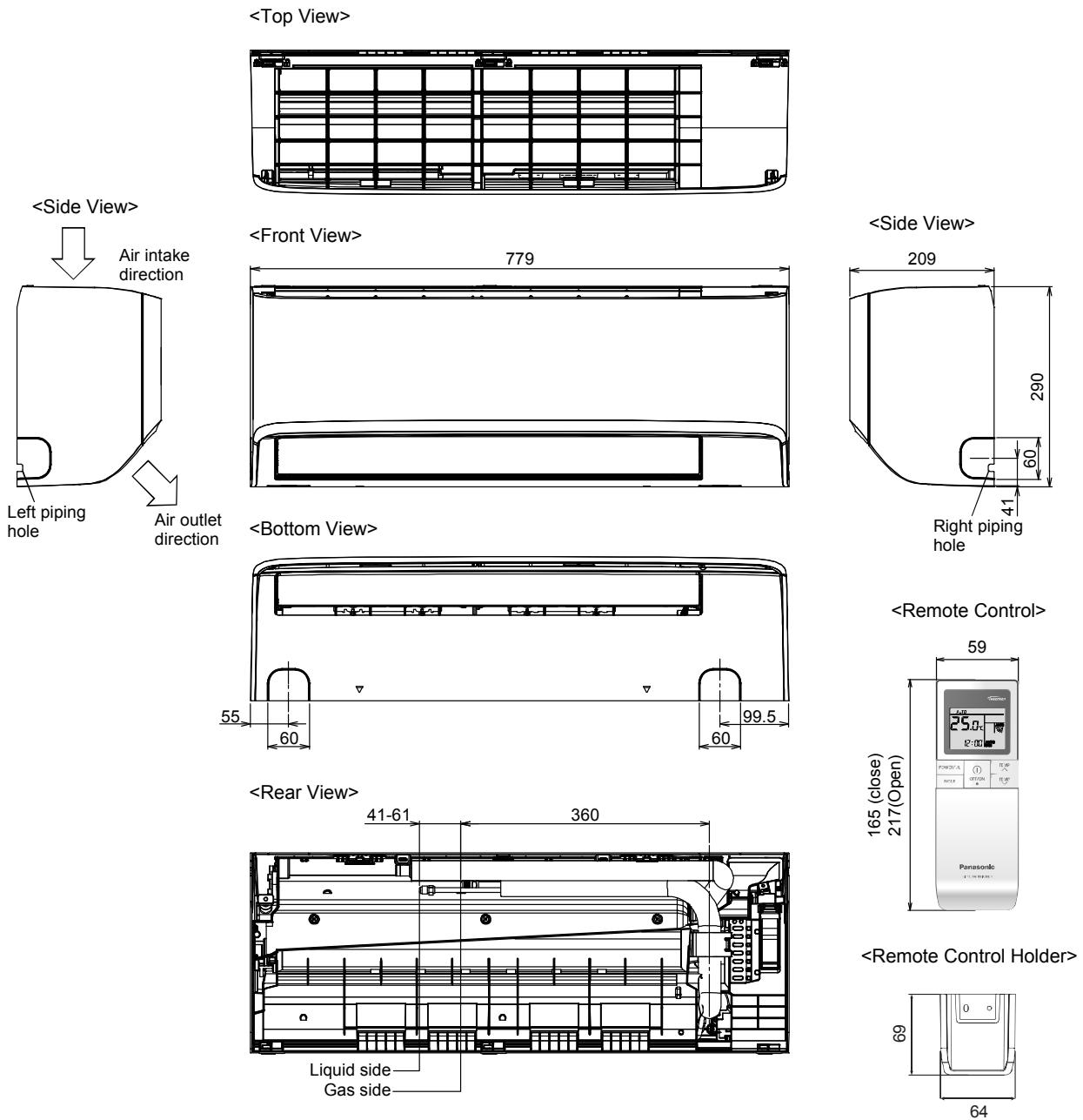

Relative position between the indoor unit and the installation plate <Front View>

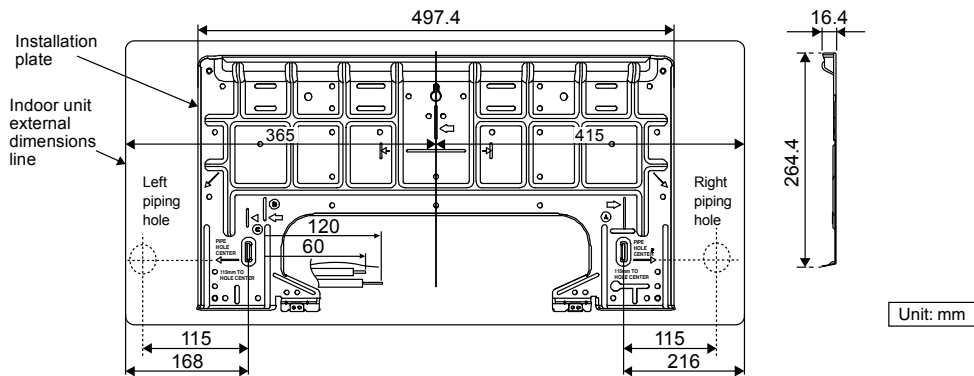

## 6.1.2 CS-TZ60WKEW CS-TZ71WKEW

<Top View>

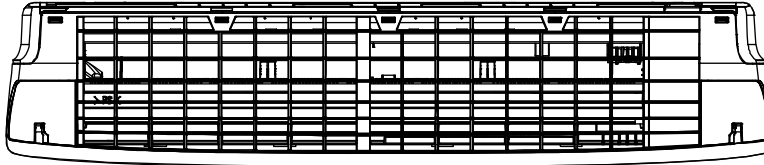

<Side View>

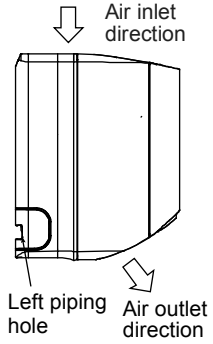

<Front View>

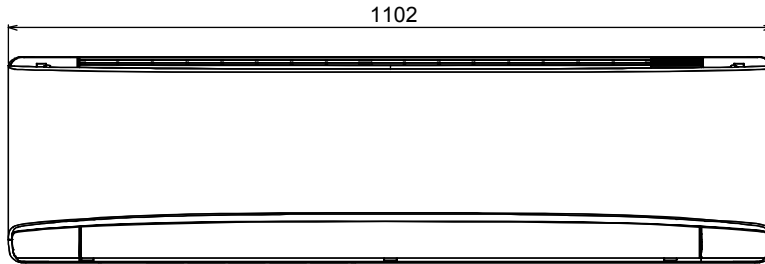

<Side View>

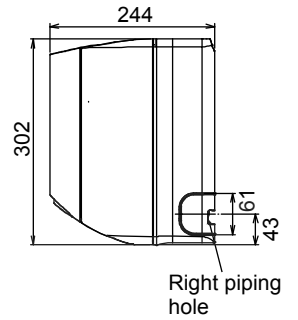

<Bottom View>

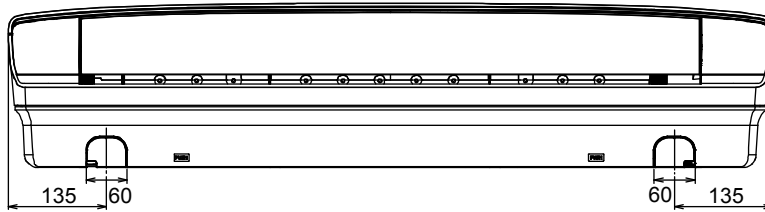

<Remote Control>



<Rear View>

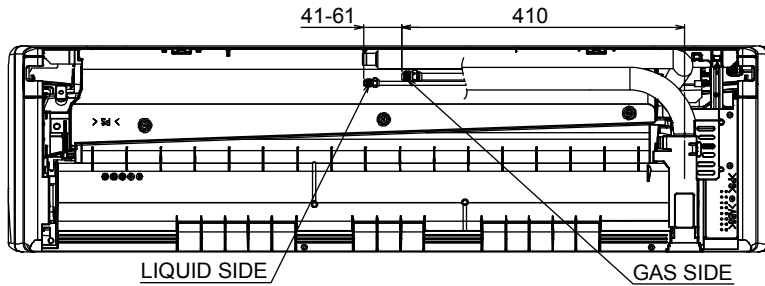

<Remote Control Holder>

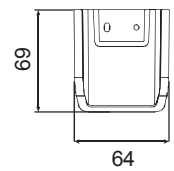

Relative position between the indoor unit and the installation plate <Front View>

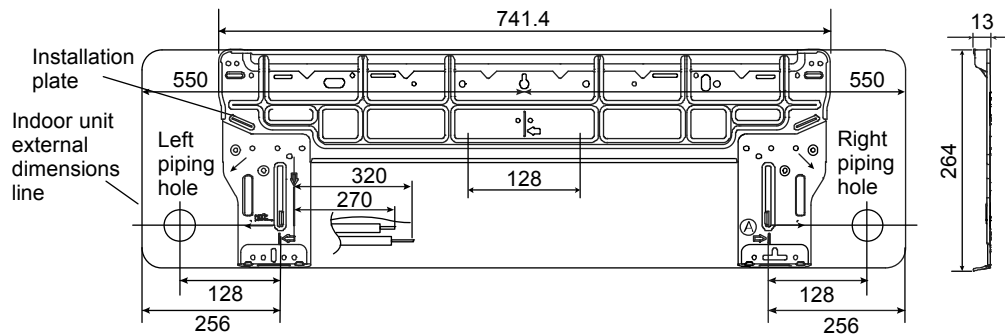

Unit: mm

## 6.2 Outdoor Unit

### 6.2.1 CU-TZ20WKE CU-TZ25WKE CU-TZ35WKE CU-TZ42WKE CU-RZ20WKE CU-RZ25WKE CU-RZ35WKE

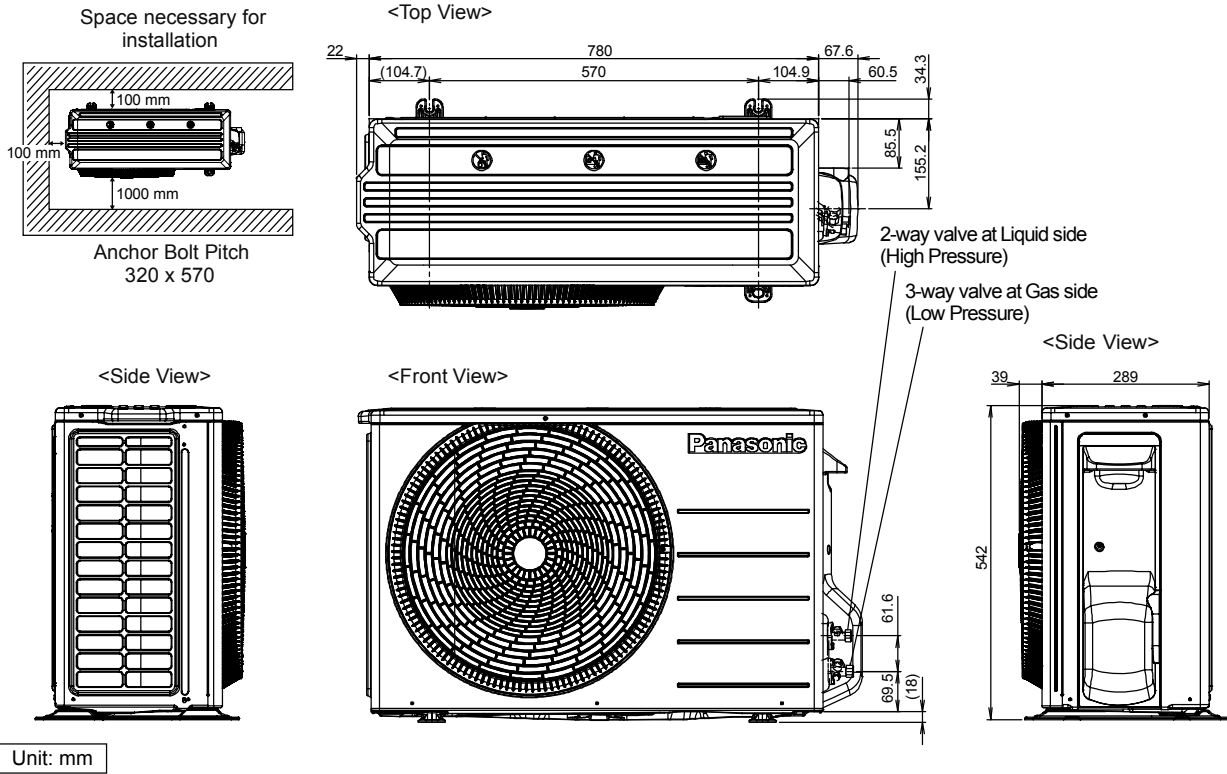

### 6.2.2 CU-TZ50WKE CU-TZ60WKE CU-RZ50WKE

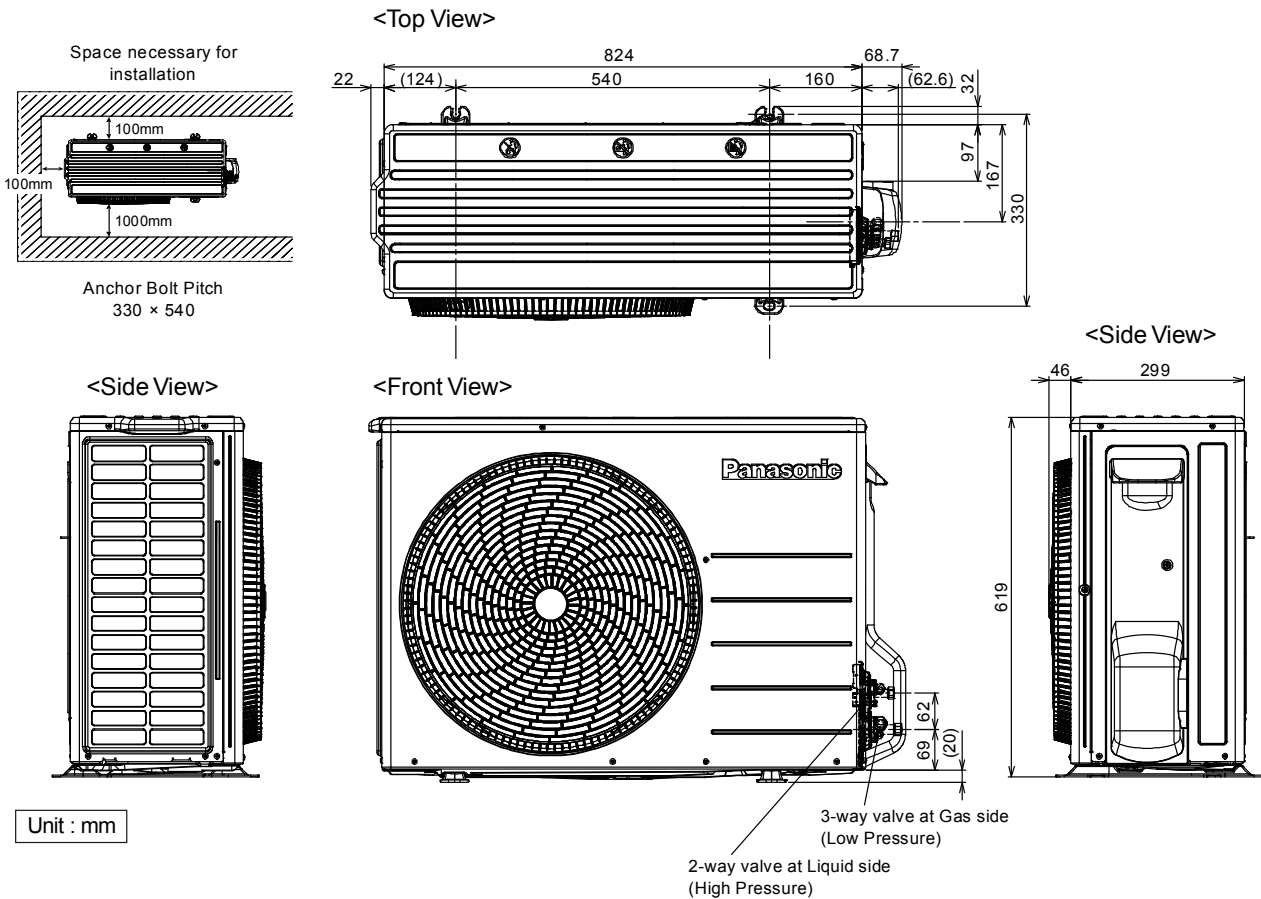

### 6.2.3 CU-TZ71WKE

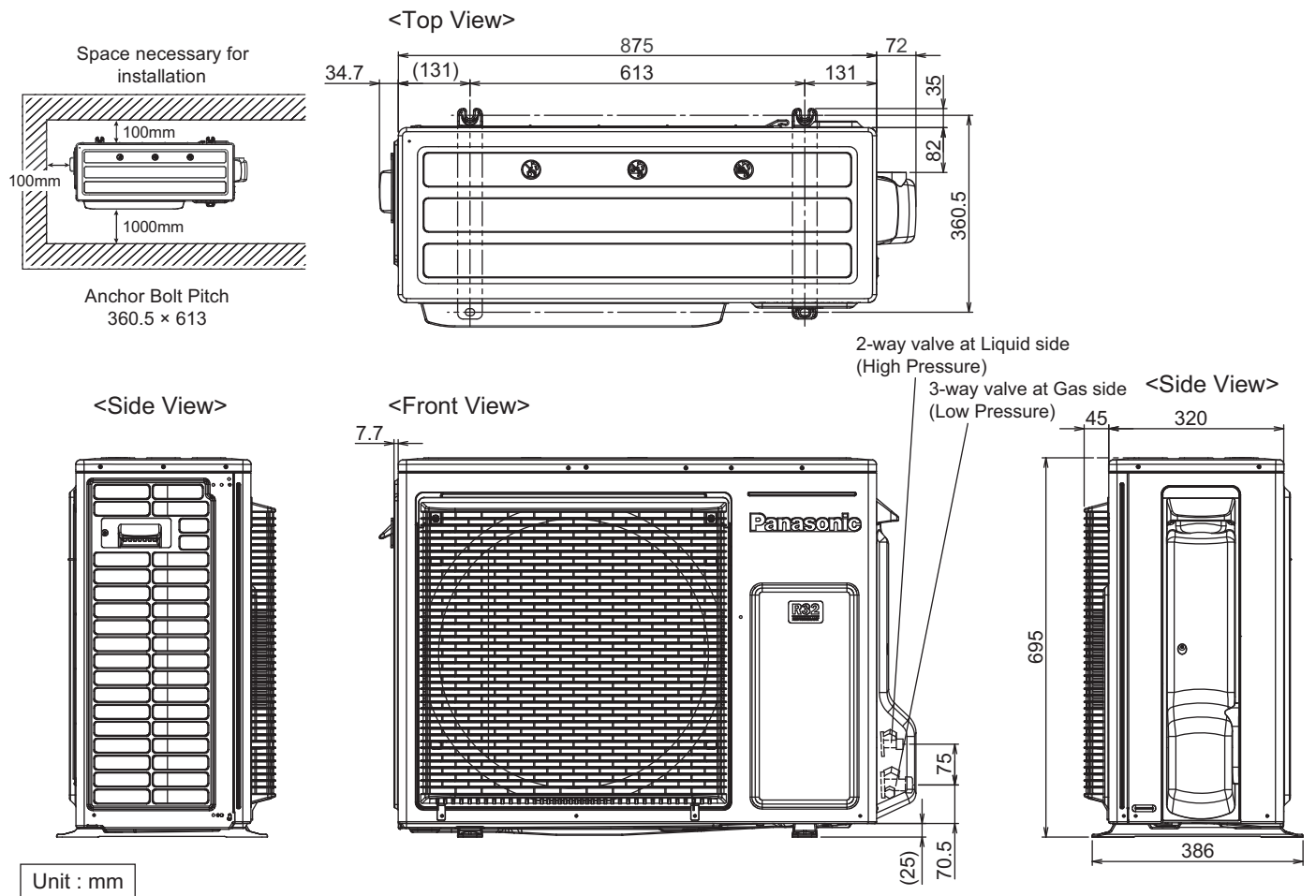

# 7. Refrigeration Cycle Diagram

**7.1 CS-TZ20WKEW CU-TZ20WKE CS-TZ25WKEW CU-TZ25WKE  
 CS-TZ35WKEW CU-TZ35WKE CS-TZ42WKEW CU-TZ42WKE  
 CS-RZ20WKEW CU-RZ20WKE CS-RZ25WKEW CU-RZ25WKE  
 CS-RZ35WKEW CU-RZ35WKE**

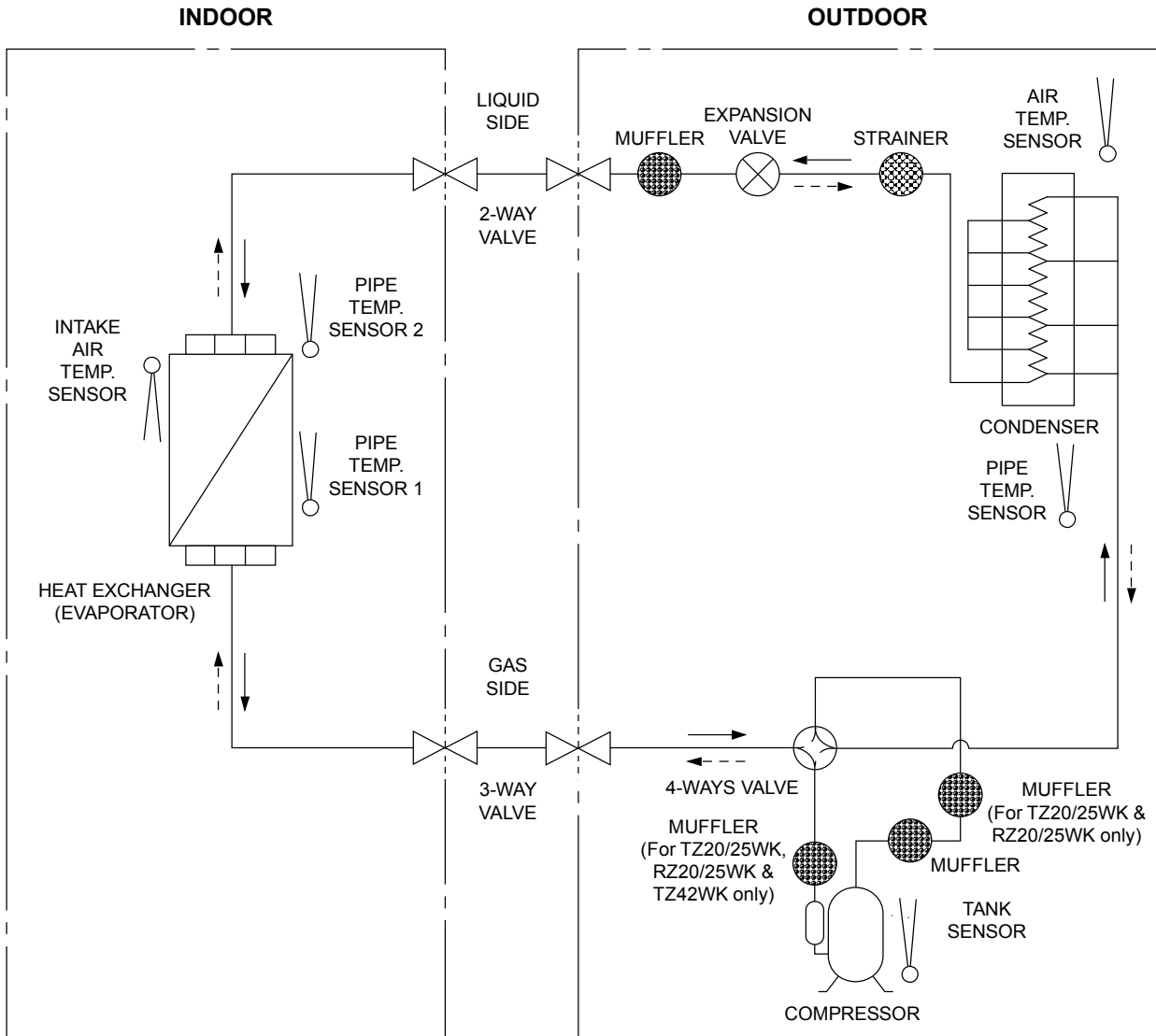

—▶ COOLING  
 - - -▶ HEATING

**7.2 CS-TZ50WKEW CU-TZ50WKE CS-TZ60WKEW CU-TZ60WKE  
CS-RZ50WKEW CU-RZ50WKE**

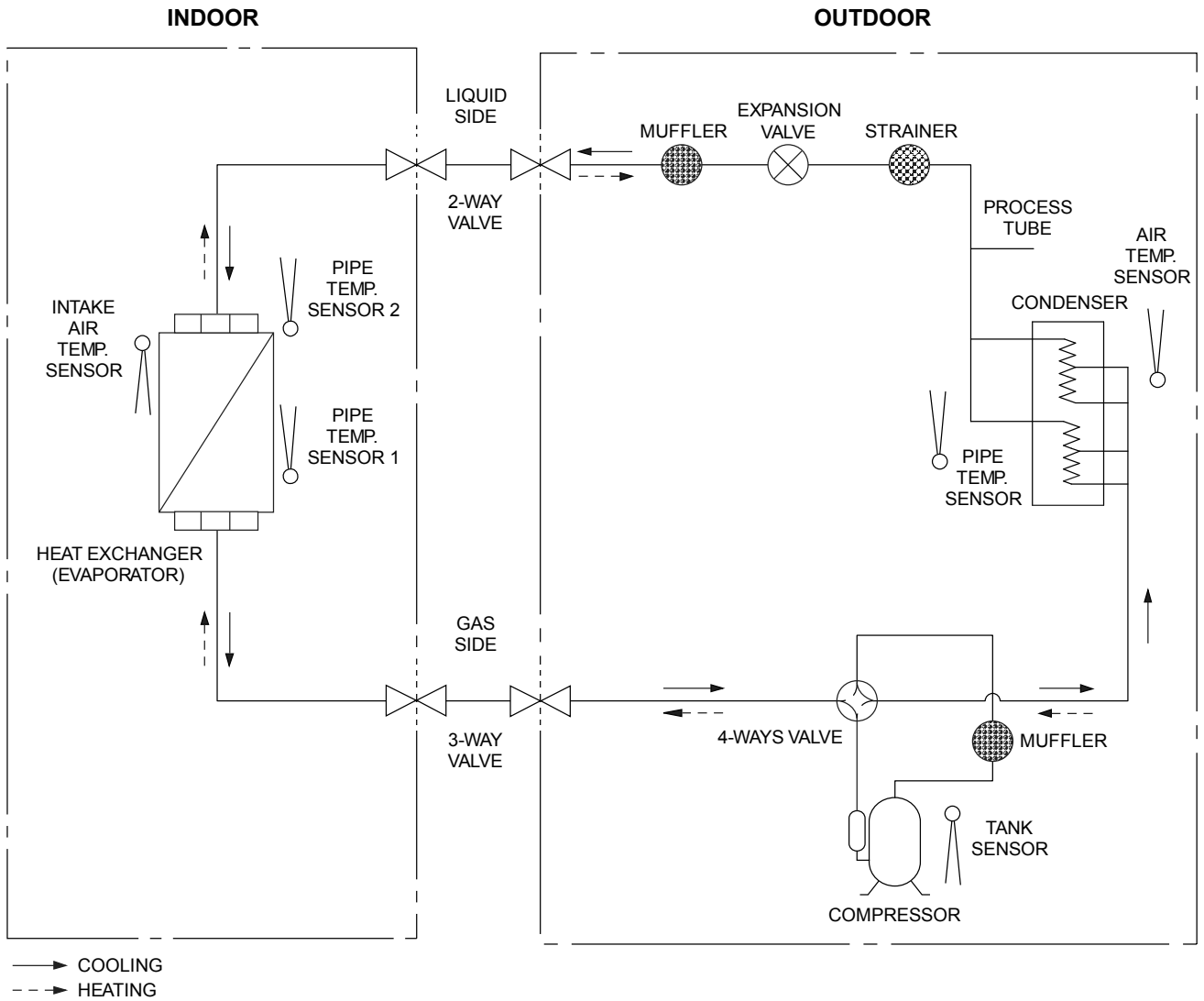

### 7.3 CS-TZ71WKEW CU-TZ71WKE

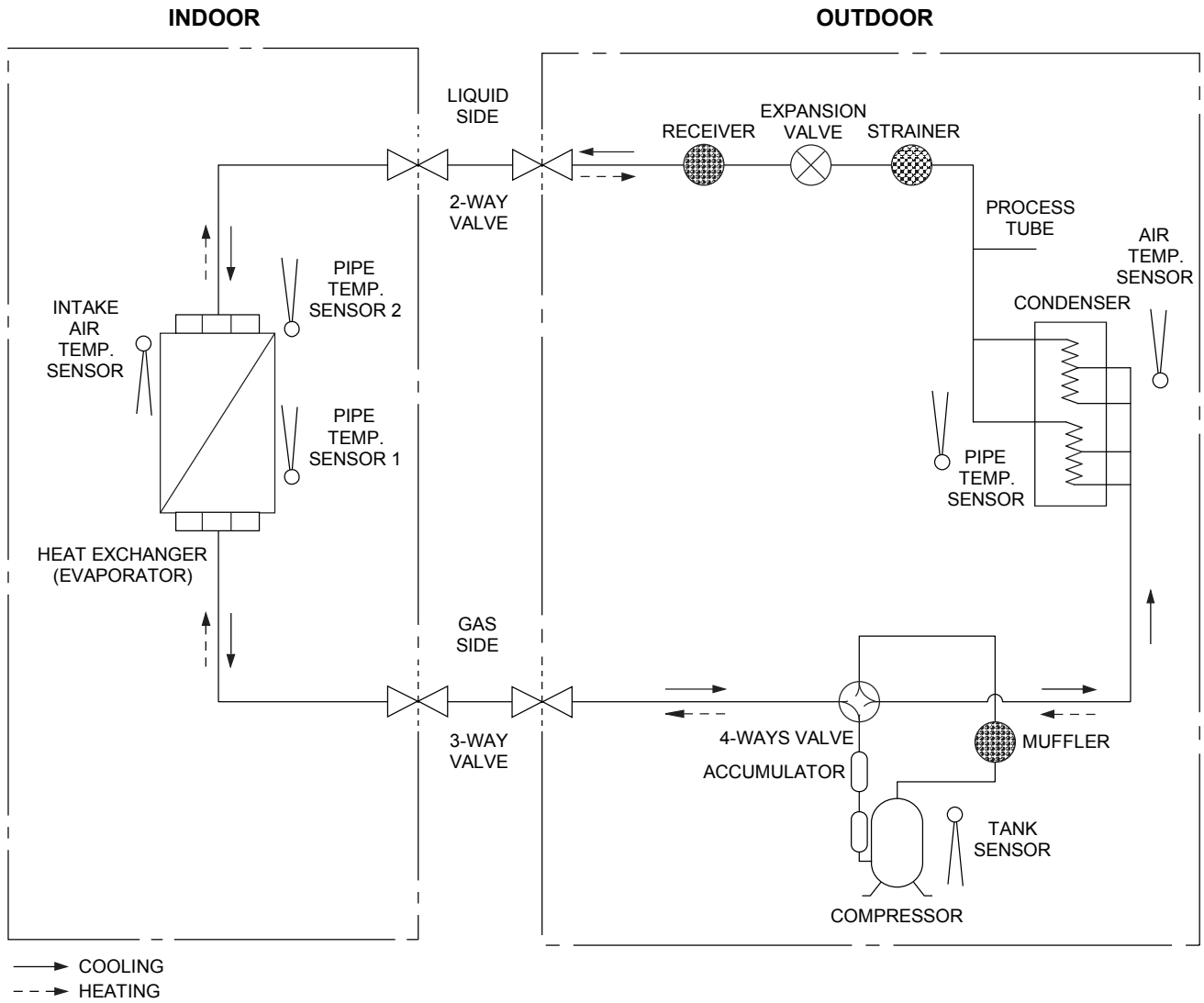

# 8. Block Diagram

## 8.1 Indoor Unit

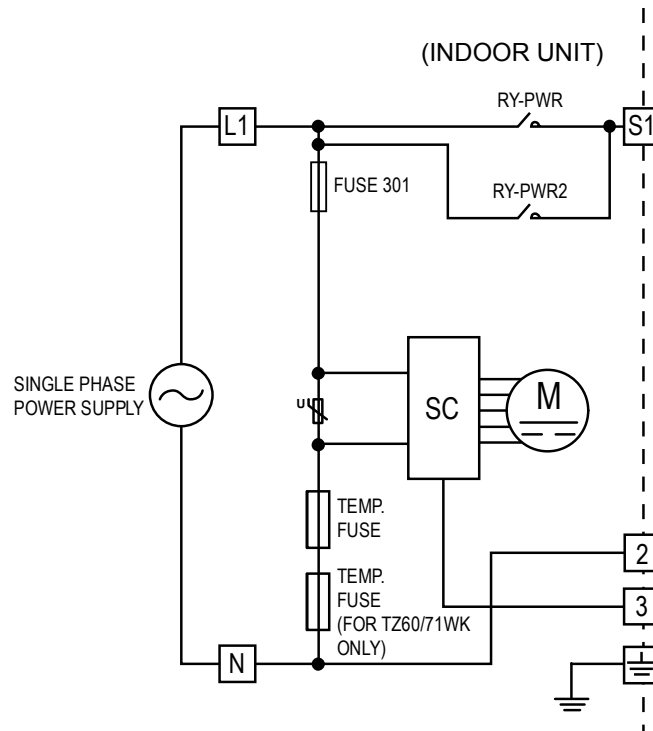

## 8.2 Outdoor Unit

### 8.2.1 CU-TZ20WKE CU-TZ25WKE CU-TZ35WKE CU-TZ42WKE CU-RZ20WKE CU-RZ25WKE CU-RZ35WKE

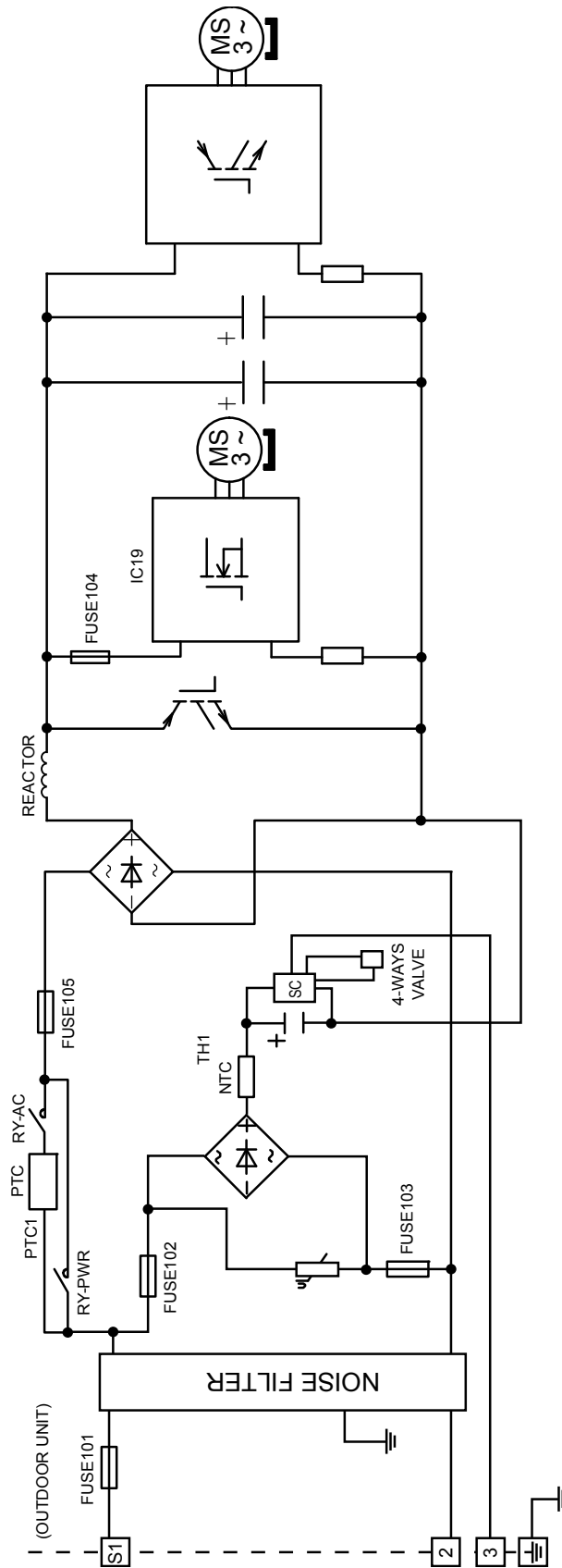

8.2.2 CU-TZ50WKE CU-TZ60WKE CU-TZ71WKE CU-RZ50WKE

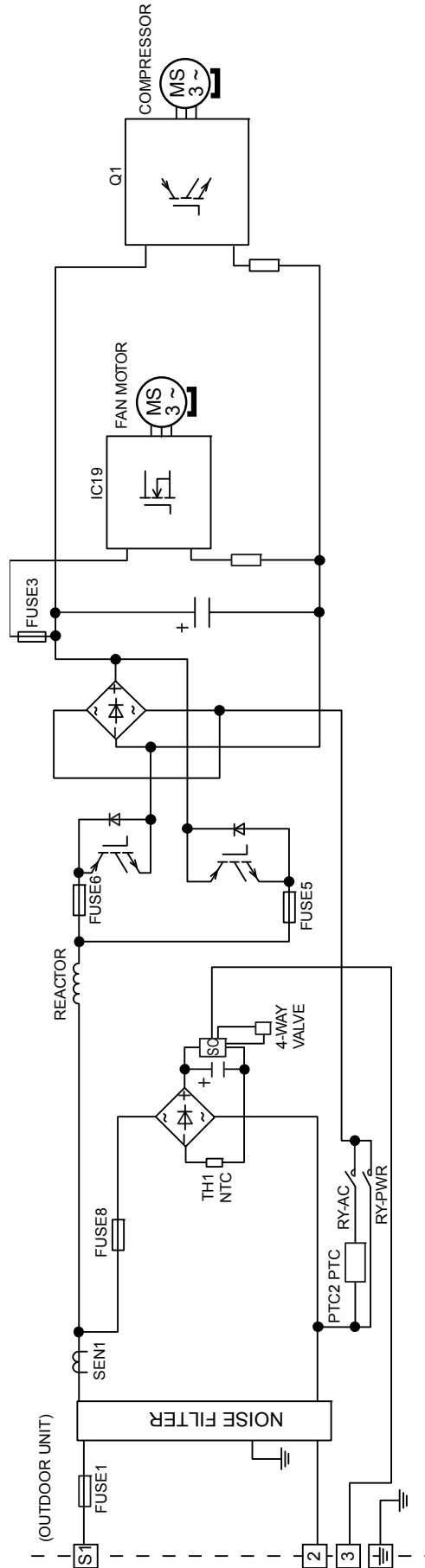

# 9. Wiring Connection Diagram

## 9.1 Indoor Unit

### 9.1.1 CS-TZ20WKEW CS-TZ25WKEW CS-TZ35WKEW CS-TZ42WKEW CS-TZ50WKEW CS-RZ20WKEW CS-RZ25WKEW CS-RZ35WKEW CS-RZ50WKEW

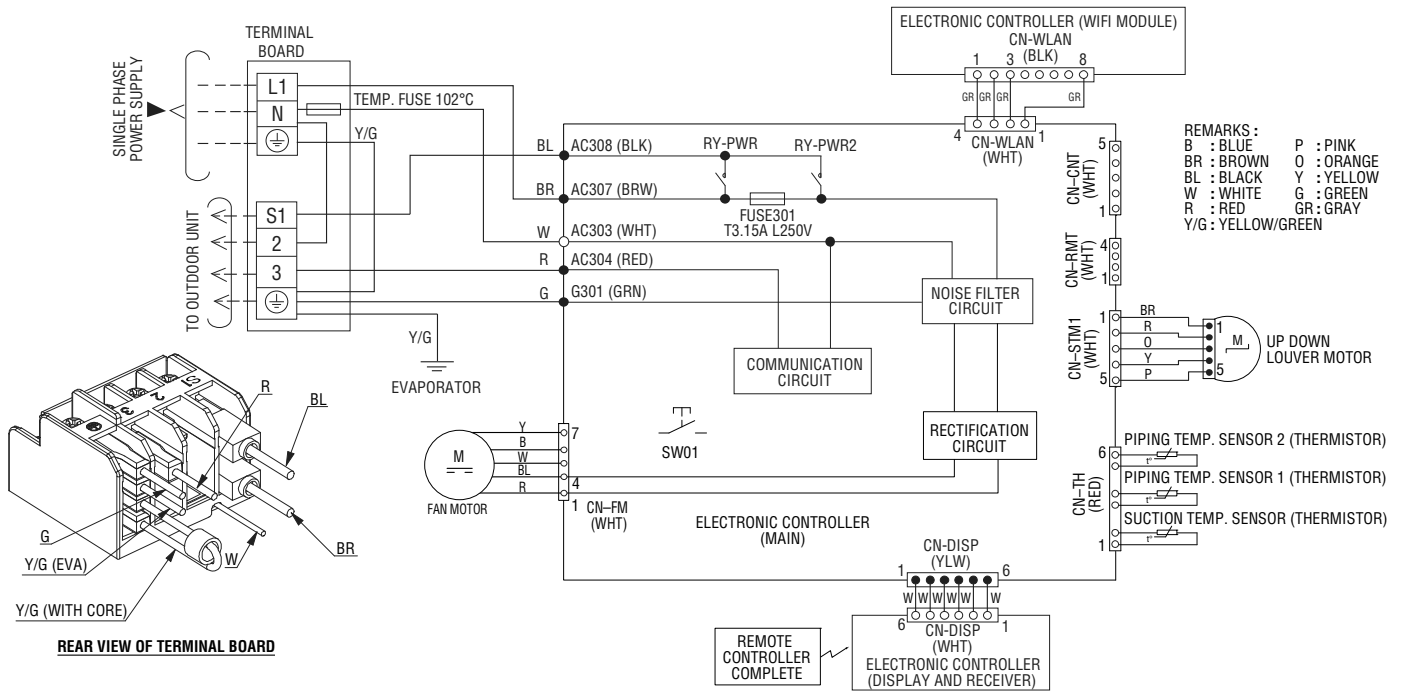

## 9.1.2 CS-TZ60WKEW CS-TZ71WKEW

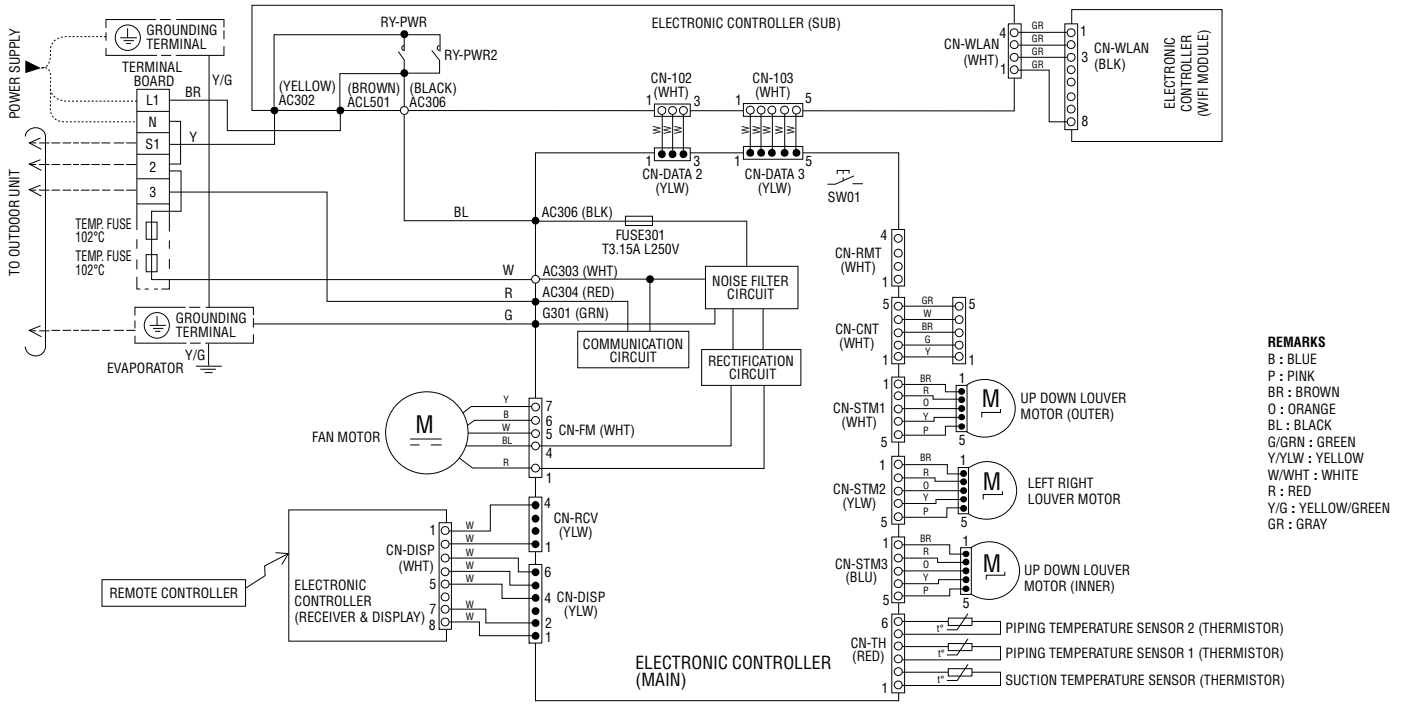

## 9.2 Outdoor Unit

### 9.2.1 CU-TZ20WKE CU-TZ25WKE CU-TZ35WKE CU-TZ42WKE CU-RZ20WKE CU-RZ25WKE CU-RZ35WKE

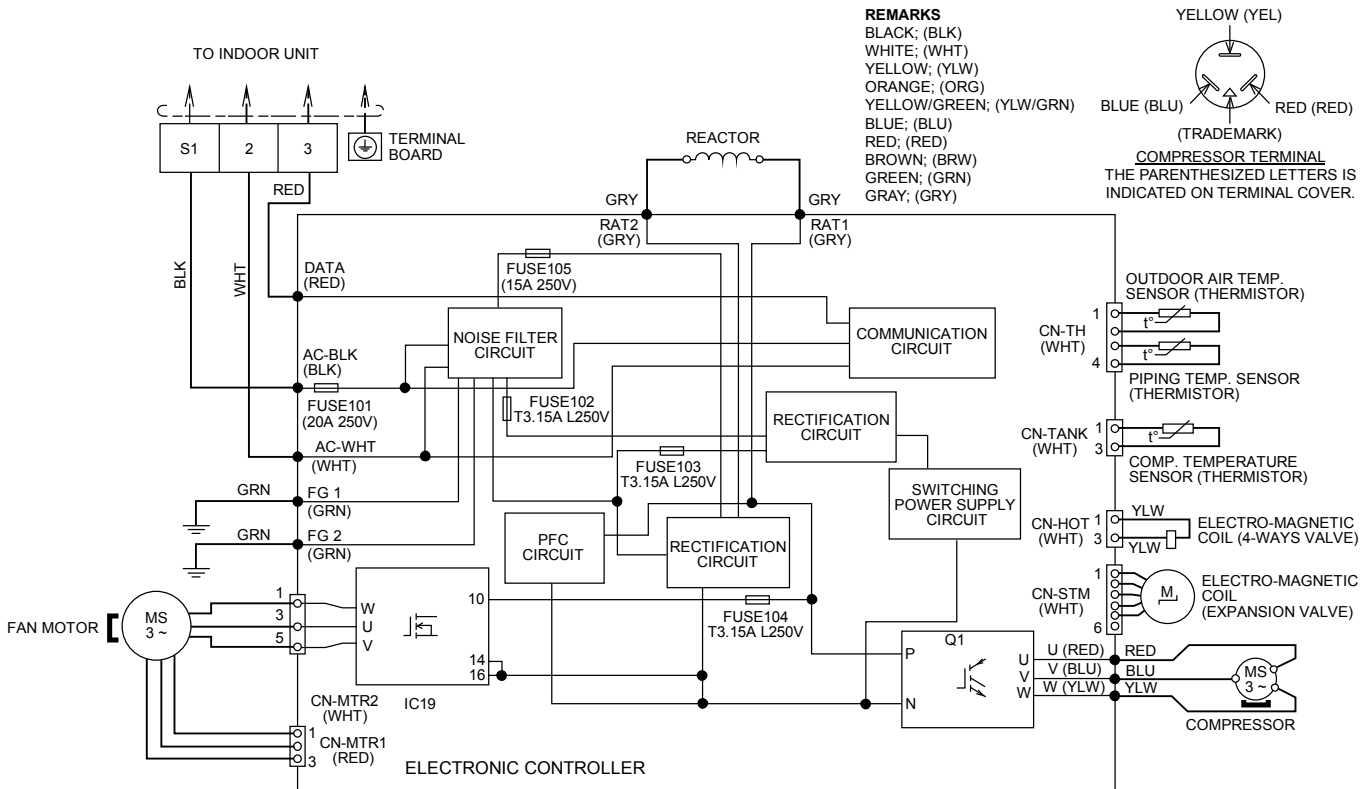

Resistance of Compressor Windings

MODEL	CU-TZ20WKE / CU-RZ20WKE	CU-TZ35WKE / CU-RZ35WKE	CU-TZ25WKE / CU-RZ25WKE	CU-TZ42WKE
CONNECTION	9GS064XAA21 (Ω)	9RS102XMA21 (Ω)	9GS075XAA21 (Ω)	9RS120XAA21 (Ω)
U-V	2.993	1.780	2.993	1.211
U-W	2.993	1.780	2.993	1.211
V-W	2.993	1.780	2.993	1.211

Note: Resistance at 20°C of ambient temperature.

## 9.2.2 CU-TZ50WKE CU-TZ60WKE CU-TZ71WKE CU-RZ50WKE

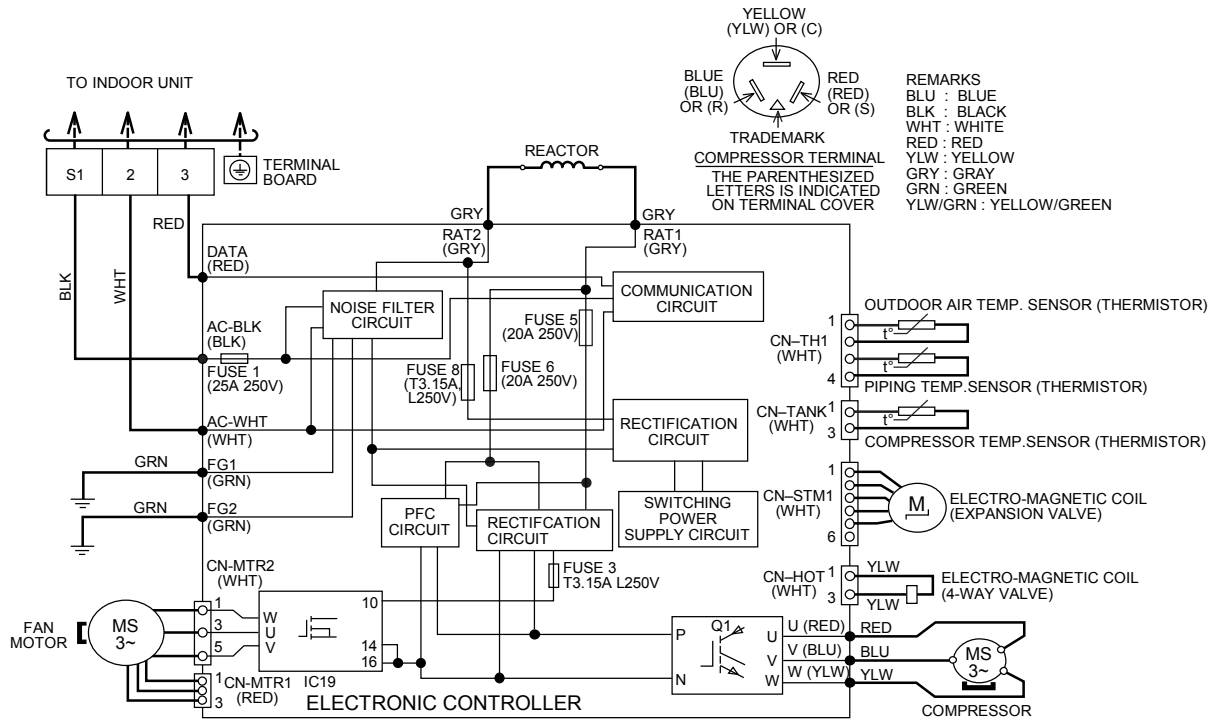

Resistance of Compressor Windings

MODEL	CU-TZ50WKE / CU-TZ60WKE / CU-RZ50WKE /	CU-TZ71WKE
CONNECTION	9RD132XAB21 (Ω)	9KD240XBA21 (Ω)
U-V	1.897	0.720
U-W	1.907	0.726
V-W	1.882	0.708

Note: Resistance at 20°C of ambient temperature.

# 10. Electronic Circuit Diagram

## 10.1 Indoor Unit

### 10.1.1 CS-TZ20WKEW CS-TZ25WKEW CS-TZ35WKEW CS-TZ42WKEW CS-TZ50WKEW CS-RZ20WKEW CS-RZ25WKEW CS-RZ35WKEW CS-RZ50WKEW

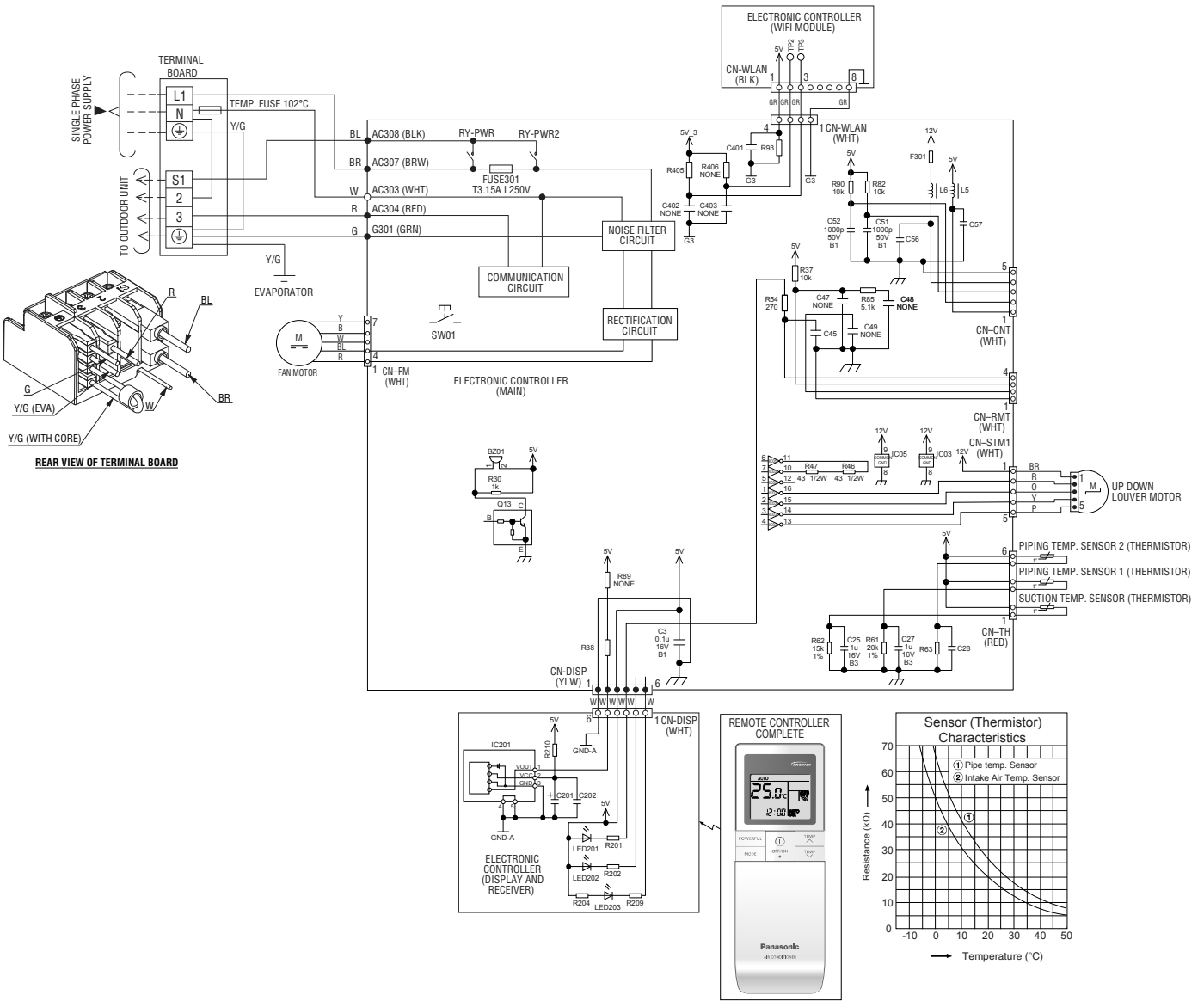

# 10.1.2 CS-TZ60WKEW CS-TZ71WKEW

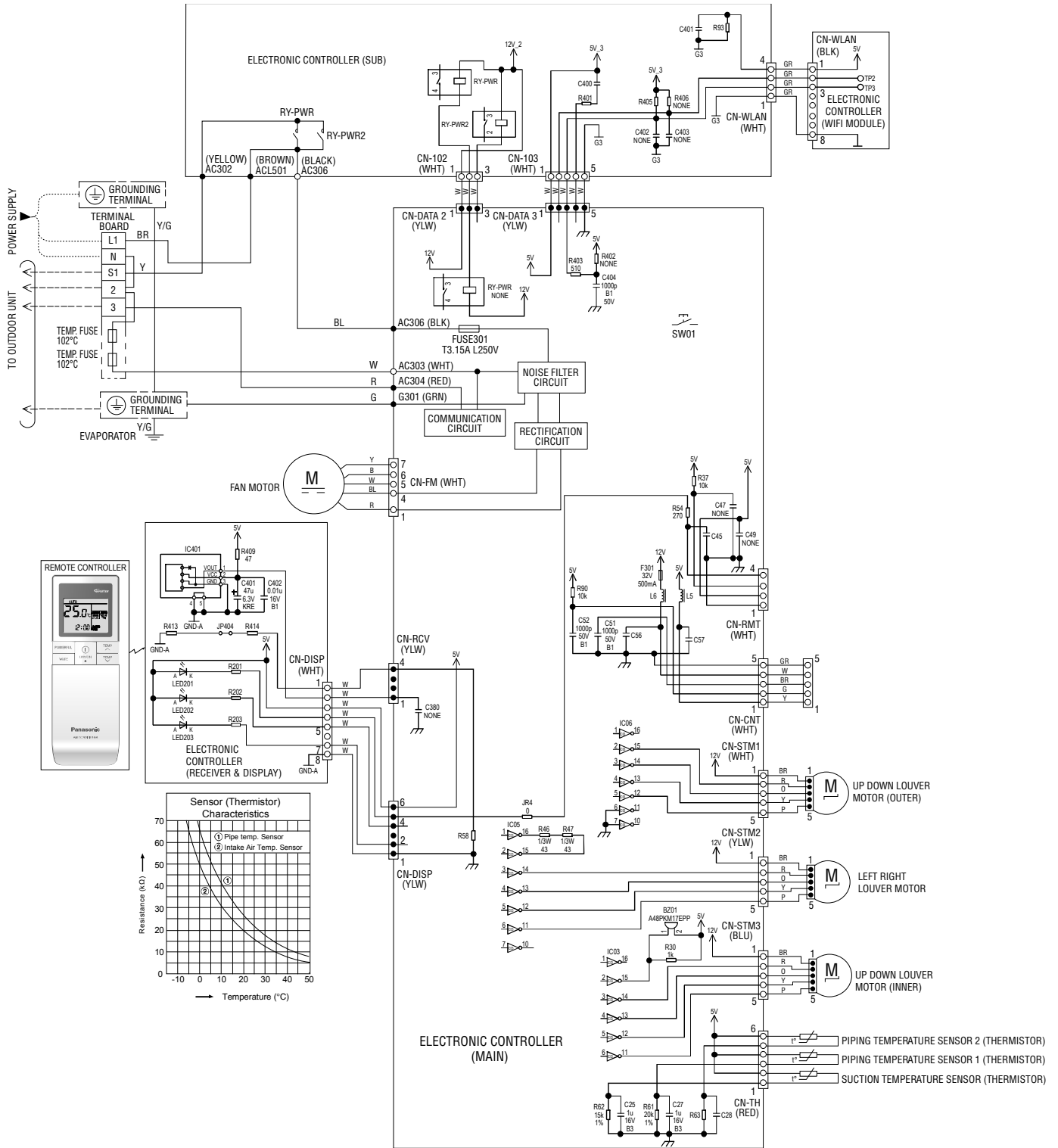

## 10.2 Outdoor Unit

### 10.2.1 CU-TZ20WKE CU-TZ25WKE CU-TZ35WKE CU-TZ42WKE CU-RZ20WKE CU-RZ25WKE CU-RZ35WKE

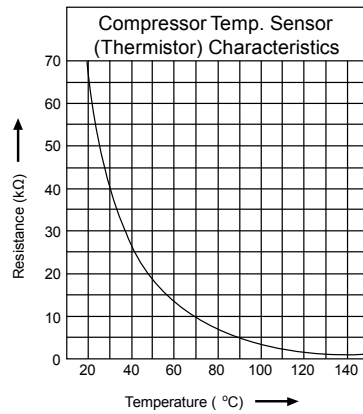
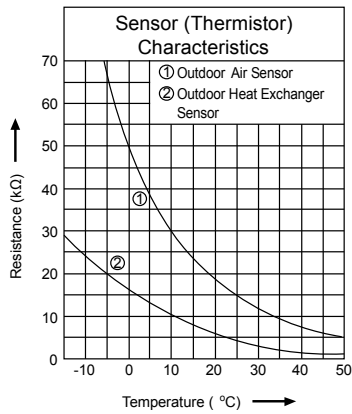
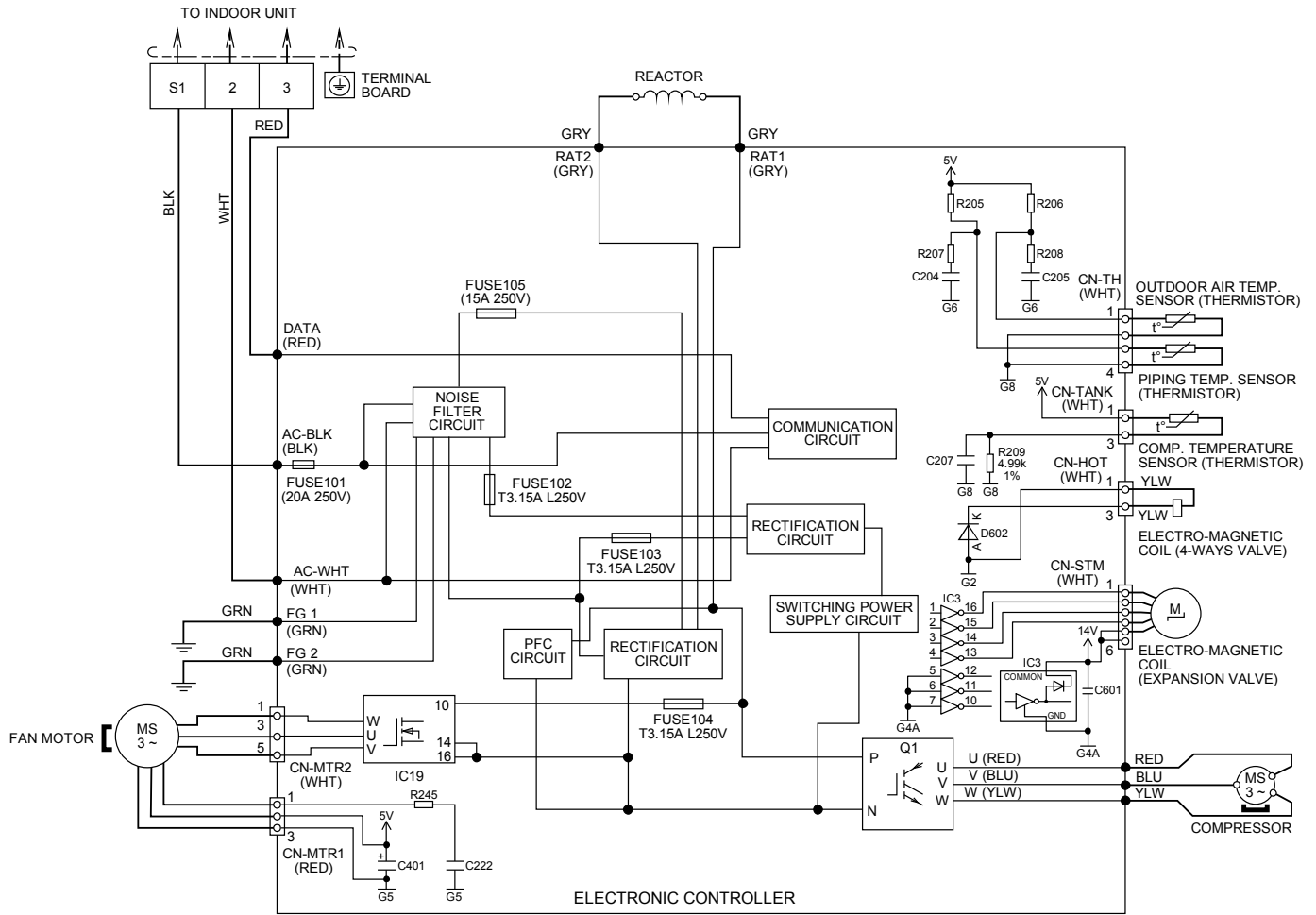

# 10.2.2 CU-TZ50WKE CU-TZ60WKE CU-TZ71WKE CU-RZ50WKE

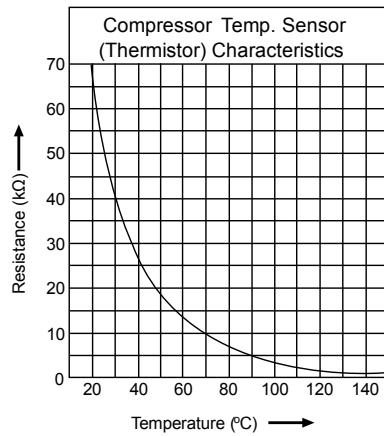
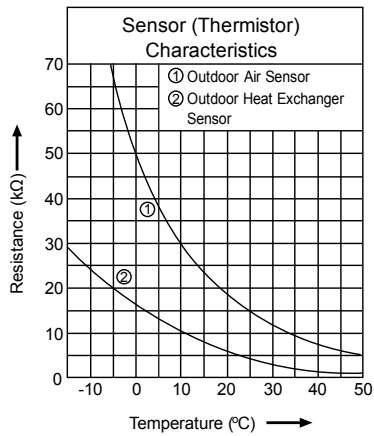
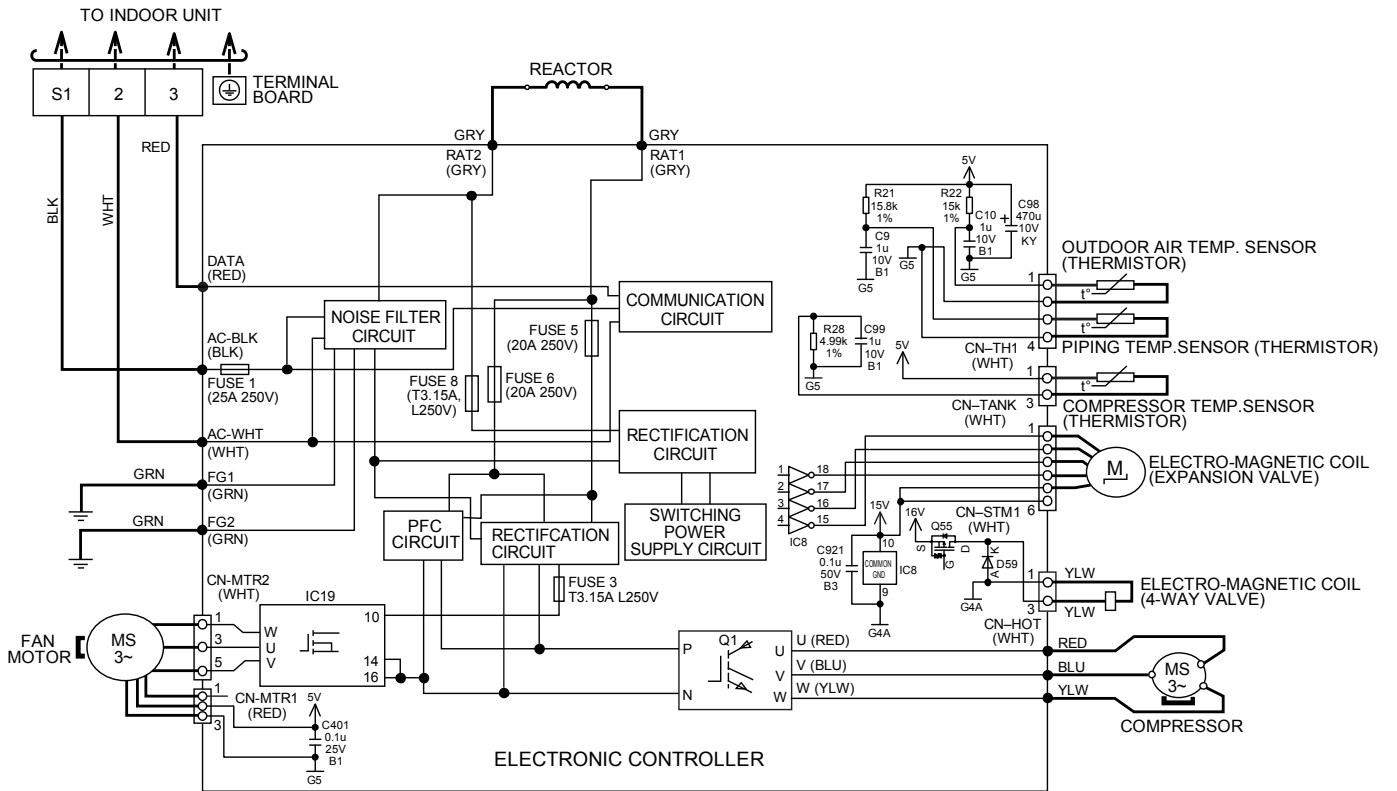

# 11. Printed Circuit Board

## 11.1 Indoor Unit

### 11.1.1 Main Printed Circuit Board

- 11.1.1.1 CS-TZ20WKEW CS-TZ25WKEW CS-TZ35WKEW CS-TZ42WKEW  
CS-TZ50WKEW  
CS-RZ20WKEW CS-RZ25WKEW CS-RZ35WKEW CS-RZ50WKEW

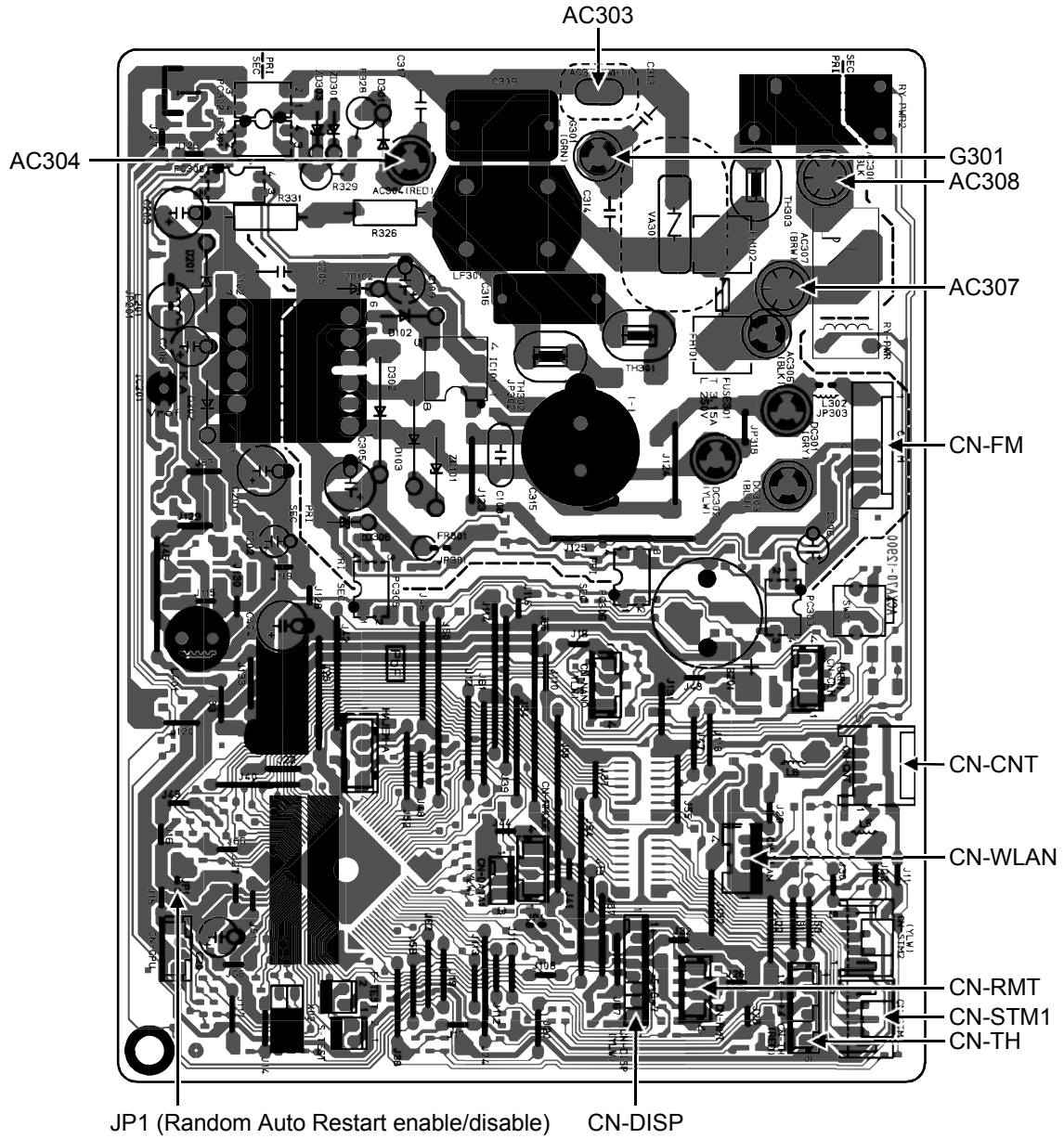



## 11.1.2 Indicator Printed Circuit Board

### 11.1.2.1 CS-TZ20WKEW CS-TZ25WKEW CS-TZ35WKEW CS-TZ42WKEW CS-TZ50WKEW CS-RZ20WKEW CS-RZ25WKEW CS-RZ35WKEW CS-RZ50WKEW

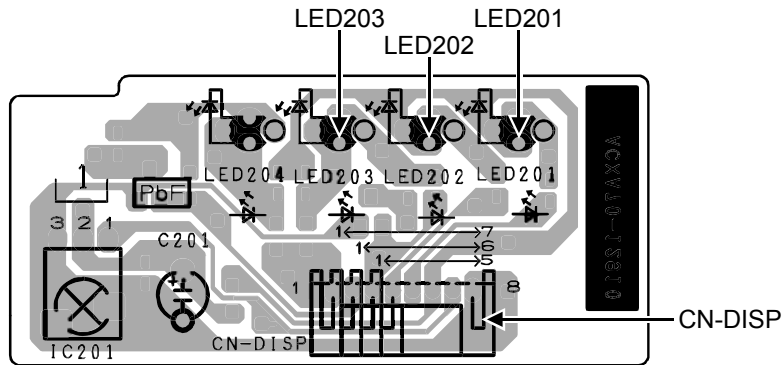

### 11.1.2.2 CS-TZ60WKEW CS-TZ71WKEW

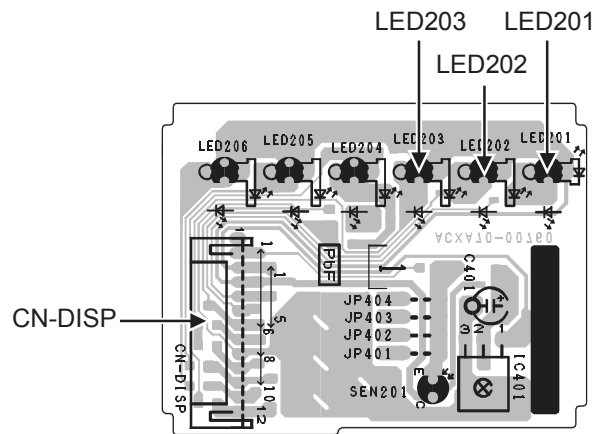

## 11.1.3 Sub Printed Circuit Board

### 11.1.3.1 CS-TZ60WKEW CS-TZ71WKEW

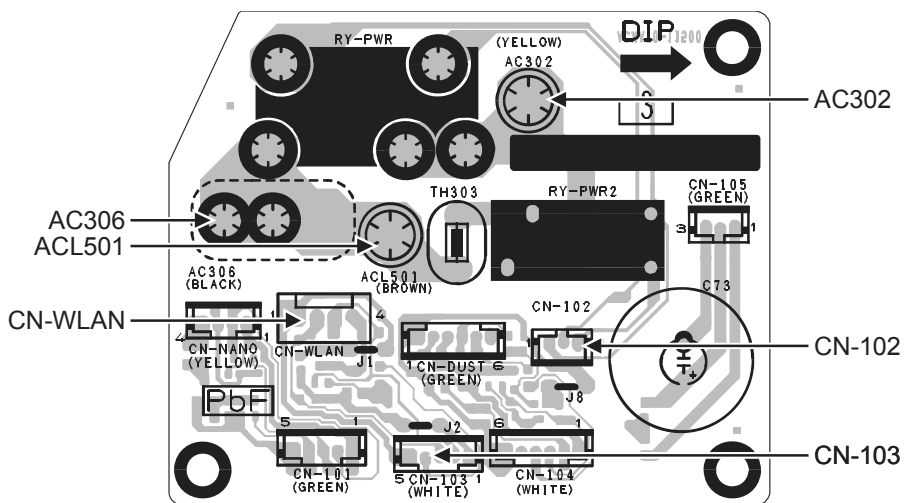

### 11.1.4 WIFI Module Printed Circuit Board

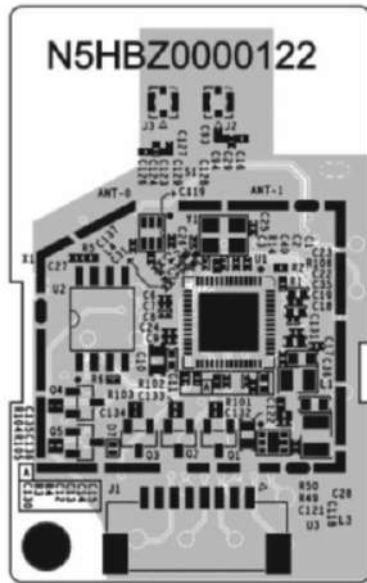

## 11.2 Outdoor Unit

### 11.2.1 CU-TZ20WKE CU-TZ25WKE CU-TZ35WKE CU-TZ42WKE CU-RZ20WKE CU-RZ25WKE CU-RZ35WKE

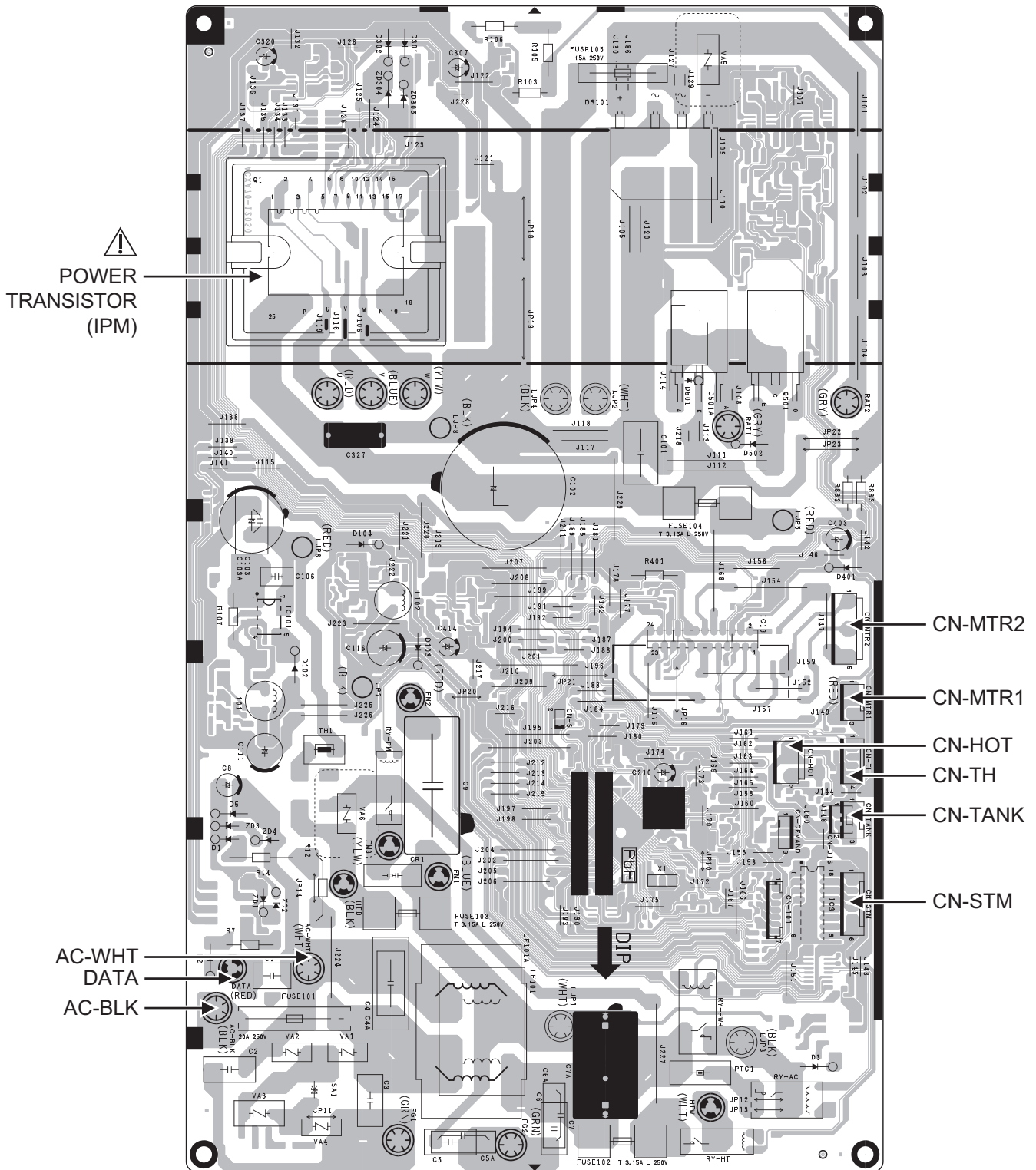

11.2.2 CU-TZ50WKE CU-TZ60WKE CU-RZ50WKE

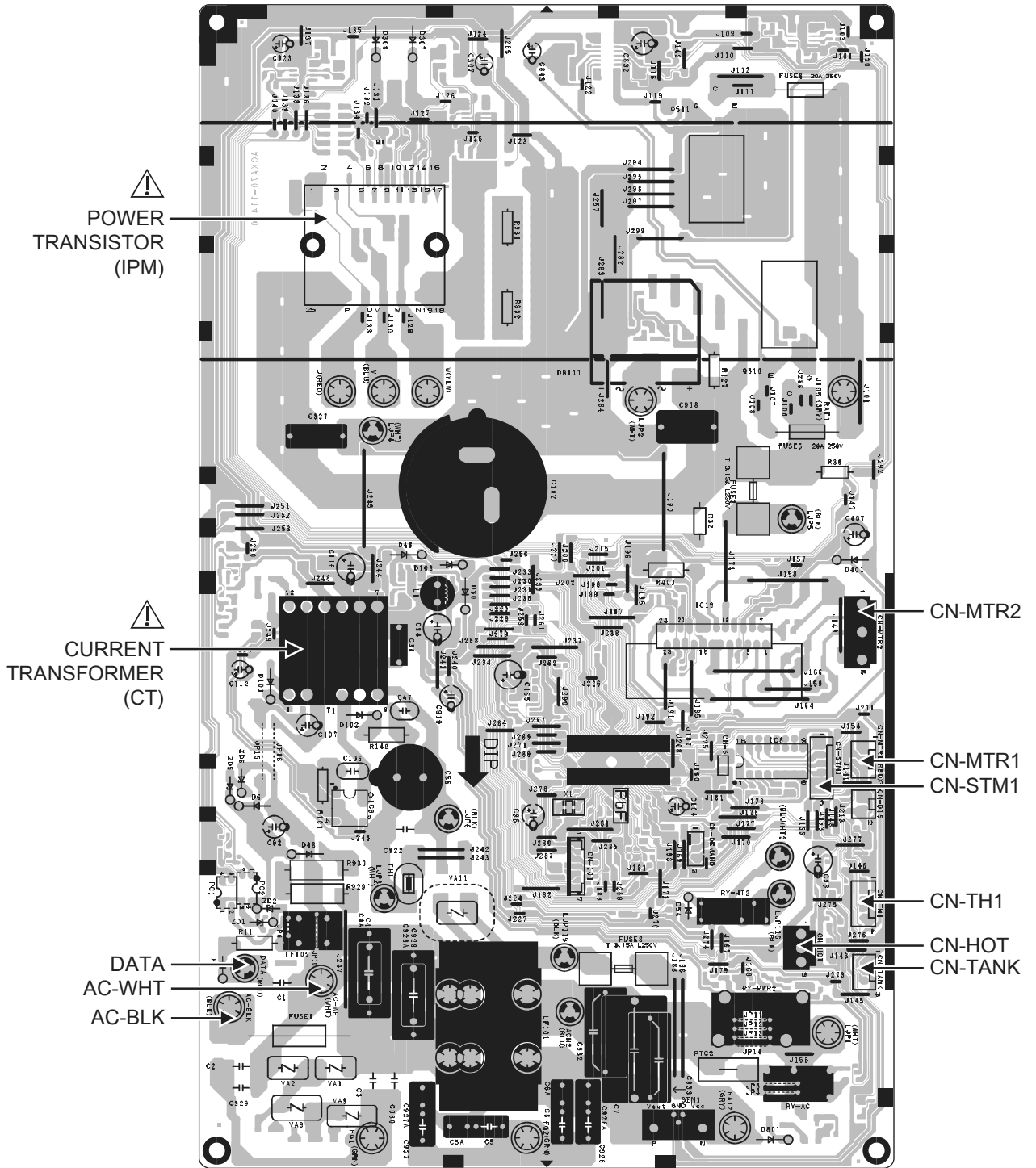

### 11.2.3 CU-TZ71WKE

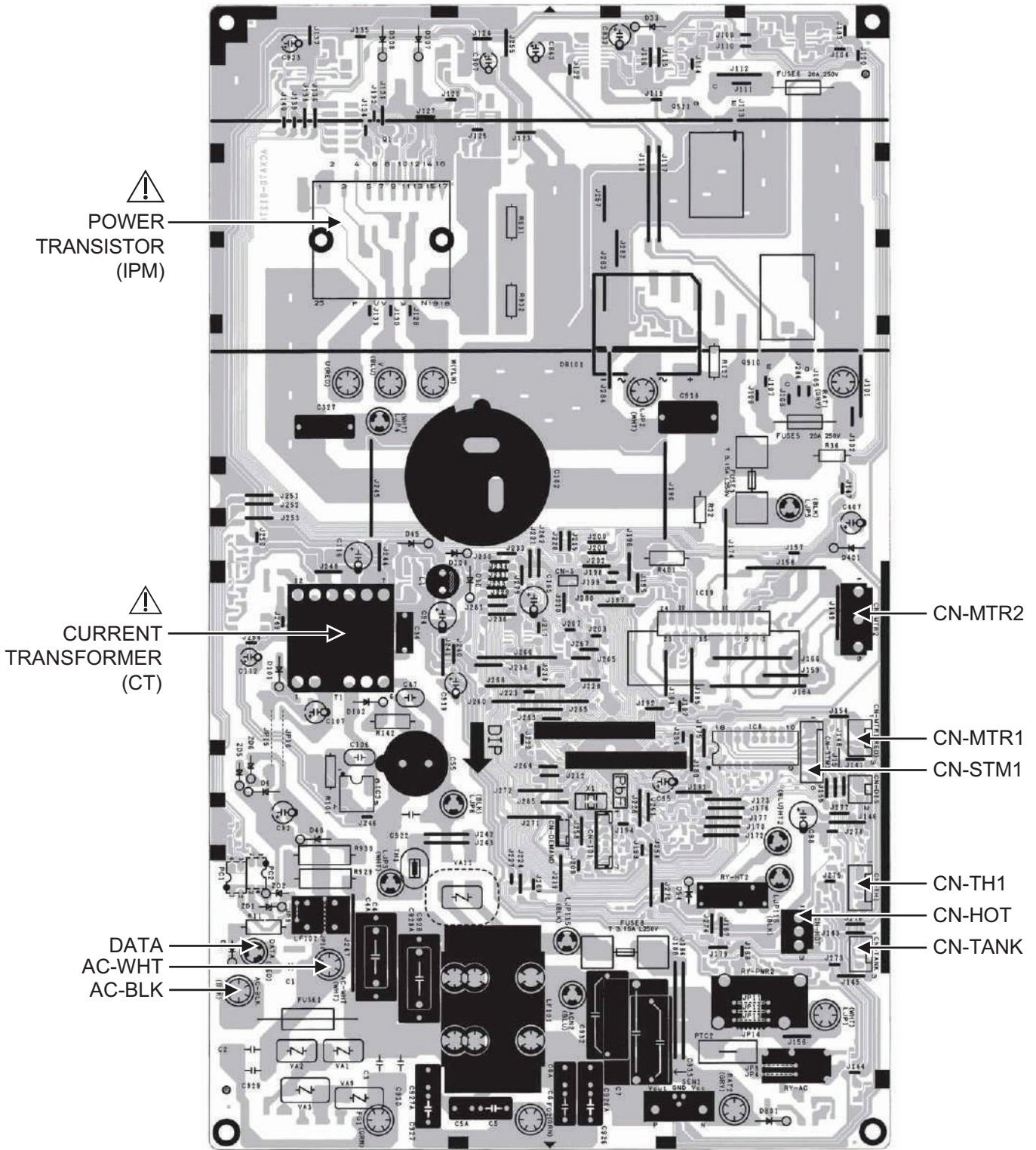

# 12. Installation Instruction

## 12.1 Select the Best Location

### 12.1.1 Indoor Unit

- Do not install the unit in excessive oil fume area such as kitchen, workshop and etc.
- There should not be any heat source or steam near the unit.
- There should not be any obstacles blocking the air circulation.
- A place where air circulation in the room is good.
- A place where drainage can be easily done.
- A place where noise prevention is taken into consideration.
- Do not install the unit near the door way.
- Ensure the spaces indicated by arrows from the wall, ceiling, fence or other obstacles.
- Indoor unit of this air conditioner shall be installed in a height of at least 1.8 m.

### 12.1.2 Indoor/Outdoor Unit Installation Diagram

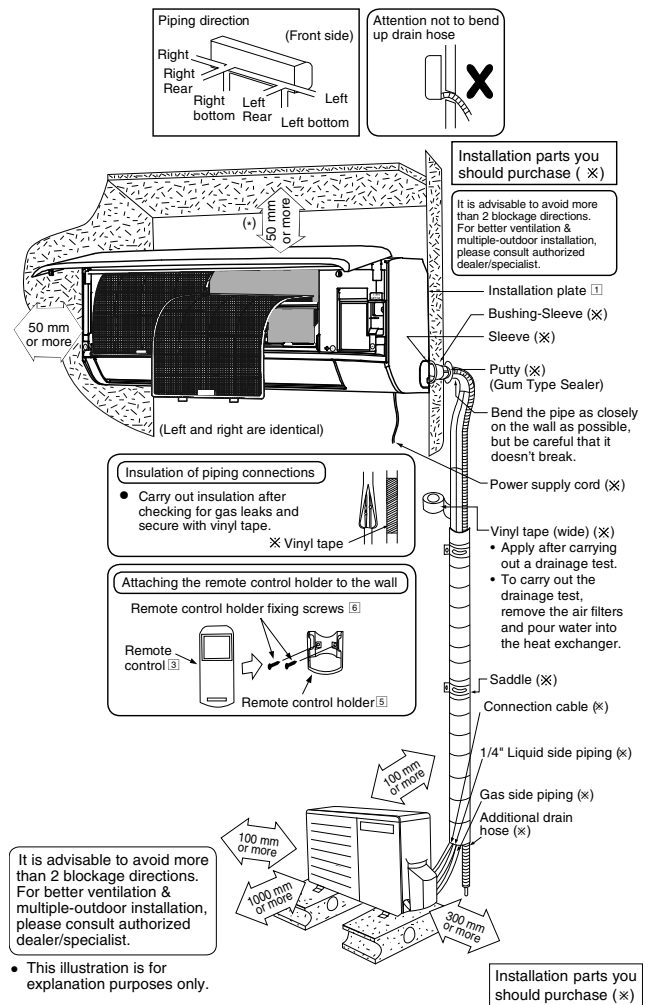

Table A

Model	Capacity W (HP)	Max. Refrigerant Charge (kg)	Indoor A <sub>min</sub> (m <sup>2</sup> )
TZ20***, RZ20***	3/4HP	0.62	Not applicable (*)
TZ25***, RZ25***	1.0HP	0.75	Not applicable (*)
TZ35***, RZ35***	1.5HP	0.85	Not applicable (*)
TZ42***	1.75HP	0.87	Not applicable (*)
TZ50***, RZ50***	2.0HP	1.33	Not applicable (*)
TZ60***	2.25HP	1.52	Not applicable (*)
TZ71***	2.5HP	1.82	Not applicable (*)

(\*) Systems with total refrigerant charge, m<sub>c</sub>, lower than 1.84kg are not subjected to any room area requirements.

\* Table "A" only applicable for single split connection.

\* In case of connection to outdoor multi inverter, refer to installation manual at outdoor unit.

$$A_{min} = (m_c / (2.5 \times (LFL)^{(5/4)} \times h_0))^2$$

\*\* not less than safety factor margin

A<sub>min</sub> = Required minimum room area, in m<sup>2</sup>

m<sub>c</sub> = Refrigerant charge in appliance, in kg

LFL = Lower flammability limit (0.307 kg/m<sup>3</sup>)

h<sub>0</sub> = Installation height of the appliance (1.8 m for wall mounted)

SF = Safety factor with a value of 0.75

\*\* The required minimum room area, A<sub>min</sub>, shall also be governed by the safety factor margin formula below :

$$A_{\min} = m_c / (SF \times LFL \times h_0)$$

The higher value shall be taken when determining the room area.

- This illustration is for explanation purposes only. The indoor unit will actually face a different way.

(\*) If holder at the rear of chassis (Refer column "12.2.3 Indoor Unit Installation") need to be used to prop up the unit, this distance shall be 65 mm or more.

### 12.1.3 Outdoor Unit

- If an awning is built over the unit to prevent direct sunlight or rain, be careful that heat radiation from the condenser is not obstructed.
- There should not be any animal or plant which could be affected by hot air discharged.
- Keep the spaces indicated by arrows from wall, ceiling, fence or other obstacles.
- Do not place any obstacles which may cause a short circuit of the discharged air.
- If piping length is over the [piping length for additional gas], additional refrigerant should be added as shown in the table.

Table A

Model	Capacity W (HP)	Piping size		Std. Length (m)	Max Elevation (m)	Min. Piping Length (m)	Max. Piping Length (m)	Additional Refrigerant (g/m)	Piping Length for add. gas (m)	Max. Refrigerant Charge (kg)	Indoor $A_{\min}$ (m <sup>2</sup> )
		Gas	Liquid								
TZ20***, RZ20***	3/4HP	9.52 mm (3/8")	6.35 mm (1/4")	5	15	3	15	10	7.5	0.62	Not applicable (*)
TZ25***, RZ25***	1.0HP				15	3	15	10	7.5	0.75	Not applicable (*)
TZ35***, RZ35***	1.5HP				15	3	15	10	7.5	0.85	Not applicable (*)
TZ42***	1.75HP	12.7 mm (1/2")			15	3	15	10	7.5	0.87	Not applicable (*)
TZ50***, RZ50***	2.0HP				15	3	20	15	7.5	1.33	Not applicable (*)
TZ60***	2.25HP				15	3	30	15	10	1.52	Not applicable (*)
TZ71***	2.5HP				20	3	30	25	10	1.82	Not applicable (*)

(\*) Systems with total refrigerant charge,  $m_c$ , lower than 1.84kg are not subjected to any room area requirements.

Example: For TZ20\*\*\*

If the unit is installed at 10 m distance, the quantity of additional refrigerant should be 25 g .... (10-7.5) m x 10 g/m = 25 g.

$$A_{\min} = (m_c / (2.5 \times (LFL)^{5/4} \times h_0))^2$$

\*\* not less than safety factor margin

$A_{\min}$  = Required minimum room area, in m<sup>2</sup>

$m_c$  = Refrigerant charge in appliance, in kg

$LFL$  = Lower flammability limit (0.307 kg/m<sup>3</sup>)

$h_0$  = Installation height of the appliance (1.8 m for wall mounted)

$SF$  = Safety factor with a value of 0.75

\*\* The required minimum room area,  $A_{\min}$ , shall also be governed by the safety factor margin formula below :

$$A_{\min} = m_c / (SF \times LFL \times h_0)$$

The higher value shall be taken when determining the room area.

## 12.2 Indoor Unit

### 12.2.1 How to Fix Installation Plate

The mounting wall shall be strong and solid enough to prevent it from vibration.

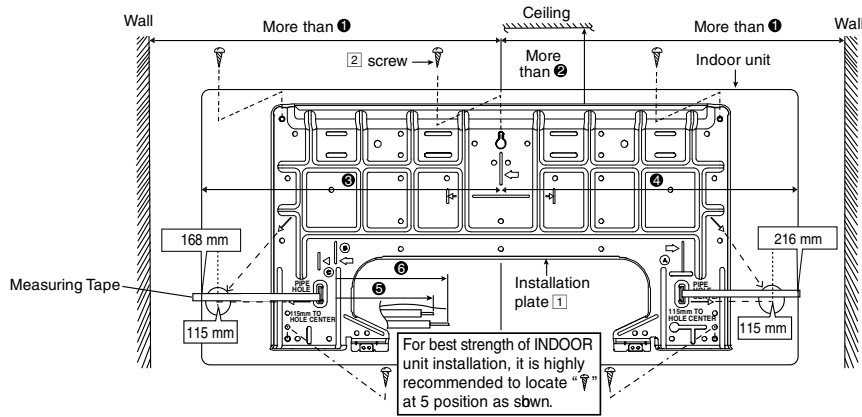

Model	Dimension					
	①	②	③	④	⑤	⑥
TZ20***, TZ25***, TZ35***, TZ42***, TZ50*** RZ20***, RZ25***, RZ35***, RZ50***	465 mm	70 mm ( * )	365 mm	415 mm	60 mm	120 mm

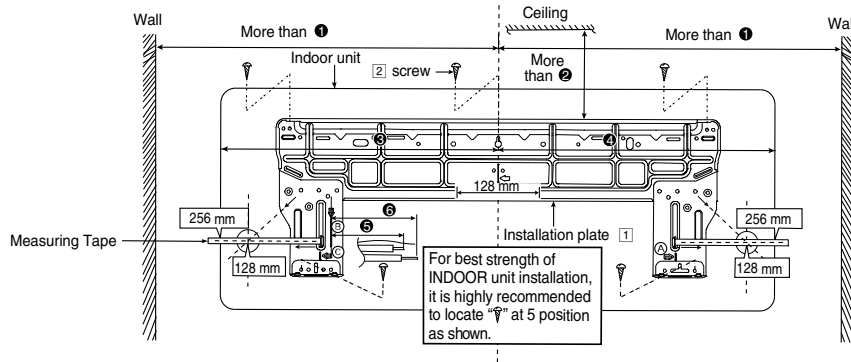

Model	Dimension					
	①	②	③	④	⑤	⑥
TZ60***, TZ71***	605 mm	80 mm	550 mm	550 mm	270 mm	320 mm

The center of installation plate should be at more than ① at right and left of the wall.

The distance from installation plate edge to ceiling should more than ②.

From installation plate center to unit's left side is ③.

From installation plate center to unit's right side is ④.

⑤ : For left side piping, piping connection for liquid should be about ⑤ from this line.

⑥ : For left side piping, piping connection for gas should be about ⑥ from this line.

1 Mount the installation plate on the wall with 5 screws or more (at least 5 screws).

(If mounting the unit on the concrete wall, consider using anchor bolts.)

○ Always mount the installation plate horizontally by aligning the marking-off line with the thread and using a level gauge.

2 Drill the piping plate hole with  $\varnothing 70$  mm hole-core drill.

○ The meeting point of the extended line is the center of the hole. Another method is by putting measuring tape at position as shown in the diagram above. The hole center is obtained by measuring the distance namely 115 mm (TZ20\*\*\*, TZ25\*\*\*, TZ35\*\*\*, TZ42\*\*\*, TZ50\*\*\*, RZ20\*\*\*, RZ25\*\*\*, RZ35\*\*\*, RZ50\*\*\*) or 128 mm (TZ60\*\*\*, TZ71\*\*\*) for left and right hole respectively.

○ Drill the piping hole at either the right or the left and the hole should be slightly slanting to the outdoor side.

Dimension ②

( \* ) :-

If holder at the rear of chassis (Refer column "12.2.3 Indoor Unit Installation") need to be used to prop up the unit, this distance shall be 85 mm or more.

## 12.2.2 To Drill a Hole in the Wall and Install a Sleeve of Piping

- 1 Insert the piping sleeve to the hole.
- 2 Fix the bushing to the sleeve.
- 3 Cut the sleeve until it extrudes about 15 mm from the wall.



### CAUTION

⚠ When the wall is hollow, please be sure to use the sleeve for tube assembly to prevent dangers caused by mice biting the connection cable.

- 4 Finish by sealing the sleeve with putty or caulking compound at the final stage.

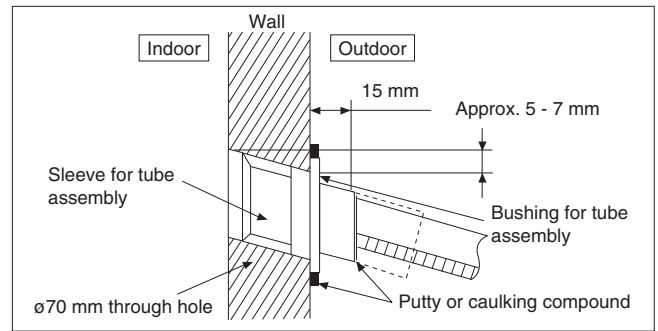

## 12.2.3 Indoor Unit Installation

Pull out the Indoor piping

- Do not turn over the unit without shock absorber during pull out the piping. It may cause intake grille damage.
- Use shock absorber during pull out the piping to protect the intake grille from damage.

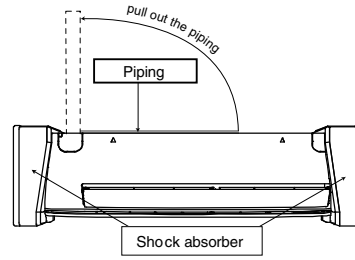
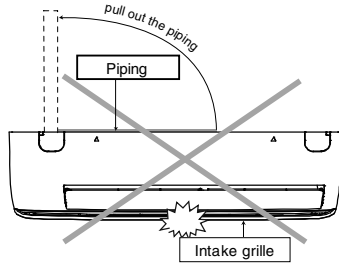

### 12.2.3.1 For the Right Rear Piping

**Step-1** Pull out the Indoor piping

**Step-2** Install the Indoor Unit

**Step-3** Secure the Indoor Unit

**Step-4** Insert the power supply cord and connection cable

- Insert the cables from bottom of the unit through the control board hole until terminal board area.

### 12.2.3.2 For the Right and Right Bottom Piping

**Step-1** Pull out the Indoor piping

**Step-2** Install the Indoor Unit

**Step-3** Insert the power supply cord and connection cable

- Insert the cables from bottom of the unit through the control board hole until terminal board area.

**Step-4** Secure the Indoor Unit

### 12.2.3.3 For the Embedded Piping

**Step-1** Change the drain hose position

**Step-2** Bend the embedded piping

- Use a spring bender or equivalent to bend the piping so that the piping is not crushed.

**Step-3** Pull the connection cable into Indoor Unit

- The power supply cord and indoor unit and outdoor unit connection cable can be connected without removing the front grille.

**Step-4** Cut and flare the embedded piping

- When determining the dimensions of the piping, slide the unit all the way to the left on the installation plate.
- Refer to the column "Cutting and flaring the piping".

**Step-5** Install the Indoor Unit

**Step-6** Connect the piping

- Please refer to "Connecting the piping" column in outdoor unit section. (Below steps are done after connecting the outdoor piping and gas-leakage confirmation.)

**Step-7** Insulate and finish the piping

- Please refer to "Insulation of piping connection" column as mentioned in indoor/outdoor unit installation.

**Step-8** Secure the Indoor Unit

#### Right Rear piping

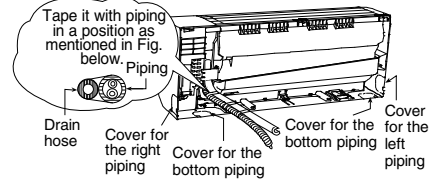

#### How to keep the cover

In case of the cover is cut, keep the cover at the rear of chassis as shown in the illustration for future reinstallation.

(Left, right and 2 bottom covers for piping.)

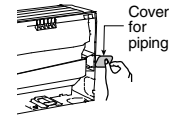

#### Right and Right bottom piping

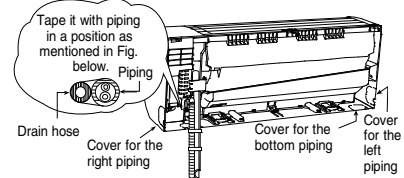

#### Install the indoor unit

Hook the indoor unit onto the upper portion of installation plate.

(Engage the indoor unit with the upper edge of the installation plate). Ensure the hooks are properly seated on the installation plate by moving it in left and right.

In case of embedded piping, for model (TZ20\*\*\*, TZ25\*\*\*, TZ35\*\*\*, TZ42\*\*\*, TZ50\*\*\*, RZ20\*\*\*, RZ25\*\*\*, RZ35\*\*\*, RZ50\*\*\*) there is an option to use the holder at the rear of chassis to prop up the indoor unit as shown in the illustration for ease of installation. Push the holder back to original position before secure the indoor unit.

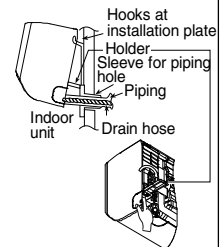

- Press the area of orange color to release holder.

#### Secure the Indoor Unit

Press the lower left and right side of the unit against the installation plate until hooks engages with their slot (sound click).

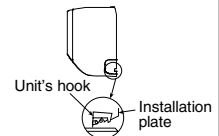

#### Insert the connection cable

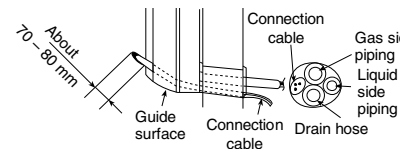

To take out the unit, push the ▽ marking at the bottom unit, and pull it slightly towards you to disengage the hooks from the unit.

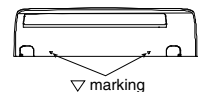

(This can be used for left rear piping also.)

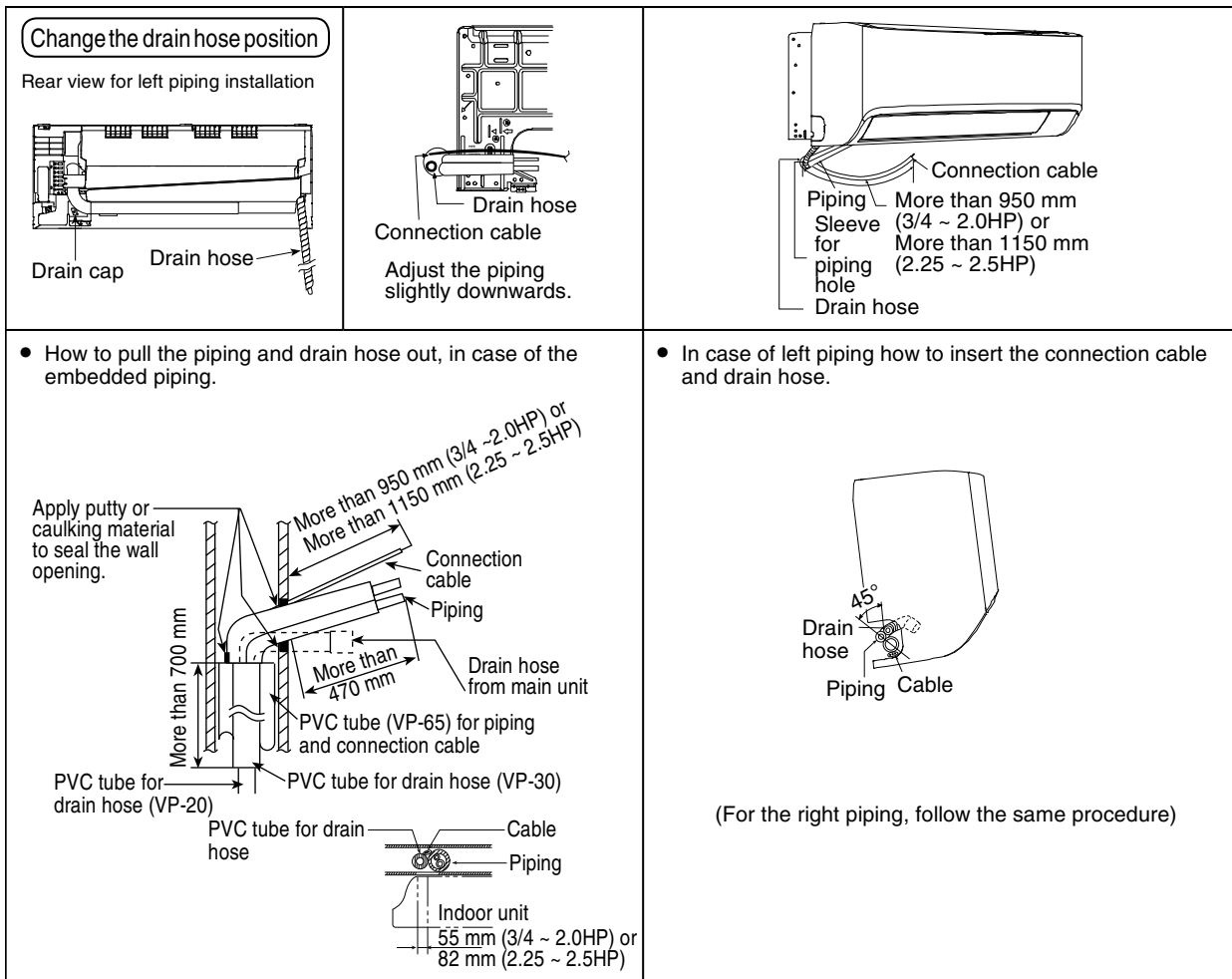

## 12.2.4 Connect the Cable to the Indoor Unit

- The power supply cord, indoor and outdoor unit connection cable can be connected without removing the front grille.
  - Install the indoor unit on the installing holder that mounted on the wall.
  - Open the front panel and grille door by loosening the screw.
  - Cable connection to the power supply through Isolating Devices (Disconnecting means).
    - Connect the approved polychloroprene sheathed **power supply cord** 3 x 1.5 mm<sup>2</sup> (3/4 ~ 1.75HP) or 3 x 2.5 mm<sup>2</sup> (2.0 ~ 2.5HP), type designation 60245 IEC 57 or heavier cord to the terminal board, and connect the other end of the cable to Isolating Devices (Disconnecting means).
    - Do not use joint power supply cord. Replace the wire if the existing wire (from concealed wiring, or otherwise) is too short.
    - In unavoidable case, joining of power supply cord between isolating devices and terminal board of air conditioner shall be done socket and plug rated 15/16A (3/4 ~ 1.75HP) or 16A (2.0 ~ 2.25HP) or 20A (2.5HP). Wiring work to both socket and plug must follow to national wiring standard.
  - Bind all the **power supply cord** lead wire with tape and route the power supply cord via the left side escapement.
  - Connection cable** between indoor unit and outdoor unit shall be approved polychloroprene sheathed 4 x 1.5 mm<sup>2</sup> (3/4 ~ 1.75HP) or 4 x 2.5 mm<sup>2</sup> (2.0 ~ 2.5HP) flexible cord, type designation 60245 IEC 57 or heavier cord.
  - Bind all the indoor and outdoor **Connection cable** with tape and route the connection cable via the right side escapement.
  - Remove the tapes and connect the power supply cord and connection cable between indoor unit and outdoor unit according to the diagram below.

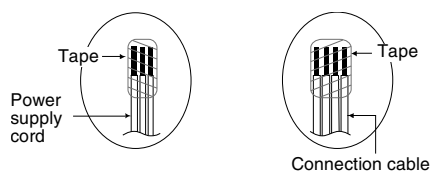

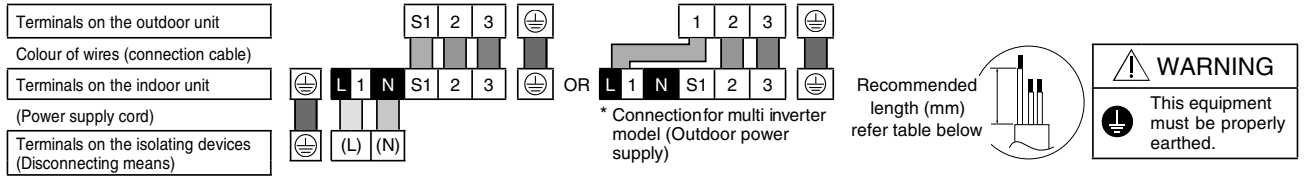

Model	TZ20***, TZ25***, TZ35***, TZ42***, TZ50***, RZ20***, RZ25***, RZ35***, RZ50***
-------	---

Recommended length (mm)	a	b	c	d	e	f	g
	30	30	60	45	40	35	55

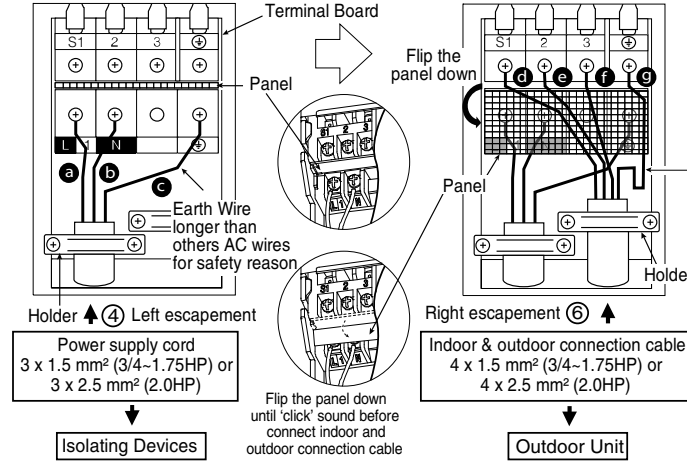

Model	TZ60***, TZ71***						
Recommended length (mm)	a	b	c	d	e	f	g
	55	35	35	50	40	35	60

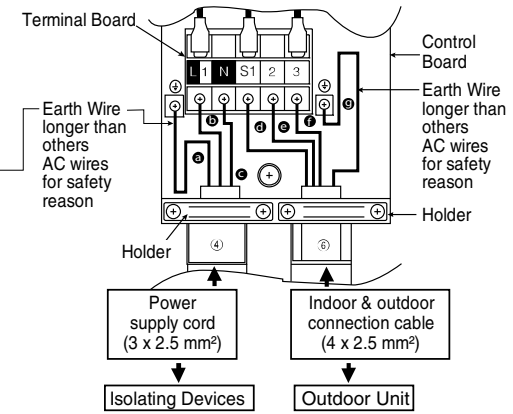

### WIRE STRIPPING, CONNECTING REQUIREMENT

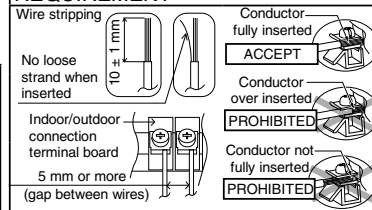

**WARNING**

**RISK OF FIRE**  
JOINING OF WIRES MAY CAUSE OVERHEATING AND FIRE.

Note:

- Isolating Devices (Disconnecting means) should have minimum 3.0 mm contact gap.
- Ensure the colour of wires of outdoor unit and the terminal Nos. are the same to the indoor's respectively.
- Earth wire shall be Yellow/Green (Y/G) in colour and longer than other AC wires as shown in the figure for the electrical safety in case of the slipping out of the cord from the anchorage.

- Secure firmly the power supply cord and connecting cable onto the control board with the holder. Do not overtighten holder screw, as this may damage the holder.
- Close grille door by tighten with screw and close the front panel.

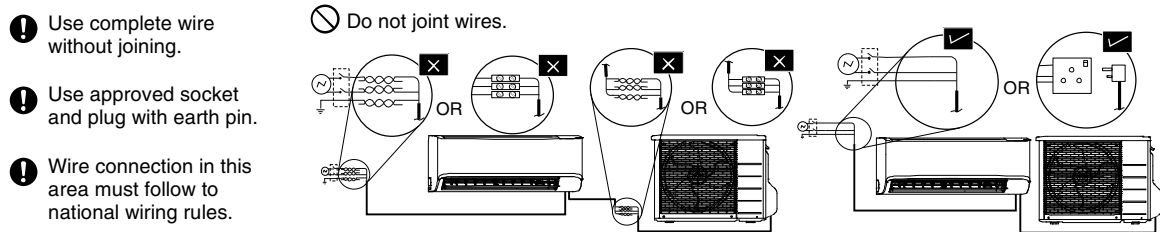

**CAUTION**

Do not connect power supply to indoor and outdoor unit at the same time. Risk of fire if wrong connection of power supply.

## 12.2.5 Connect the Piping

### 12.2.5.1 Connecting the Piping to Indoor

For connection joint of all model (except R32 model)  
Please make flare after inserting flare nut (locate at joint portion of tube assembly) onto the copper pipe. (In case of using long piping)

Connect the piping

- Align the center of piping and sufficiently tighten the flare nut with fingers.
- Further tighten the flare nut with torque wrench in specified torque as stated in the table.

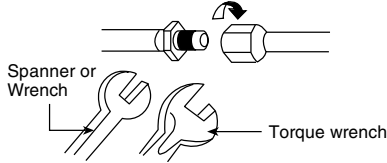

Additional Precautions For R32 Models when connecting by flaring at indoor side

⚠ Ensure to do the re-flaring of pipes before connecting to units to avoid leaking.

Seal sufficiently the flare nut (both gas and liquid sides) with neutral cure (Alkoxy type) & ammonia-free silicone sealant and insulation material to avoid the gas leak caused by freezing.

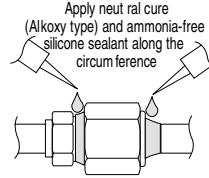

Neutral cure (Alkoxy type) & ammonia-free silicone sealant is only to be applied after pressure testing and cleaning up by following instructions of sealant, only to the outside of the connection. The aim is to prevent moisture from entering the connection joint and possible occurrence of freezing. Curing sealant will take some time. Make sure sealant will not peel off when wrapping the insulation.

### 12.2.5.2 Connecting the Piping to Outdoor

Decide piping length and then cut by using pipe cutter. Remove burrs from cut edge.

Make flare after inserting the flare nut (locate at valve) onto the copper pipe.

Align center of piping to valve and then tighten with torque wrench to the specified torque as stated in the table.

⚠ Do not overtighten, overtightening may cause gas leakage.

Piping size	Torque
6.35 mm (1/4")	[18 N•m (1.8 kgf•m)]
9.52 mm (3/8")	[42 N•m (4.3 kgf•m)]
12.7 mm (1/2")	[55 N•m (5.6 kgf•m)]
15.88 mm (5/8")	[65 N•m (6.6 kgf•m)]
19.05 mm (3/4")	[100 N•m (10.2 kgf•m)]

### 12.2.5.3 Connecting the Piping to Outdoor Multi

Decide piping length and then cut by using pipe cutter.

Remove burrs from cut edge. Make flare after inserting the flare nut (locate at valve) onto the copper pipe. Align center of piping to valve and then tighten with torque wrench to the specified torque as stated in the table.

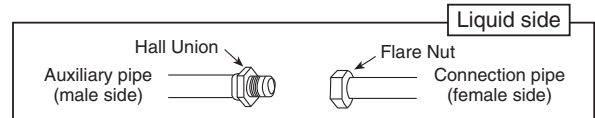

\* For Gas side piping please refer table and diagram below

Outdoor Multi Combination Model	R32 Model	Pipe size (refer to diagram)
	CS-TZ20***, CS-TZ25***, CS-TZ35***, CS-RZ20***, CS-RZ25***, CS-RZ35***	
CS-TZ42***, CS-TZ50***, CS-RZ50***	CU-2Z50***, CU-3Z52***, CU-3Z68***, CU-4Z68***, CU-4Z80***, CU-5Z90***, CU-2TZ50***, CU-3TZ52***	② (CZ-MA1P)
CS-TZ60***	CU-3Z68***, CU-4Z68***, CU-4Z80***, CU-5Z90***	③ (CZ-MA2P)
CS-TZ71***	CU-4Z80***, CU-5Z90***	④ (CZ-MA2P) & (CZ-MA3P)

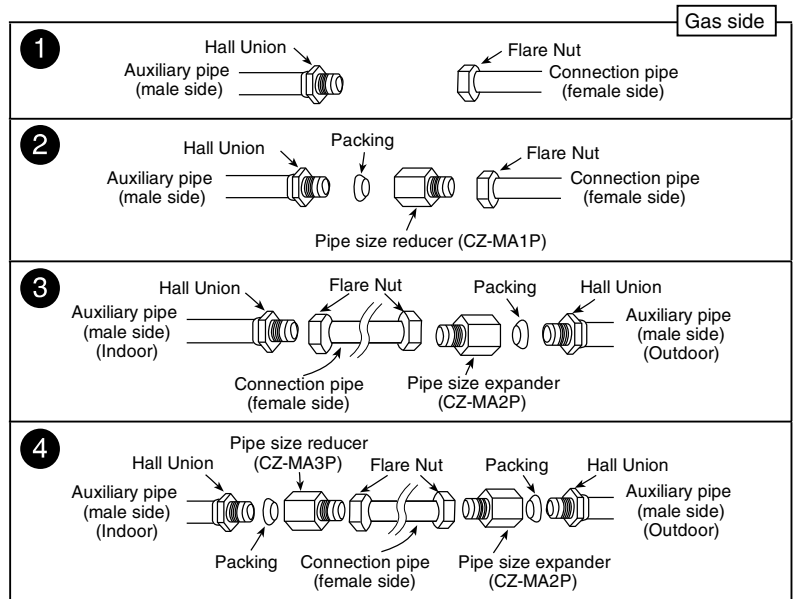

## 12.2.6 Cutting and Flaring the Piping

- 1 Please cut using pipe cutter and then remove the burrs.
- 2 Remove the burrs by using reamer. If burrs is not removed, gas leakage may be caused. Turn the piping end down to avoid the metal powder entering the pipe.
- 3 Please make flare after inserting the flare nut onto the copper pipes.

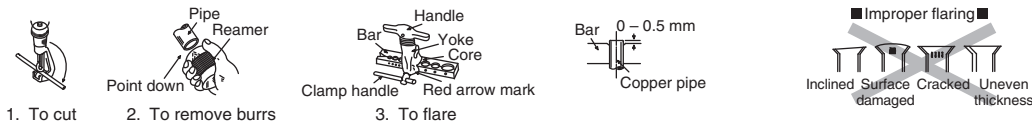

When properly flared, the internal surface of the flare will evenly shine and be of even thickness. Since the flare part comes into contact with the connections, carefully check the flare finish.

## 12.2.7 How to Take Out Front Grille

Please follow the steps below to take out front grille if necessary such as when installing or servicing.

Model	TZ20***, TZ25***, TZ35***, TZ42***, TZ50***, RZ20***, RZ25***, RZ35***, RZ50***
-------	---

- 1 Open front panel.
- 2 Remove the 3 mounting screws on the front grille as shown in the illustration below.
- 3 Slide the 3 lock knobs on the upside of front grille to unlock position.
- 4 Pull the front grille towards you to remove the front grille.

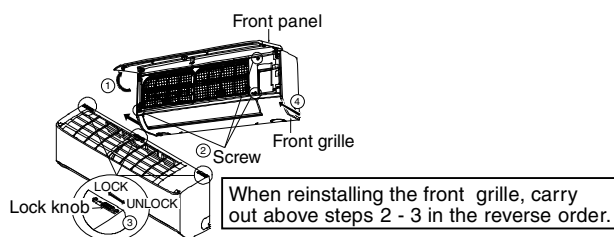

Model	TZ60***, TZ71***
-------	------------------

- 1 Set the vertical airflow direction louvers to the horizontal position.
- 2 Remove the 3 caps on the front grille as shown in the illustration below.
- 3 And then remove the 4 mounting screws.
- 4 Pull the lower section of the front grille towards you to remove the front grille.

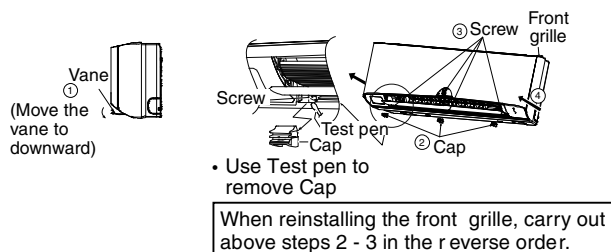

## 12.2.8 Check the Drainage

- Open front panel and remove air filters. (Drainage checking can be carried out without removing the front grille.)
- Pour a glass of water into the drain tray-styrofoam.
- Ensure that water flows out from drain hose of the indoor unit.

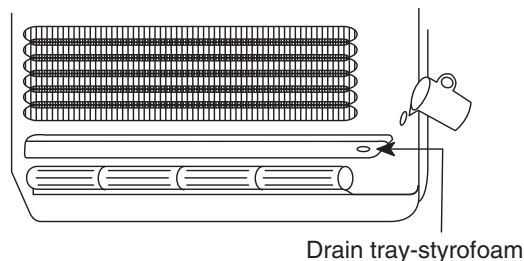

### 12.2.9 Evaluation of the Performance

- Operate the unit at cooling/heating operation mode for fifteen minutes or more.
- Measure the temperature of the intake and discharge air.
- Ensure the difference between the intake temperature and the discharge is more than 8°C during Cooling operation or more than 14°C during Heating operation.

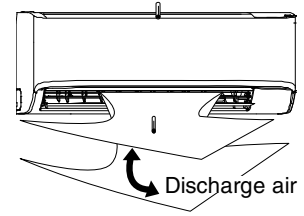

### 12.2.10 Installation of Dust Collector Filter/Air Purifying Filter

- 1 Open the front panel.
- 2 Remove the air filters.
- 3 Put the Dust Collector Filter/Air Purifying Filter into place as shown in illustration at right.

Dust Collector Filter/Air Purifying Filter

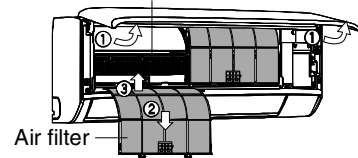

## 12.3 Outdoor Unit

### 12.3.1 Install the Outdoor Unit

- After selecting the best location, start installation to Indoor/Outdoor Unit Installation Diagram.
  - Fix the unit on concrete or rigid frame firmly and horizontally by bolt nut ( $\phi 10$  mm).  
Make sure unit install in balance level to ensure that water flow out from unit drainage hole.
  - When installing at roof, please consider strong wind and earthquake.  
Please fasten the installation stand firmly with bolt, screws or nails.

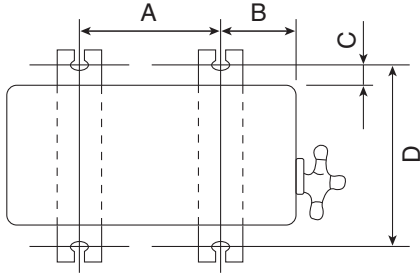

Model	A	B	C	D
TZ20***, RZ20***	570 mm	105 mm	18.5 mm	320 mm
TZ25***, RZ25***				
TZ35***, RZ35***				
TZ42***				
TZ50***, RZ50***	540 mm	160 mm	18.5 mm	330 mm
TZ60***				
TZ71***	613 mm	131 mm	24 mm	360.5 mm

### 12.3.2 Connect the Piping

#### 12.3.2.1 Connecting the Piping to Indoor

For connection joint location at outside building

Please make flare after inserting flare nut (locate at joint portion of tube assembly) onto the copper pipe.  
(In case of using long piping)

Connect the piping

- Align the center of piping and sufficiently tighten the flare nut with fingers.
- Further tighten the flare nut with torque wrench in specified torque as stated in the table.

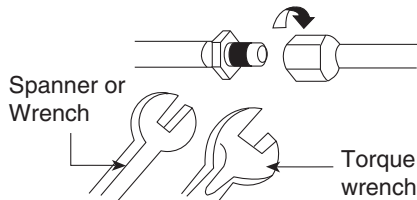

#### 12.3.2.2 Connecting the Piping to Outdoor

Decide piping length and then cut by using pipe cutter.  
Remove burrs from cut edge.

Make flare after inserting the flare nut (locate at valve) onto the copper pipe. Align center of piping to valve and then tighten with torque wrench to the specified torque as stated in the table.

For connection joint location at inside building

- Refer to indoor installation instruction.

Do not overtighten, overtightening may cause gas leakage.	
Piping size	Torque
6.35 mm (1/4")	[18 N•m (1.8 kgf•m)]
9.52 mm (3/8")	[42 N•m (4.3 kgf•m)]
12.7 mm (1/2")	[55 N•m (5.6 kgf•m)]
15.88 mm (5/8")	[65 N•m (6.6 kgf•m)]
19.05 mm (3/4")	[100 N•m (10.2 kgf•m)]

### 12.3.3 Air Tightness Test on the Refrigerating System

⊘ Do not purge the air with refrigerants but use a vacuum pump to vacuum the installation.

⚠ There is no extra refrigerant in the outdoor unit for air purging.

- Before system is charged with refrigerant and before the refrigerating system is put into operation, below site test procedure and acceptance criteria shall be verified by the certified technicians, and/or the installer.
- Be sure to check whole system for gas leakage.

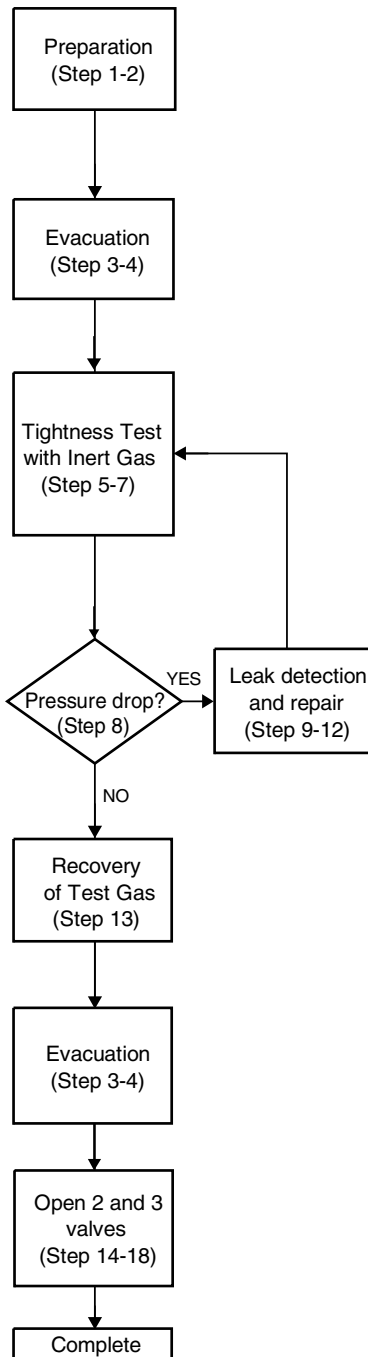

- 1 Connect a charging hose with a push pin to the Low side of a charging set and the service port of the 3-way valve.
- 2 Attach the gauge manifold set correctly and tightly. Make sure that both valves of the manifold gauge (low pressure and high pressure) is in close position.
- 3 Connect the center hose of the manifold gauge to a vacuum pump.
- 4 Turn on the power switch of the vacuum pump, then turn open the low side manifold gauge valve and make sure that the needle in the gauge moves from 0cmHg (0 MPa) to -76 cmHg (-0.1 MPa). This process continues for approximately ten minutes. Then close the low side manifold gauge valve.
- 5 Remove the vacuum pump from the centre hose and connect the center hose to cylinder of any applicable inert gas as test gas.
- 6 Charge test gas into the system and wait until the pressure within the system to reach min. 1.04MPa (10.4barg).
- 7 Wait and monitor the pressure reading on the gauges. Check if there is any pressure drop. Waiting time depends on the size of the system.
- 8 If there is any pressure drop, perform step 9-12. If there is no pressure drop, perform step 13.
- 9 Use Gas Leak Detector to check for leaks. Must use the detection equipment with a sensitivity of 5 grams per year of test gas or better.
- 10 Move the probe along the air conditioning system to check for leaks, and mark for repair.
- 11 Any leak detected and marked shall be repaired.
- 12 After repair, repeat evacuation steps 3-4 and tightness test steps 5-7. Check the pressure drop as in step 8.
- 13 If no leak, Recover the test gas. Perform evacuation of steps 3-4. Then proceed to step 14.

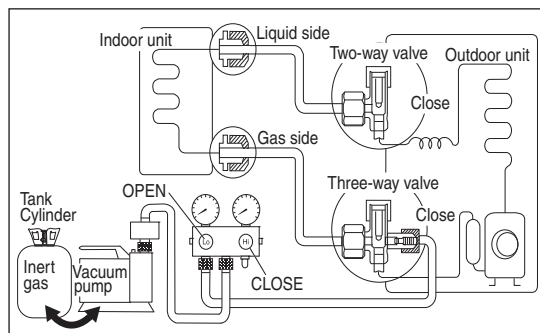

- 14 Disconnect the charging hose from the service port of the 3-way valve.
- 15 Tighten the service port caps of the 3-way valve at a torque of 18 N•m with a torque wrench.
- 16 Remove the valve caps of both of the 2-way valve and 3-way valve.
- 17 Open both of the valves, using a hexagonal wrench (4mm).
- 18 Mount back the valve caps onto the 2-way valve and the 3-way valve to complete this process.

#### Notes:

Recommended use of any of the following leak detector,

- I) Universal Sniffer leak detector
- II) Electronic halogen leak detector
- III) Ultrasonic Leak Detector

### 12.3.4 Connect the Cable to the Outdoor Unit

- 1 Remove the control board cover from the unit by loosening the screw.
- 2 **Connection cable** between indoor unit and outdoor unit shall be approved polychloroprene sheathed 4 x 1.5 mm<sup>2</sup> (3/4 ~ 1.75HP) or 4 x 2.5 mm<sup>2</sup> (2.0 ~ 2.5HP) flexible cord, type designation 60245 IEC 57 or heavier cord. Do not use joint connection cable. Replace the wire if the existing wire (from concealed wiring, or otherwise) is too short.

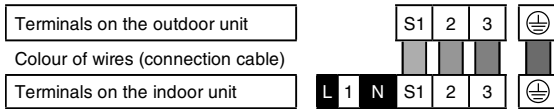

- 3 Secure the cable onto the control board with the holder (clammer).
- 4 Attach the control board cover back to the original position with screw.
- 5 For wire stripping and connection requirement, refer to instruction 12.2.4 of indoor unit.

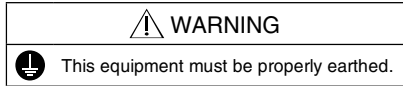

- Earth wire shall be Yellow/Green (Y/G) in colour and longer than other AC wires for safety reason.

### 12.3.5 Piping Insulation

- 1 Please carry out insulation at pipe connection portion as mentioned in Indoor/Outdoor Unit Installation Diagram. Please wrap the insulated piping end to prevent water from going inside the piping.
- 2 If drain hose or connecting piping is in the room (where dew may form), please increase the insulation by using POLY-E FOAM with thickness 6 mm or above.

### 12.3.6 Disposal of Outdoor Unit Drain Water

- If a drain elbow is used, the unit should be placed on a stand which is taller than 3 cm.
- If the unit is used in an area where temperature falls below 0°C for 2 or 3 days in succession, it is recommended not to use a drain elbow, for the drain water freezes and the fan will not rotate.

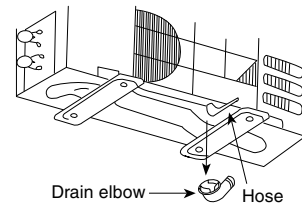

Install the hose at an angle so that the water smoothly flows out.

### 12.3.7 In case of Reusing Existing Refrigerant Piping

- Observe the followings to decide reusing the existing refrigerant piping. Poor refrigerant piping could result in product failure.
- In the circumstances listed below, do not reuse any refrigerant piping. Instead, make sure to install a new piping.
  - Heat insulation is not provided for either liquid-side or gas-side piping or both.
  - The existing refrigerant pipe has been left in an open condition.
  - The diameter and thickness of the existing refrigerant piping does not meet the requirement.
  - The piping length and elevation does not meet the requirement.
- Perform proper pump down before reuse piping.
- In the circumstances listed below, clean it thoroughly before reuse.
  - Pump down operation cannot be performed for the existing air-conditioner.
  - The compressor has a failure history.
  - Oil color is darken. ( ASTM 4.0 and above ).
  - The existing air-conditioner is gas/oil heat pump type.
- Do not reuse the flare to prevent gas leak. Make sure to install a new flare.
- If there is a welded part on the existing refrigerant piping, conduct a gas leak check on the welded part.
- Replace deteriorated heat insulating material with a new one. Heat insulating material is required for both liquid-side and gas-side piping.

### 12.3.8 Proper Pump Down Method

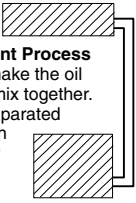
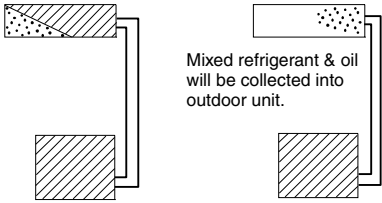
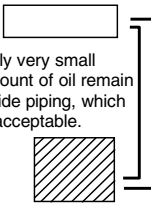
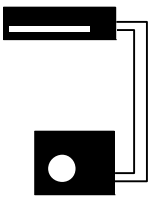
<p>① Operate air conditioner at cooling mode for 10~15 minutes.</p>	<p>② After 10~15 minutes of pre operation, close 2 way valve. After 3 minutes, close 3 way valve.</p>	<p>③ Take out air conditioner unit.</p>	<p>④ Install New Refrigerant air conditioner.</p>
<p><b>Most Important Process</b> Purpose: To make the oil &amp; refrigerant mix together. They are in separated condition when air conditioner is stopped.</p> 	<p>Mixed refrigerant &amp; oil will be collected into outdoor unit.</p> 	<p>Only very small amount of oil remain inside piping, which is acceptable.</p> 	

## 13. Installation and Servicing Air Conditioner using R32

### 13.1 About R32 Refrigerant

For air conditioning refrigerants such as R410A, the refrigerants were collected back in order to prevent their air dissipation, to curbe the global warming impact, in case they were released into the atmosphere. In the “4th Environmental Basic Plan”, 80% reduction of greenhouse gas emissions by 2050 is required, and due to this requirement, further reduction in the emission of high greenhouse effect gas, such as CFCs, is required. Therefore, the conversion of air conditioning refrigerant into the ones who has smaller greenhouse effect, even if it is dissipated into the atmosphere, became our responsibility.

Nevertheless, in case of air conditioning refrigerant, it would be the best if there is a refrigerant which has smaller impact on global warming, but ensures good energy efficiency and performance, and is safe; however, there is no such refrigerant which satisfies all these conditions. As a result, we have been considering the practical usage, within the safety frame-work, of R32 refrigerant which has short lifetime in the atmosphere, and has smaller effect of global warming, but is slightly flammable.

In 2004, due to the revision of air conditioner safety standards by the International Electro-safety Commission (IEC), the safety standards of air conditioners using slightly flammable refrigerant was issued. In 2010, the regulations of American Society of Heating, Refrigerating and Air-Conditioning Engineers in the United States (ANSI/ASHRAE34) was issued adopting the grades for refrigerants which are difficult to inflame due to their slow burning rates, and as a result have smaller damages in cases of fire. The burning rate of R32 is lower by 10cm / per second, and safety standardization for various usage is now being processed.

### 13.2 Characteristics of R32 Refrigerant

#### 1. Chemical Characteristics

R32 is one of the refrigerants used in R410A, has almost no toxicity, and chemically stable compound formed by hydrogen, carbon and fluorine.

R32 has short lifetime of 4 to 9 years in case of being released into the atmosphere; therefore, it has smaller greenhouse gas effect but has slight inflammability because of the large proportion of hydrogen.

Chemical Characteristic Table of R32, R410A and R22.

	R32	R410A	R22
Chemical Formula	CH <sub>2</sub> F <sub>2</sub>	CH <sub>2</sub> F <sub>2</sub> / CHF <sub>2</sub> CF <sub>3</sub>	CH <sub>2</sub> ClF
Composition (mixture ratio wt.%)	Single Composition	R32 / R125A (50 / 50 wt.%)	Single Composition
Boiling Point (°C)	-51.7	-51.5	-40.8
Pressure (physical) *1	3.14	3.07	1.94
Capacity (physical) *2	160	141	100
COP (physical) *3	95	91	100
Ozone Depletion Potential (ODP)	0	0	0.055
Global Warming Potential (GWP) *4	675	2090	1810
Inflammability *5	Slightly Inflammable (A2L)	Non-inflammable (A1)	Non-inflammable (A1)
Toxicity	None	None	None

\*1 : Physical property of temperature condition 50°C

\*2 : Relative value of temperature condition 0/50°C, providing R22=100

\*3 : Te/Tc/SC/SH=5/50/3/0°C

\*4 : GWP=Global Warming Potential, each figure is based on “4<sup>th</sup> IPCC4 Report”

\*5 : Based on ANSI / ASHRAE std. 34-2010

## 2. Characteristic of Pressure

As shown in Table 2, R32 does not have much difference in vapor pressure at the same refrigerant temperature comparing to R410A, but comparing to R22, it is higher at 1.6 times more. Thus, the same as in case of R410A, it is necessary to do installation and service using high-pressure tools and components.

Table 2. Saturated vapor pressure comparison table

(Unit: MPa)

Temperature	Refrigerant		
	R32	R410A	R22
-20	0.30	0.30	0.14
0	0.71	0.70	0.40
20	1.37	1.35	0.81
40	2.38	2.32	1.43
60	3.84	3.73	2.33
65	4.29	4.17	2.60

Reference : Thermal properties table of Japan Society of Refrigerating and Air Conditioning Engineers (60, 65°C)  
NIST REFPROP V8.0 (-20 ~ 40°C)

## 13.3 Refrigerant piping installation • Tools used in services

### 13.3.1 Required Tools

R32 refrigerant air conditioners use the common parts as R410A air conditioners for two-way valves and three-way valves (diameters of service ports); thus, they maintain commonality in the maintenance of the compressive strength, the size of pipe flaring, and the size of flare nuts as R410A. Therefore, for refrigerant pipe installation and services, you can use tools for R410A.

However, mixing of refrigerants is not allowed, so that you have to separate the cylinders for the recovery of refrigerants.

Tools used for installation • relocation • replacement of air conditioning units

Works	R32	R410A	R22
Flaring	Flare tools for R410A (clutch type)		Flare tools for R22 (clutch type)
Connection of pipes	Torque wrench (diameter 1/4 3/8)		
	Torque wrench (diameter 1/2 5/8) *1		Toque wrench (diameter 1/2 5/8)
Manifold gauge charging hose	R32 & R410A Common (As at November 2013)		R22 Only
Air purging	Vacuum pump + Reducer / expander		Vacuum pump
Gas leakage test	Detection liquid or soup water, HFC detector		

\*1. Nut diameters of 1/2 5/8, the size of torque wrench common with R410A

For other installation, you can use general tools such as screw drivers (+, -), metal saws, electric drills, long-nose pliers, hole core drills (ø70 or ø65), linen tape, levels, temperature gauges, clamp meters, electric knives, nippers, pipe cutters, reamers or scrapers, spring benders, (diameters 1/4 3/8 1/2 5/8), monkey wrenches, fixing wrenches (17 or 12 mm), feeler gauges, hexagon wrenches (4 mm), testers, megohm testers, etc.

Tools used for services

Works	R32	R410A	R22
Insertion of refrigerant	Digital scale for refrigerant charging, refrigerant cylinders, cylinder adopters and packing *a		
Recovery of refrigerant	Refrigerant recovery devices, refrigerant cylinders, manifold gauges, charging hoses *b		

\*a. Use cylinder for each refrigerant, cylinder adopter and packing.

\*b. Use refrigerant recovery cylinder separately for each refrigerant (**no mixture of refrigerant allowed**). Please be aware that there are some refrigerant collection devices which do not have self-certification.

### 13.3.2 Tools for R32 (common with R410A)

#### 1. Flare gauges

Use flare gauges when you perform flaring with flare tools (crutch type). Flare gauges are used to set the pipe ends at 0.5 ~ 1.5 mm from clump bars of flare tools.

Flare gauges



#### 2. Flare tools (clutch type)

Flare tools have larger holes of clump bars in order to set the pipe end at 0 ~ 0.5 mm, and have stronger springs inside to ensure solid flaring torques. These flare tools can be used commonly for R22.

Flare tools (clutch type)



### 3. Torque wrenches (diameters 1/2, 5/8)

In order to strengthen the compressive strength, the diameters of wrenches change depending on the flare nut sizes.

#### Torque wrenches

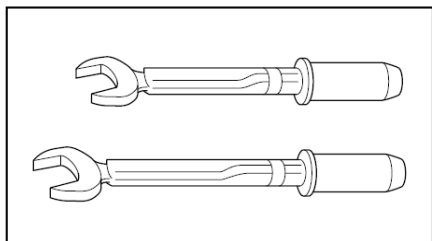

#### Differences in torque wrenches

	R32 (common R410A)	R22
1/2 (diameter × torque)	26 mm × 55 N•m (550 kgf•cm)	24 mm × 55 N•m (550 kgf•cm)
5/8 (diameter × torque)	29 mm × 65 N•m (650 kgf•cm)	27 mm × 65 N•m (650 kgf•cm)

### 4. Manifold gauges

R22 gauges cannot be used because of the high pressures.

Each port of manifold has different shapes in order to prevent inserting wrong refrigerant.

\*However, the port shape for R410A and R32 is the same; therefore, attention need to be paid not to insert wrong refrigerant.

#### Differences in high/low pressure gauges

	R32 (common R410A)	R22
High pressure gauges (red)	-0.1 ~ 5.3 MPa -76 cmHg ~ 53 kgf / cm <sup>2</sup>	-76 cmHg ~ 35 kgf / cm <sup>2</sup>
Low pressure gauges (blue)	-0.1 ~ 3.8 MPa -76 cmHg ~ 38 kgf / cm <sup>2</sup>	-76 cmHg ~ 17 kgf / cm <sup>2</sup>

#### Difference in manifold port sizes

	R32 (common R410A)	R22
Port sizes	1/2 UNF20	7/16 UNF20

### 5. Charging hoses

The pressure resistance of charge hoses is increased. At the same time, the material is changed to HFC resistant, and the size of each manifold adopter is changed, as the port size of manifold gauge itself. Further, some hoses are with anti-gas pressure backflow valves placed near the adopters. (hoses with the valves recommended)

### Manifold gauges / Charging hoses



#### Differences in charging hoses

		R32 (common R410A)	R22
Pressure Resistance	Normal operation pressure	5.1 MPa (52 kgf / cm <sup>2</sup> )	3.4 MPa (35 kgf / cm <sup>2</sup> )
	Burst pressure	27.4 MPa (280 kgf / cm <sup>2</sup> )	17.2 MPa (175 kgf / cm <sup>2</sup> )
Material		HNBR rubber Internal nylon coating	NBR rubber

### 6. Vacuum pump and Vacuum pump adopter

When using a vacuum pump, it is necessary to set a solenoid valve in order to prevent backflow of vacuum pump oil into the charge hoses, and use a vacuum pump with oil backflow prevention function, or use the vacuum pump with vacuum pump adopter.

If vacuum pump oil ( mineral oil-based ) mixes with R410A (R32), it may cause damage to the machine.

#### Vacuum pump



#### Vacuum pump adopter



7. HFC refrigerant\_Electric gas leakage tester  
 R32 refrigerant is often used for other mixed refrigerant (R410A, R404A, R407C etc.). Therefore, the usage of existing HFC detectors is possible, but in order to detect more accurately, we recommend to use detectors specially set and adjusted for R32 detection.

HFC refrigerant\_Electric gas leakage tester



8. Digital scale for refrigerant charging  
 R32 and R410A have high pressure level and their evaporation speed is high. Thus, if you recover the refrigerant by cylinder charging method, the refrigerant evaporates within the weighing scale glass, which makes reading the scale difficult, rather than liquidating the refrigerant into the cylinder. (Charging cylinders for R22 have different pressure resistance, scale, connection port size; therefore, they are not usable) At the same time, the digital scale for refrigerant charging is strengthened by receiving the weight of the refrigerant cylinders with four pillars at the corners. The connection ports of charging hoses have two separate ports for R22 (7/16 UNF20) and R32/R410A (1/2 UNF20) therefore, they can be used for the insertion of the existing refrigerants.

Digital scale for refrigerant charging



9. Refrigerant cylinders  
 Refrigerant cylinders for R410A are painted in pink, and the ones for R32 are painted in other colors that might subject to change according to the international standards. R32 is a single refrigerant, so that both liquid and gas insertion are possible. Additional charging is also possible. (R410A is a mixed refrigerant, so only liquid insertion is possible)

Refrigerant cylinders



10. Connection ports of refrigerant cylinders and packing  
 Charging ports which fit to the charging hose connection port size (1/2 UNF20) is needed. At the same time, the packing has to be of HFC resistant materials.

Connection ports and packing



## 11. Tools used for refrigerant piping installations and services

	Tools for R410A	Common with R32	Possibility of usage for R22
1.	Pipe cutters, reamers or scrapers	○	○
2.	Flare tools (clutch type)	○	○
3.	Torque wrench (1/4, 3/8)	○	○
4.	Torque wrench (1/2, 5/8)	○	×
5.	Manifold gauges · charging hoses	○	×
6.	Vacuum pumps, vacuum pump adopters	○ Connection 5/16	○ Connection 1/4
7.	Electric gas leakage testers for HFC *1	○	△
8.	Digital scale for refrigerant charging	○	○
9.	HCF recovery devices (connection port 5/16) *2	○ Connection 5/16	○ Connection 1/4
10.	Refrigerant cylinders (pressure resistant: FC3)	Same specs ×	×
11.	Refrigerant cylinders (pink)	Other (colors that might subject to change according to the international standards).	×
12.	Refrigerant cylinder connection ports and packing	○	×
13.	Allen wrench (4 mm) Electric knives	○	○
*1	Those testers only for HCFC22 (R22), but not for HCF32 (R32) and HCF410A (R410A) cannot be for common use.		
*2	Recovery devices which are self-certified for each HCF type can be used.		
	<p>[Knowledge for the common usage of tools for R410A &amp; R32]</p> <ul style="list-style-type: none"> <li>• R410A and R32 machines use different compressor oils.</li> <li>• If unregulated compressor oil gets mixed into, it may cause damage to the machine function.</li> <li>• Careful pump down will ensure the recovery of compressor oil, and it will minimize the remaining amount of the oil in the manifold gauge and charging hose.</li> <li>• If you only perform the recovery of refrigerant and not be able to perform pump down, <u>you have to dispose the compressor oil in the charging hose.</u></li> </ul>		
	<p>[Precaution of repairing refrigerant cycle]</p> <ul style="list-style-type: none"> <li>• In the brazing, open 2-way and 3-way valves, and make sure the refrigerant is completely recovered back and not remaining the system.</li> <li>• When repairing outside, make sure no refrigerant is in the air, ensure good air flow, and perform the brazing.</li> </ul>		
	<p>[Inserting wrong refrigerant]</p> <ul style="list-style-type: none"> <li>• It may cause “not cooling” and “not heating” customer claims because each component (expansion valve, compressor, PCB) of the refrigeration cycle is specially adjusted for R32.</li> <li>• At the same time, it is not subject to product warranty, if wrong refrigerant was inserted into the system.</li> </ul>		

### 13.4 New installation, Relocation, Repairing of Refrigerant Cycle System The Procedures

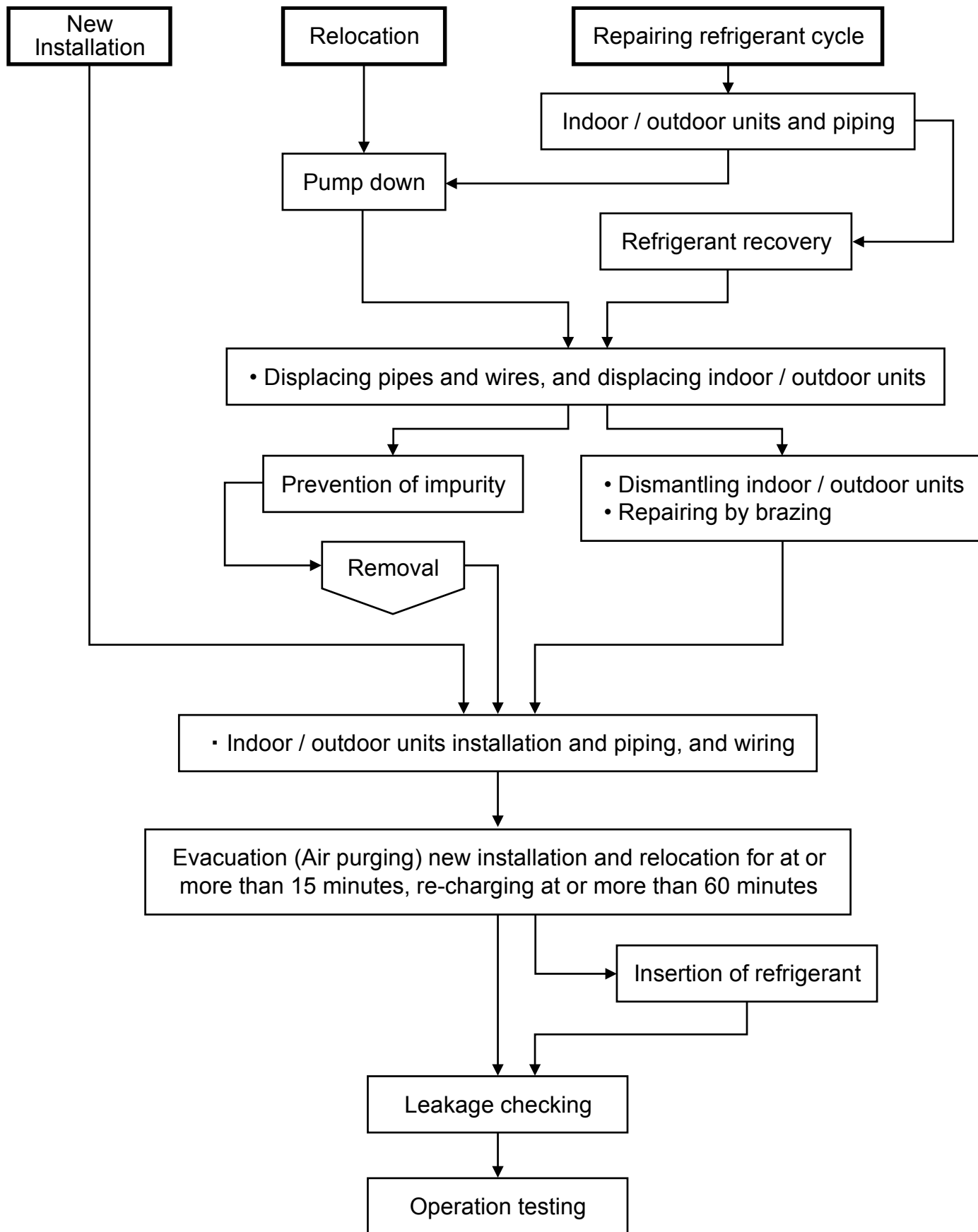

## 13.5 Piping installation of R32

### 13.5.1 Pipe materials used and flaring

Copper pipes are used for refrigerant piping. Pipes which comply with JIS Regulations need to be used. Room air conditioners which use R410A and R32 have higher pressure; thus, using pipes which comply with the Regulations is important.

The pipe thickness is regulated by revised JIS B 8607 "Flaring and brazing fittings for refrigerant" and the pipe thickness for R410A, R32 is shown in the table.

Pipe thickness

O and OL materials		Thickness (mm)		
Diameter	Diameter (mm)	R410A	R32	R22
1/4	6.35	0.80		
3/8	9.52	0.80		
1/2	12.70	0.80		
5/8	15.88	1.00		

#### Caution

- For connection piping, use copper phosphate seamless pipes (1220T) as regulated in "JIS H 3300" and the pipe thickness is 0.8 mm.
- In the market, there are some pipes of 0.7 mm thickness, but do not use these pipes (0.8 mm thickness has to be strictly followed).
- It is recommended to use pipes whose adhesion amount of oil is at or less than 40 mg / 10 m. At the same time, do not use pipes with dent, de-shape, and color change (especially inside).

### 13.5.2 Processing and connection of pipes

For refrigerant pipe installation, be aware of moisture and dirt do not get into the pipes, and make sure of no refrigerant leakage.

◎ The procedure of flaring and precautions

- Cutting of pipes : use pipe cutter and cut the pipe slowly not to de-shape the pipe.
- Removal of burrs on the edge of pipe (reamer or scraper)  
If the condition of pipe edge after the deburring is no good or if burrs attaches on the flaring, it may cause refrigerant leakage. Turn the pipe end down and perform deburring carefully.
- Insert the flare nut (use the nut which is a part of the CZ parts)
- Flaring

Ensure the cleanliness of clump bar and pipe, and perform flaring carefully.

Use the existing flare tools or flare tools for R410A. Be aware that the sizes and dimensions of flaring is different in each flaring tool. If you use the existing flaring tools, use flaring gauge to measure the length of the flaring part.

Piping size (mm)	Dimensions "a" (mm) R22			Dimensions "a" (mm) R410A/R32		
	Flare tools		Flare tools for R410A	Flare tools		Flare tools for R410A
	Clutch type	Wing nut type	Clutch type	Clutch type	Wing nut type	Clutch type
6.35 (1/4")	0.5 ~ 1.0	1.0 ~ 1.5	0 ~ 0.5	1.0 ~ 1.5	1.5 ~ 2.0	0 ~ 0.5
9.52 (3/8")	0.5 ~ 1.0	1.0 ~ 1.5	0 ~ 0.5	1.0 ~ 1.5	1.5 ~ 2.0	0 ~ 0.5
12.70 (1/2")	0.5 ~ 1.0	1.5 ~ 2.0	0 ~ 0.5	1.0 ~ 1.5	2.0 ~ 2.5	0 ~ 0.5
15.88 (5/8")	0.5 ~ 1.0	1.5 ~ 2.0	0 ~ 0.5	1.0 ~ 1.5	2.0 ~ 2.5	0 ~ 0.5

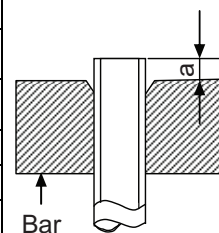

Nut outer diameter (mm)	
R22	R410A
	R32
17	17
22	22
24	26
27	29

## 13.6 Installation, Relocation, and Service

### 13.6.1 Air purge and gas leak test for new installation (using new refrigerant pipes) using vacuum pump

(From the point of view of global environment protection, do not release CFCs into the atmosphere during installation work)

1. Connect the charging hose of manifold gauge to the service port of 3-way valve (pushing insect pin).
2. Fully open the handle Lo of manifold gauge and operate vacuum pump.  
(If the needle of the low-pressure gauge reaches the vacuum immediately, check 1 procedure again)
3. Perform vacuuming 15 minutes or more, and make sure low pressure gauge reaches to  $-0.1\text{ MPa}$  ( $-76\text{cmHg}$ ).  
When the vacuuming completes, fully open the handle Lo of manifold gauge and stop the operation of vacuum pump, and leave it for 1 ~ 2 minutes. Then, remove the connection side of the charging hose of vacuum pump adaptor after checking the needle of manifold gauge does not turn back.
4. Open the stem of 2-way valve to  $90^\circ$  in anti-clock wise, and close the 2-way valve after 10 seconds, and perform gas leakage test.
5. Remove the charge hose from the service port of 3-way valve, and open the stems of 2-way and 3-way valves (open the valves to anti-clock wise carefully, do not use full strength to open)
6. Tighten the service port cap with torque wrench  $18\text{ N}\cdot\text{m}$  ( $1.8\text{ kgf}\cdot\text{m}$ )  
Tighten the caps of 2-way and 3-way valves with torque wrench  $18\text{ N}\cdot\text{m}$  ( $1.8\text{ kgf}\cdot\text{m}$ )
7. After the tightening of each cap, check gas leakage around the cap.

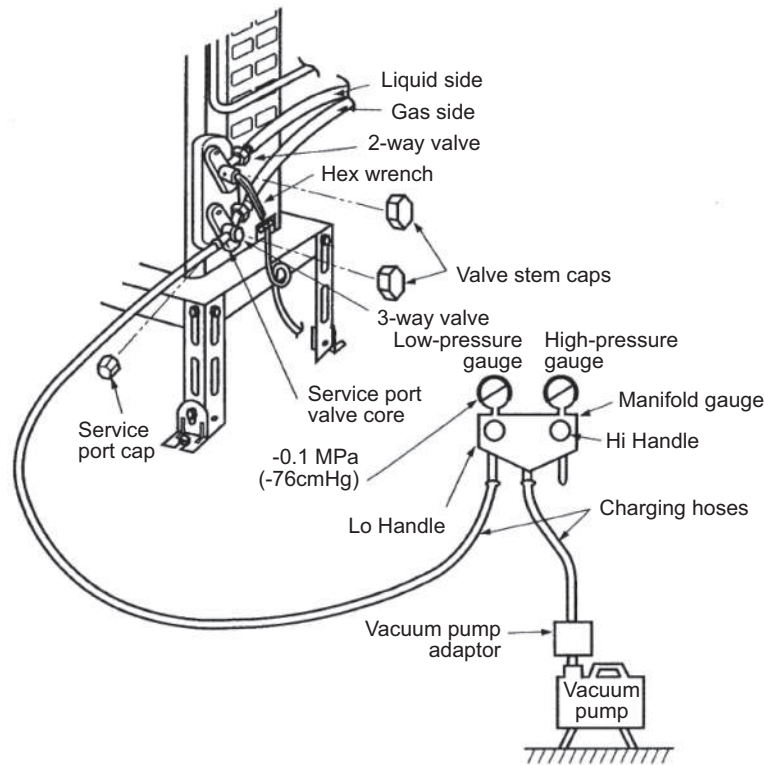

### 13.6.2 Process of refrigerant recovery

1. Connect the center charging hose of manifold gauge to the in-let side of recovery device.
2. Connect the valves of the discharge side of recovery device and liquid side of refrigerant cylinder with red hose (charging hose).
3. Connect the yellow float switch cable of the recovery device to the refrigerant cylinder.
4. Open the low pressure side valve of manifold gauge.
5. Insert electric plug of recovery device into electrical outlet (the fan operation starts).
6. Turn the valve 1 and 2 of recovery device to pressure equalization point.
7. After a few seconds, turn back the valve 1 and 2 to the original position.
8. Turn the switch of the recovery device to "ON". (the compressor operation starts)
9. When the low pressure of manifold gauge is close to "0", close the low pressure side valve, turn "OFF" the recovery device switch.
10. Remove the center charging hose of manifold gauge from the recovery device.

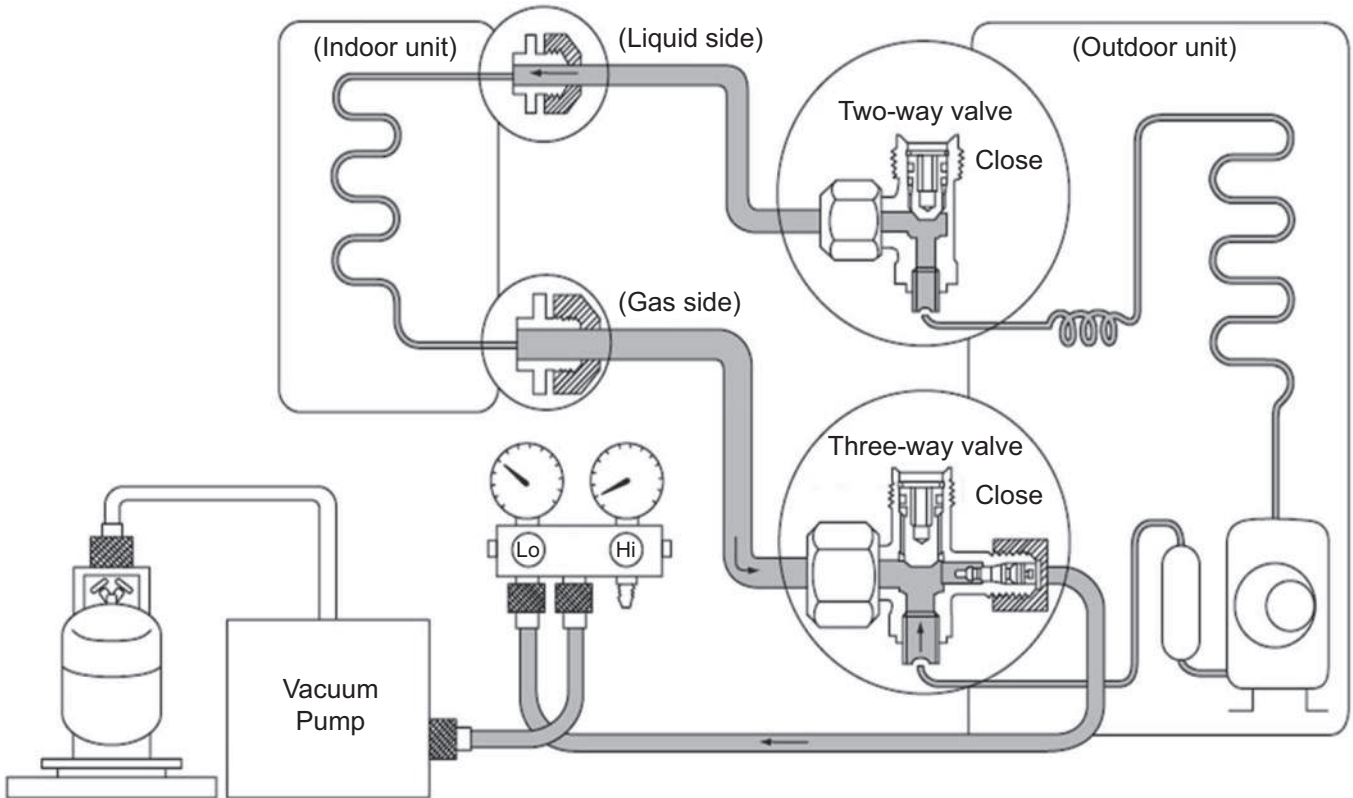

### 13.6.3 Relocation

#### 1. Removing the air conditioning unit

##### a) Recovery of outdoor unit refrigerant by pumping down

Press “forced cooling button” (as a general rule, since 1998 the name of cooling testing button is changed, and this name is unified within the air conditioning industry), and then you are able to start cooling operation in which the room temperature is low, and you can recover the refrigerant from the outdoor unit.

1. Check the valve stems of two-way and three-way valves are open by being turned to anti-clockwise (Remove the caps, and confirm the bars are fully open. Use hexagon wrench <4 mm> to open and close the valves).
2. Press the “Emergency Operation” button of the indoor units for five seconds and release [Forced cooling operation] (for old models, press “forced cooling” button). Then, operate the air conditioning unit for about 10 minutes.
3. Turn the stem of the two-way valve to the clock-wise and close the valve.
4. After about 2 ~ 3 minutes, turn the stem of the three-way valve quickly to the clock-wise, and stop the operation.

**Caution:** In the pump down operation, stop the compressor before removing the refrigerant pipes.

If you do not stop the compressor operation, and if the valve is open and remove the refrigerant pipes, the air may be sucked into the system and causes extreme high temperature in the refrigerant cycle. This may result in rupture or injury, etc.

5. Attach and tighten the caps of two-way and three-way valves with torque wrench.
6. Remove the connecting pipes (liquid side and gas side).

##### b) Removal of indoor and outdoor units

1. Remove the connecting pipes and wires between the indoor and outdoor units.
2. Attach capping flare nuts on the edges of the pipes, connecting the indoor and outdoor units, in order to prevent dust and moisture get into the pipes.
3. Remove the indoor and outdoor units.

#### 2. Unit installation

Use new refrigerant pipes for the installation, and perform air purging using vacuum pump and gas leakage testing stated in 14.5.1.

### 13.6.4 Replacement of air conditioning units and evacuation (when re-using the existing pipes)

When replacing the air conditioning units, you might use the existing pipes, but it is recommended to perform flaring again. In case of unit replacement, even if the unit is new refrigerant air conditioner, if the refrigerant oil is different, it may cause problem. Further, when re-using the existing refrigerant pipes, it is recommended to evacuate the pipes as much as possible, due to the reason that much refrigerant oil may be attached on the surface of the pipes. If the pipes are used without evacuation, the remaining refrigerant oil may cause under-performance and abnormal refrigerant cycle caused by non-compatibility of those oils.

### 13.6.5 Inter-changeability of refrigerant

Do not operate air conditioning units inserting wrong (or mixed) refrigerant (R22, R410A, R32). It may cause malfunction of the units, and at the same time, may cause serious incident such as rupture of the refrigerant cycle.

### 13.6.6 Re-insertion of refrigerant in service

When re-insertion is needed, follow the procedures to ensure the insertion of new refrigerant at correct amount.

1. Attach charging hose (blue) to the service port of the outdoor unit.
2. Attach charging hose (red) to the vacuum pump. Fully open the 2-way and 3-way valves.
3. Place the refrigerant cylinder on the digital scale for refrigerant charging and connect the charge hose (yellow) to the connection port of the vacuum pump and the digital scale. Leave the cylinder valve fully open.
4. Fully open the handles Lo and Hi of the manifold gauge, and switch on the vacuum pump, and then perform evacuation for at or more than one hour.
5. Confirm the compound gauge of  $-0.1 \text{ MPa}$  ( $-76 \text{ cmHg}$ ) and fully open the handles of Lo and Hi, and switch off the vacuum pump. Leave it for about 1 ~ 2 minutes and confirm the needle of the compound gauge does not turn back.

Refer to the picture below to follow the procedures below.

6. Remove the charging hose (red) of the manifold gauge from the vacuum pump adaptor.
7. After adjusting the digital scale to zero, open the cylinder valve and the valve Lo of the manifold gauge, and insert the refrigerant.
8. If it is not possible to insert the refrigerant at regulated amount at once, operate the cooling mode and gradually insert the refrigerant (recommended amount approx.  $150 \text{ g} / 1 \text{ time}$ )  
\*Do not insert much refrigerant at once.
9. Close the open/close valve and insert the refrigerant in the charging hose to the outdoor unit.  
\*Perform this procedure during operating cooling operation. Close the stem of the two-way valve, and when the pressure of the manifold gauge becomes zero (0), quickly remove the charging hose (blue). Immediately open the 2-way valve, and stop the cooling operation.
10. Final checking ••• Confirm the 2-way and 3-way valves are fully open.

Attach the caps of the service port and control valve, and then check the gas leakage around the caps.

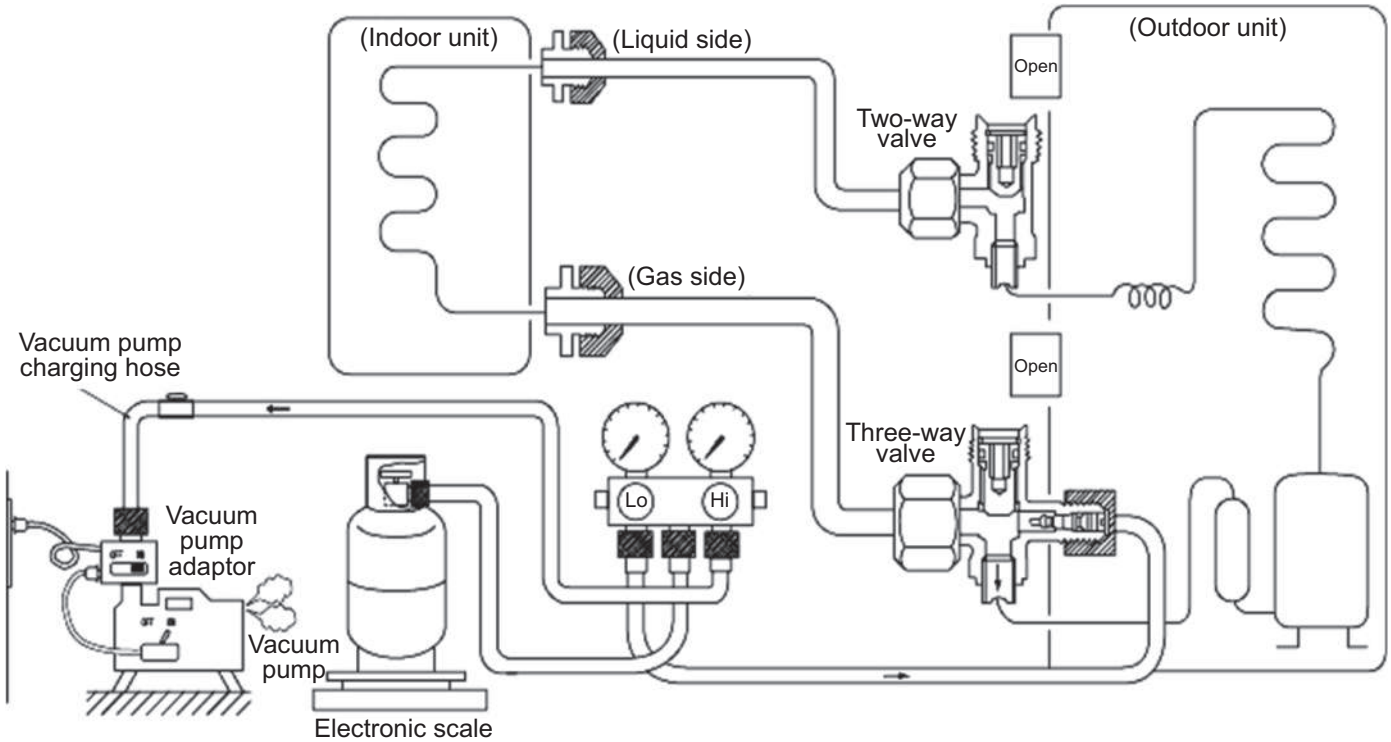

## 13.7 Repairing of refrigerant cycle / Brazing point

### 13.7.1 Preparation for repairing of refrigerant cycle / brazing

Brazing which is a technique needed for repairing refrigerant cycle requires advanced technique and experience, and this brazing procedure can only be performed by the workers who completed "Gas Welding Skill Training" regulated by the Occupational Safety and Health Act, and went through the training programs of refrigerant operations. Dismantling and re-connecting (assembling) refrigerant system requires working space, and the space has to ensure good air flow and fire prevention (water bucket and fire extinguisher). Moreover, the worker has to ensure the wearing of goggles, gloves, safety shoes, and long sleeve shirts, and be aware of work safety and attempt to prevent secondary defect (quality assurance of products). For brazing the indoor / outdoor unit structural components (heat exchangers, compressors, expansion valves, four-way valve blocks), after the recovery of all refrigerant, confirm that no refrigerant remains in the system, and fully open the 2-way and 3-way valves. When the brazing is conducted outside, check and make sure no refrigerant is contained in the air (be careful with vaporized refrigerant). Furthermore, protect the compressor terminal with metal plates, and heat but use wet clothes to cool down (releasing the heat) the expansion valves, and four way valves (prevent destruction of parts). In brazing, it is important to pour the brazing material without melting the base metal based on capillary action principle. In case of holes and oxidizing caused by overheating, do not perform re-brazing or alteration but replace the parts.

### 13.7.2 Adjustment of vacuum pump pressure

#### 1. Cylinder with adjustment handle

1. Check and confirm the adjustment handle of the 1<sup>st</sup> pressure adjuster is loosen (anticlockwise). If cylinder valve is opened when the 1<sup>st</sup> gauge pressure adjust handle is closed, the 2<sup>nd</sup> gauge might get broken.

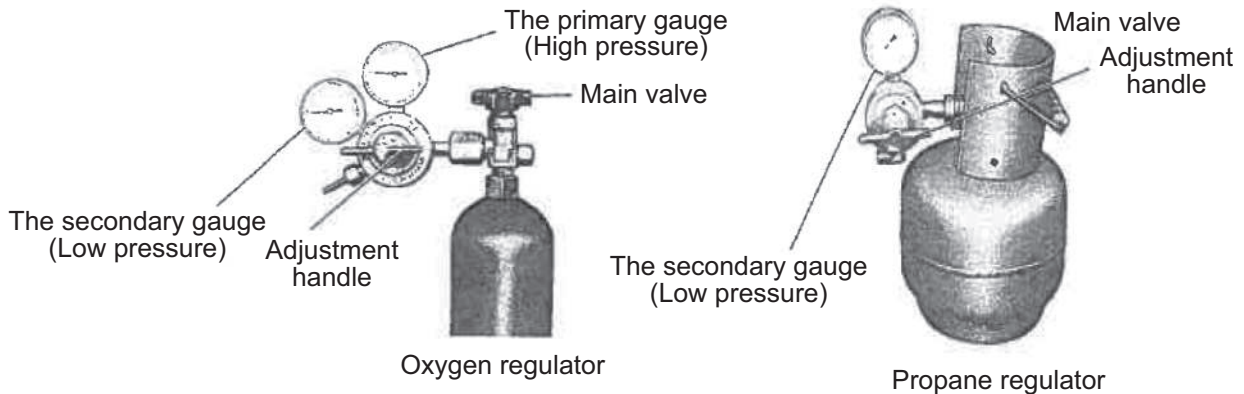

2. Open the cylinder valve, and check the remaining amount with the first t side pressure gauge.
3. Check the pressure of 2<sup>nd</sup> gauge and turn the adjustment handle to clock-wise direction to adjust the pressure.
  - ⊙ Oxygen 2<sup>nd</sup> side gauge pressure . . . . . 0.5 MPa (5.0 kgf / cm<sup>2</sup>)
  - ⊙ Propane 2<sup>nd</sup> side gauge pressure . . . . . 0.05 MPa (0.5 kgf / cm<sup>2</sup>)

2. Cylinder without adjustment valve  
 2<sup>nd</sup> side gauge pressure is adjusted by the adjuster.  
 Check the both side valves of the torch and open the cylinder valve to check the remaining refrigerant in the cylinder.  
 Caution: Do not attach oil component on the connection port of the adjuster.  
 Especially, use an oxygen cylinder adjuster which is no oil substance type. Do not dismantle or repair the adjuster and pressure gauge.

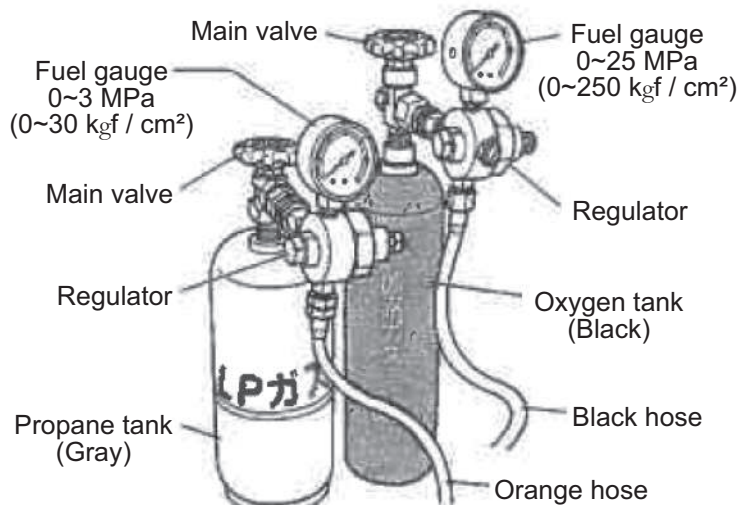

### 13.7.3 Checking of gas provision

Checking there is no fire around the torch, and then confirm the provision of gas.

1. Slightly open the “propane valve” of the torch, and make sure the gas comes out from the torch crater and then close the “propane valve”.
  2. Slightly open the “oxygen valve” of the torch and make sure the gas comes out from the torch crater and then close the “oxygen valve”.
- Check there is no gas leakage around the hose connection.

### 13.7.4 Adjustment of flame

1. Slightly open the “propane valve” of the torch and lit with spark lighter.  
 This moment, the flame is only by propane and the color is red.
2. Gradually open the “oxygen valve” of the torch to mix oxygen, and adjust the amount of propane and oxygen with the valve to make the flame suitable for brazing work.  
 If the white core flame splits into two, the torch crater might be clogged. In this case, remove the crater from the torch and check.

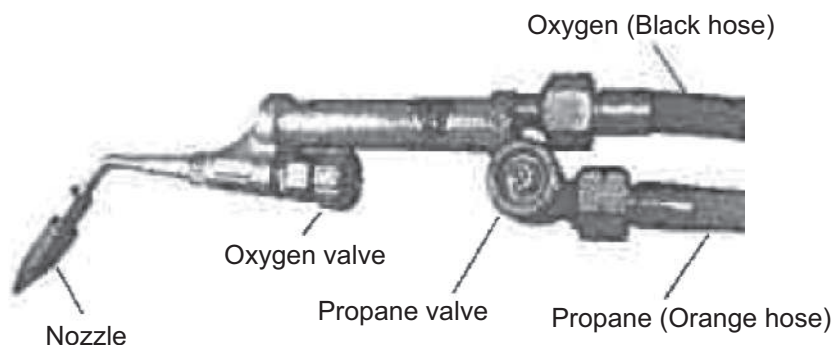

### 13.7.5 Types of flame

Types of flame change based on the proportion of propane and oxygen.

#### [Neutral Flame]

Perform brazing with this flame

(This is a flame when oxygen and propane are mixed at proper proportion, and has lesser effect on the brazed metals)

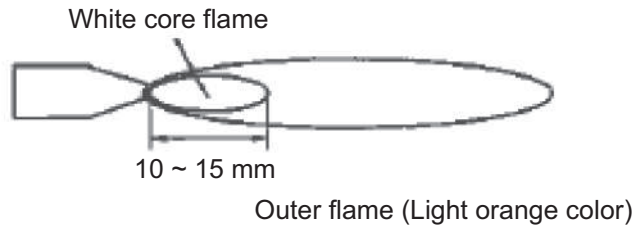

#### [Carbide Flame]

When propane is excessive, the flame has white color flame in between the white core flame and outer flame. (This is due to the lack of oxygen and the proportion of unburned propane is excessive.)

The black carbon created during the brazing work may contaminate the surface of the brazed metal).

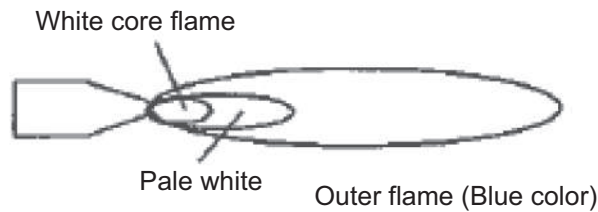

#### [Oxidizing Flame]

Oxygen is more compared to the neutral flame. Although the flame size is small, this has the highest flame heat. However, due to the excessive oxygen contained in the flame, the brazing point gets oxidized. (This flame may cause holes, due to the high heat. The pipe may get melt )

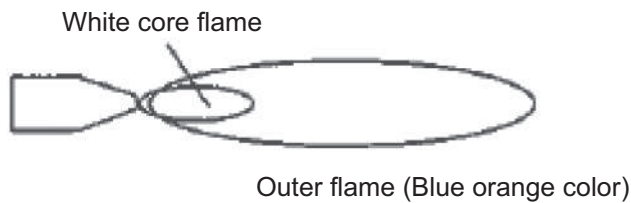

### 13.7.6 Closing the flame

#### [In case of short break]

1. Close the "propane valve" of the torch.
2. Close the "oxygen valve" of the torch.

#### [In case of finishing work]

1. As above, close the flame following the procedure of "In case of short break".
2. Completely close the valves of oxygen and propane cylinders.
3. Release the remaining gas inside the hose by opening the "oxygen valve" and "propane valve" of the torch. Confirm the 1<sup>st</sup> and 2<sup>nd</sup> side gauge pressures of "oxygen" and "propane" cylinder pressure adopter are "zero".

### 13.7.7 Selection of brazing material

Use BAg brazing material (silver solder) to increase the welding performance.

Category	JIS Standard Number	Composition of ingredients (%)						Temperature (°C)			Tensile strength (Reference)		Characteristics and applications
		Ag	Cu	Zu	Cd	Ni	P	Solidus	Liquidus	Brazing temp	Kgf·cm <sup>2</sup>	Base material	
BAg	BAg • 1A	49.0 ~ 51.0	14.5 ~ 16.5	14.5 ~ 18.5	17.0 ~ 19.0	—	—	approx. 625	approx. 635	635 ~ 760	45.5	S20C	Liquidity is good at low temperature, it is preferable to a small junction of the gap in the universal form.
	BAg • 1	44.0 ~ 56.0	14.0 ~ 16.0	14.0 ~ 18.0	23.0 ~ 25.0	—	—	approx. 605	approx. 620	620 ~ 760	45.5	S20C	It has similar performance to the BAg • 1A, and suitable for every base material except the light weight metal.
	BAg • 2	34.0 ~ 36.0	25.0 ~ 27.0	19.0 ~ 23.0	17.0 ~ 19.0	—	—	approx. 605	approx. 700	700 ~ 845	45.5	S20C	It is a brazing filler metal in universal form, suitable for a slightly larger gap junction.
	BAg • 3	48.0 ~ 51.0	14.5 ~ 16.5	13.5 ~ 17.5	15.0 ~ 17.0	2.5 ~ 3.5	—	approx. 630	approx. 690	690 ~ 815	35 ~ 70	SS ~ SUS	It has good corrosion resistance in stainless steel-based brazing, suitable for brazing tungsten carbide, aluminum bronze and copper.
BCuP	BCuP-2	—	remain	—	—	—	6.8 ~ 7.5	approx. 710	approx. 785	690 ~ 815	21 ~ 24.5	Cu	Good liquidity, suitable for brazing copper tube.
	BCuP-3	4.8 ~ 5.2	remain	—	—	—	5.8 ~ 6.7	approx. 645	approx. 815	720 ~ 815	21 ~ 24.5	Cu	Suitable for brazing when the joint spacing is not constant
	BCuP-5	14.5 ~ 15.5	remain	—	—	—	4.8 ~ 5.3	approx. 645	approx. 800	705 ~ 815	21 ~ 24.5	Cu	When brazing of copper and copper, it is used without a flux, but not possible for brazing basic materials

#### Caution

BCuP (phosphorus copper wax) is easy to react with sulfur, and makes a brittle compound water soluble, and causes gas leakage. In hot spring areas, use other brazing materials or paint the surface for protection.

### 13.7.8 Need of flux

Use flux to protect the base materials.

1. Remove impurity and oxide film on the metal base, and improve the flow of the brazing material.
2. Prevent oxidation of the metal surface in brazing.
3. Reduce the surface tension of the brazing material.

### 13.7.9 Need of nitrogen gas

In order to prevent oxidation in the pipe, perform the brazing operation in nitrogen gas flow. Flow rate 0.05 m<sup>3</sup> / h, or pressure reducing valve at 0.02 MPa (0.2kgf / cm<sup>2</sup>) below.

### 13.7.10 Checking of brazing (insert) points

1. No impurity on the brazing point  
If dirt or oil is attached on the brazing point, the brazing filler metal does not reach to junction, and it may cause poor welding.
2. Adequate gap space in the brazing point  
The advantage of capillary current situation is used in brazing. If the gap space is too large, this phenomenon may not occur and it may cause poor welding because brazing filler metal does not flow to join the front part.
3. Appropriate size for insertion  
The guideline for pipe insertion dimensions is to three times the diameter of the base material, but you need to decide the insertion size in consideration of the clogging of the brazing material. Generally, for thin pipes, you need to increase the insert size, and for thick pipe vice versa.

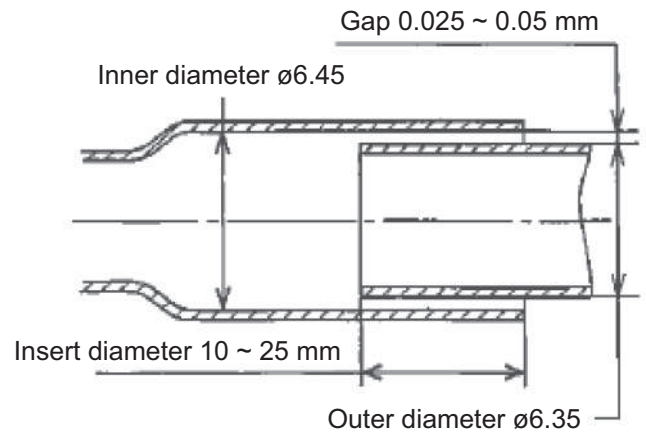

4. Brazing material to flow from top to bottom  
Brazing filler metal will easily flow to the connecting portion by capillary action. Further, by bending the brazing portion of [dryer side] of the capillary tube at 120°, you can prevent the damage of dryer inside and the clogging of brazing material caused by the excessive insertion of capillary tube.

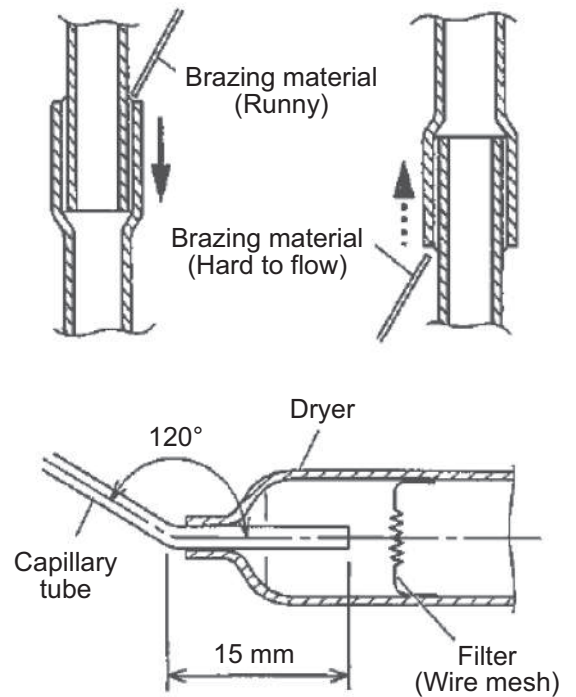

### 13.7.11 Brazing and heating

1. Place the flame to a pipe which has more heat capacity in order to let the brazing material melt by the pipe heat. Heat the pipe up to the melting temperature of the brazing material, but when it is overheating, assess the temperature by pipe color in order not to melt the pipe.

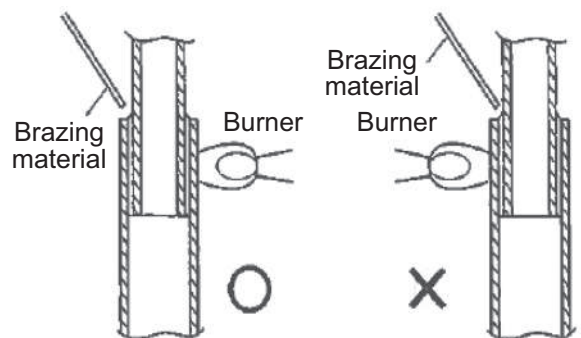

The pre-heating is to heat the base material until the melting temperature, and requires certain training to distinguish the color of the heated base material in order not to melt the material.

The color and temperature of copper tube

- Becoming red color ..... 480°C
- Dull red ..... 650°C
- Cherish red ..... 760°C
- Brightening cherish red ..... 870°C

(Reference)

Melting temperature of copper ••••••• Approx. 1083°C

Maximum temperature obtained in propane and oxygen ••••••• Approx. 1083°C

The important point is to heat the bonding part uniformly within a short period of time until reaching to the brazing temperature in the following manner.

2. Apply the flame on to the side with better heat transmission. If the pipe thickness is consistent, by heating like 30% iron and 70% copper, the copper pipe inside reaches to brazing temperature. Iron pipes have low heat transmission and only the part the flame is applied get high temperature, and this causes oxidization of the pipe. The flow of the brazing filler is affected negatively.

3. Apply the flame on to the side of larger heat capacity.

When brazing a thin tubes such as capillary tube and dryer, etc., caution has to be taken to apply the flame to the dryer side (thick pipe side), in order to prevent burn out by the heat.

4. When brazing the compressor connection pipes (suction and discharge), remove the sound insulation plate and the fan, and place the compressor stand vertically (to prevent the leakage of compressor refrigerating machine oil), and apply the flame from the compressor body side.

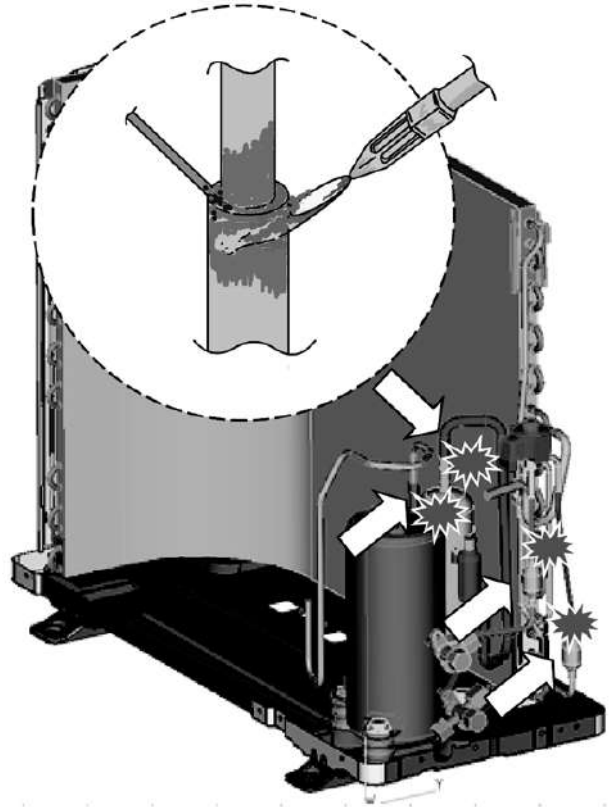

### 13.7.12 Terminologies of brazing

Pin holes → Small holes are generated on the surface of the brazing metal.

Wet temperature → Liquidus temperature at which the brazing material starts flowing out by heating, generally it is the liquidus-line temperature.

Blow holes → Hollows made by gas in the brazing material of brazing portion (gas reservoirs).

Pits → As a result of blow holes, small dents generated on the outside surface of welding.

Voids → The brazing material does not reach completely to the brazing part. It cannot be identified from outside.

## 13.8 <Reference> Analysis method for no error code, no cooling / no warming

### 13.8.1 Preparation for appropriate diagnosis

In order to obtain appropriate operation characteristics, minimum 15 minutes or more operation time [testing operation (rated operation)] is required.

#### 1. Method of rated operation (rated operation)

For the models which have two buttons of “emergency operation and forced cooling operation”, press forced cooling button once. For the models which have only emergency operation button, press the button once for 5 seconds and when hear “beep” sound, release the button. Then, cooling operation starts.

#### 2. Checking the mal-functions of indoor / outdoor units

- 1) Any obstacles against heat release and air suction? (short circuit)  
(Forget to remove the outdoor unit cover or fallen leaves blocking the outdoor unit)
- 2) Are the indoor unit air filters clean? (obstructing heat suction)
- 3) Is the setting temperature on the remote controller correct? (is the setting temperature set at lower/higher than the room temperature?)

### 13.8.2 Understanding and verification of refrigerant cycle

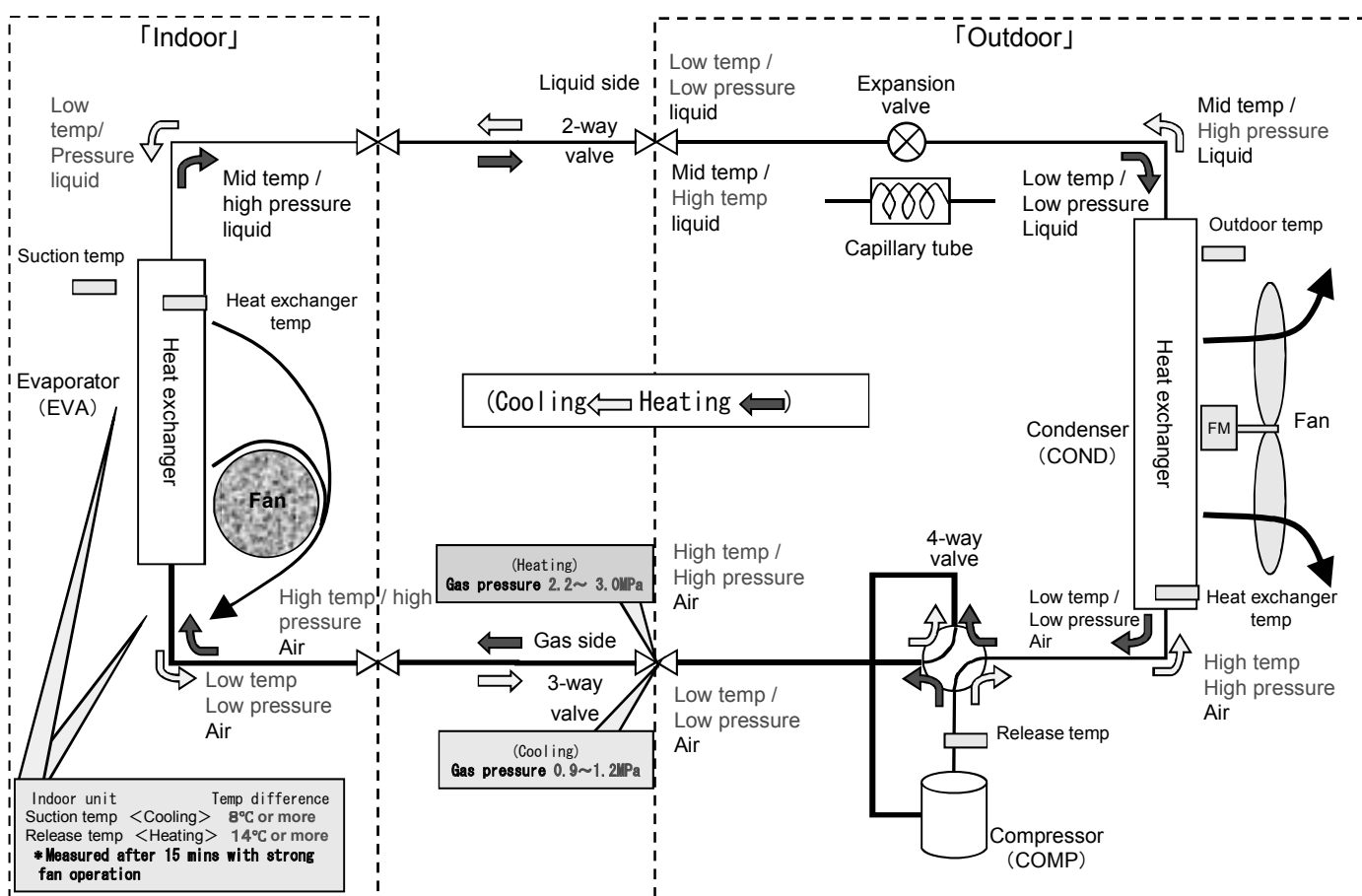

1. Measuring temperature
  - 1) Indoor unit suction temperature, release temperature, temperature difference, → Measure by thermometer
  - 2) 2-way valve pipe temperature in cooling mode is low temperature (benchmark : 5 ~ 10°C), in heating mode is medium temperature (benchmark : 25 ~ 35°C).
  - 3) 3-way valve pipe temperature in cooling mode is low temperature (benchmark : 7 ~ 15°C) in heating mode is high temperature (benchmark : 38 ~ 50°C).
2. Measuring electric current
  - Measuring electric current in operation → check by clamp meter (refer to table of technical characteristic guideline)
3. Measuring pressure
  - Measuring gas pressure → check the pressure by manifold gauge (refer to table of technical characteristic guideline)
4. Any sound from the expansion valve?  
(when starting the operation and the outdoor unit is turned on, the expansion valve is re-set, check if there is any edged sound or clack sound)

### 13.8.3 Guidance for diagnosis of refrigerant cycle

Comparison with normal operation	Cooling mode	
	High	Low
Refrigerant pressure	Excess insertion of refrigerant	Clogged capillary, expansion valve malfunction
	Heat releasing obstruction	Clog by moisture
	Dirty condenser, attachment of impurity	Lack of refrigerant gas
	Compressor malfunction	
Operation electric current	Excess insertion of refrigerant	Lack of refrigerant gas
	Heat releasing obstruction	Compressor malfunction
	Dirty condenser, impurity	Mixture of air
		(Insufficient evacuation)
2-way valve temperature	Excess insertion of refrigerant	Clogged capillary, expansion valve malfunction
	Compressor malfunction	Lack of refrigerant gas
3-way valve temperature	Lack of refrigerant gas • Compressor malfunction	Excess insertion of refrigerant
	Clogged capillary, expansion valve malfunction	

Suction temperature & Release air temperature	Temperature difference at or less than 8°C in cooling operation • • • Causes		
	• Heat releasing obstruction	• Dirty condenser	• Attachment of impurity
	• Lack of refrigerant gas	• Excess insertion of refrigerant	
	• Mixture of air	• Mixture of moisture	
	• Clogged capillary	• Expansion valve malfunction	• Compressor malfunction

◎ Above all are based on the condition that the installation work is properly performed (no issues in indoor / outdoor pipe connections, etc.)

## 14. Operation Control

### 14.1 Basic Function

Inverter control, which equipped with a microcomputer in determining the most suitable operating mode as time passes, automatically adjusts output power for maximum comfort always. In order to achieve the suitable operating mode, the microcomputer maintains the set temperature by measuring the temperature of the environment and performing temperature shifting. The compressor at outdoor unit is operating following the frequency instructed by the microcomputer at indoor unit that judging the condition according to internal setting temperature and intake air temperature.

#### 14.1.1 Internal Setting Temperature

Once the operation starts, remote control setting temperature will be taken as base value for temperature shifting processes. These shifting processes are depending on the air conditioner settings and the operation environment. The final shifted value will be used as internal setting temperature and it is updated continuously whenever the electrical power is supplied to the unit.

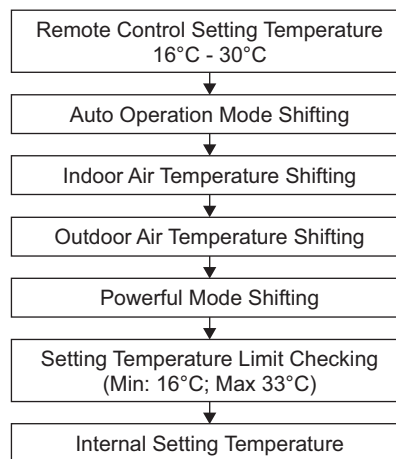

#### 14.1.2 Cooling Operation

##### 14.1.2.1 Thermostat control

- Compressor is OFF when Intake Air Temperature - Internal Setting Temperature  $< -1.5^{\circ}\text{C}$  continue for 3 minutes.
- When compressor is OFF (Thermostat OFF) and AUTO FAN is set, the fan will stop periodically.
- Compressor is ON after waiting for 3 minutes, if the Intake Air Temperature - Internal Setting Temperature  $>$  Compressor OFF point.

#### 14.1.3 Soft Dry Operation

##### 14.1.3.1 Thermostat control

- Compressor is OFF when Intake Air Temperature - Internal Setting Temperature  $< -2.0^{\circ}\text{C}$  continue for 3 minutes.
- When compressor is OFF (Thermostat OFF) and AUTO FAN is set, the fan will stop periodically.
- Compressor is ON after waiting for 3 minutes, if the Intake Air Temperature - Internal Setting Temperature  $>$  Compressor OFF point.

#### 14.1.4 Heating Operation

##### 14.1.4.1 Thermostat control

- Compressor is OFF when Intake Air Temperature - Internal Setting Temperature  $> +2.0^{\circ}\text{C}$  continue for 3 minutes.
- Compressor is ON after waiting for 3 minutes, if the Intake Air Temperature - Internal Setting Temperature  $<$  Compressor OFF point.

### 14.1.5 Automatic Operation

- This mode can be set using remote control and the operation is decided by remote control setting temperature, remote control operation mode and indoor intake air temperature.
- During operation mode judgment, indoor fan motor (with speed of Lo-) is running for 30 seconds to detect the indoor intake air temperature.
- Every 10 minutes, the indoor temperature is judged.
- For the 1st judgment
  - If indoor intake temperature - remote control setting temperature  $\geq 2^{\circ}\text{C}$ , COOL mode is decided.
  - If  $-2^{\circ}\text{C} \leq$  indoor intake temperature - remote control setting temperature  $< 2^{\circ}\text{C}$ , DRY mode is decided.
  - If indoor intake temperature - remote control setting temperature  $< -2^{\circ}\text{C}$ , HEAT mode is decided.

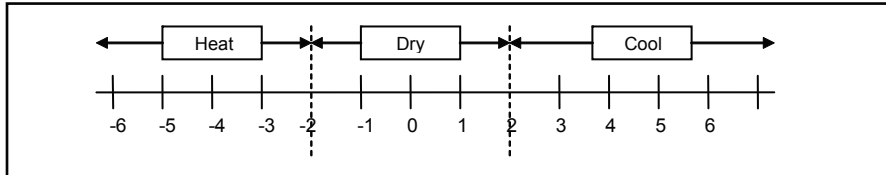

- For the 2nd judgment onwards
  - If indoor intake temperature - remote control setting temperature  $\geq 3^{\circ}\text{C}$ , if previous operate in DRY mode, then continue in DRY mode. otherwise COOL mode is decided.
  - If  $-2^{\circ}\text{C} \leq$  indoor intake temperature - remote control setting temperature  $< 3^{\circ}\text{C}$ , maintain with previous mode.
  - If indoor intake temperature - remote control setting temperature  $< -2^{\circ}\text{C}$ , HEAT mode is decided.

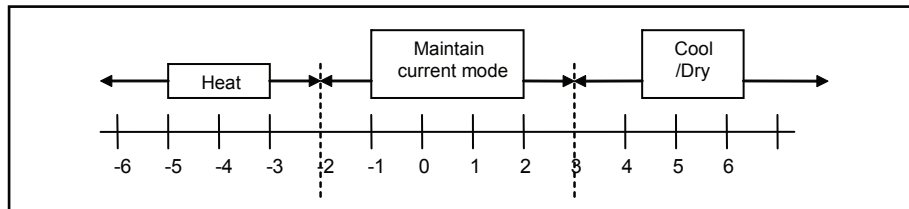

## 14.2 Indoor Fan Motor Operation

### 14.2.1 Basic Rotation Speed (rpm)

#### A. Basic Rotation Speed (rpm)

##### i. Manual Fan Speed

[Cooling, Dry]

- Fan motor's number of rotation is determined according to remote control setting.

Remote control	○	○	○	○	○
Tab	Hi	Me+	Me	Me-	Lo

[Heating]

- Fan motor's number of rotation is determined according to remote control setting.

Remote control	○	○	○	○	○
Tab	SHi	Me+	Me	Me-	Lo

##### ii Auto Fan Speed

[Cooling, Dry]

- According to room temperature and setting temperature, indoor fan speed is determined automatically.
- When set temperature is not achieved, the indoor fan will operate according to pattern below.

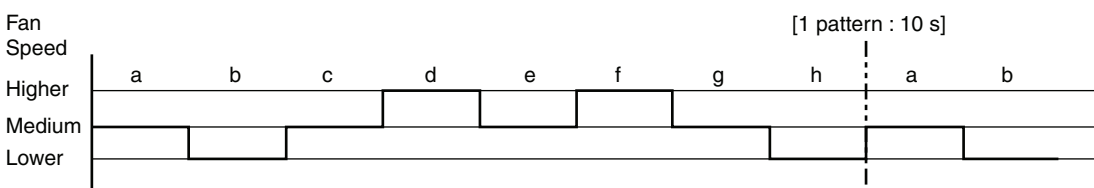

- When set temperature achieved, the indoor fan speed will be fixed. When thermostat off, the fan stop periodically.

[Heating]

- According to indoor pipe temperature, automatic heating fan speed is determined as follows.

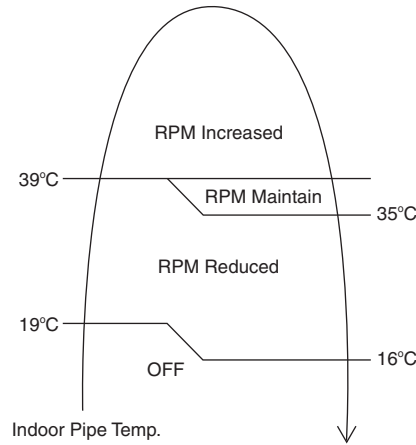

**B. Feedback control**

- Immediately after the fan motor started, feedback control is performed once every second.
- During fan motor on, if fan motor feedback  $\geq 2550$  rpm or  $< 50$  rpm continue for 10 seconds, then fan motor error counter increase, fan motor is then stop and restart. If the fan motor counter becomes 7 times, then H19 - fan motor error is detected. Operation stops and cannot on back.

**14.3 Outdoor Fan Motor Operation**

Outdoor fan motor is operated with one fan speed only. It starts when compressor starts operation and it stops 30 seconds after compressor stops operation.

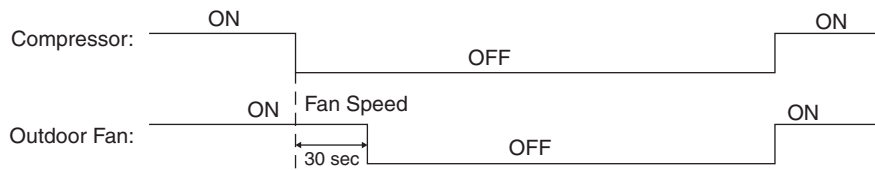

- During cooling operation, and outdoor ambient temperature is below  $8^{\circ}\text{C}$ , outdoor fan speed will be controlled according to outdoor piping temperature as following:

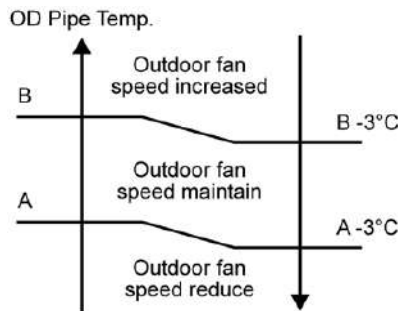

	OD Pipe Temperature
A	$26^{\circ}\text{C}$
B	$33^{\circ}\text{C}$

- During above condition, when indoor heat exchanger temperature is below  $5^{\circ}\text{C}$ , the outdoor fan will stop according to outdoor piping temperature as following:

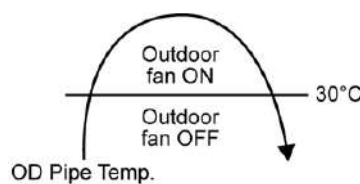

## 14.4 Airflow Direction

- There are two types of airflow, vertical airflow (directed by horizontal vane) and horizontal airflow (directed by vertical vanes).
- Control of airflow direction can be automatic (angles of direction is determined by operation mode, heat exchanger temperature and intake air temperature) and manual (angles of direction can be adjusted using remote control).

### 14.4.1 Vertical Airflow

(TZ20/25/35/42/50WK RZ20/25/35/50WK)

Operation Mode	Airflow Direction	Inner Vane Angle (°) measured from reference point					Outer Vane Angle (°) measured from reference point					
		1	2	3	4	5	1	2	3	4	5	
Cooling	Auto	5 ~ 45					0 ~ 40					
	Manual	5	21	30	38	45	0	17	25	33	40	
Soft Dry	Auto	5 ~ 45					0 ~ 40					
	Manual	5	21	30	38	45	0	17	25	33	40	
Heating	Auto	A	21					17				
		B	52					47				
		C	21					17				
	Manual	21	31	41	52	61	17	26	36	47	56	

(TZ60/71WK)

Operation Mode	Airflow Direction	Inner Vane Angle (°) measured from reference point					Outer Vane Angle (°) measured from reference point					
		1	2	3	4	5	1	2	3	4	5	
Cooling	Auto	10 ~ 60					6 ~ 34					
	Manual	10	15	30	45	60	6	17	23	28	34	
Soft Dry	Auto	10 ~ 60					6 ~ 34					
	Manual	10	15	30	45	60	6	17	23	28	34	
Heating	Auto	A	10					9				
		B	60					37				
		C	15					17				
	Manual	10	15	38	60	70	9	17	28	37	49	

- 1 Automatic vertical airflow direction can be set using remote control; the vane swings up and down within the angles as stated above. For heating mode operation, the angle of the vane depends on the indoor heat exchanger temperature as Figure 1 below. It does not swing during fan motor stop. When the air conditioner is stopped using remote control, the vane will shift to close position.
- 2 Manual vertical airflow direction can be set using remote control; the angles of the vane are as stated above and the positions of the vane are as Figure 2 below. When the air conditioner is stopped using remote control, the vane will shift to close position.

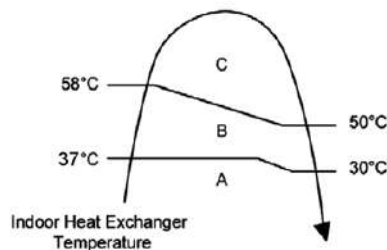

Figure 1

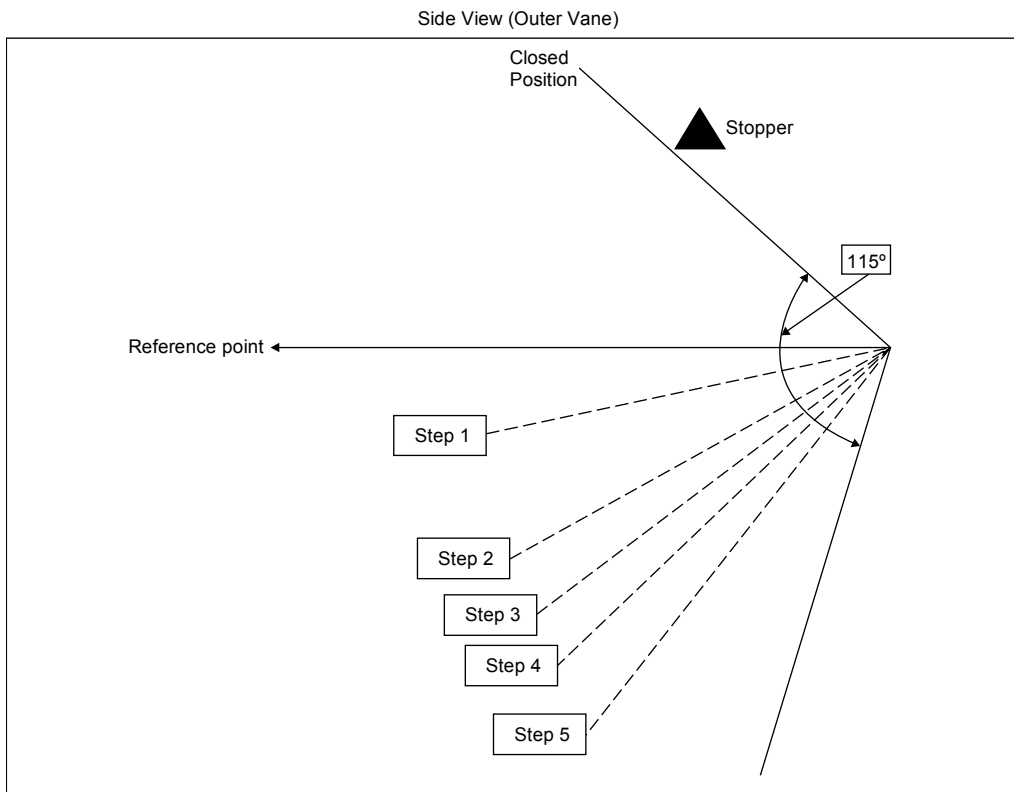
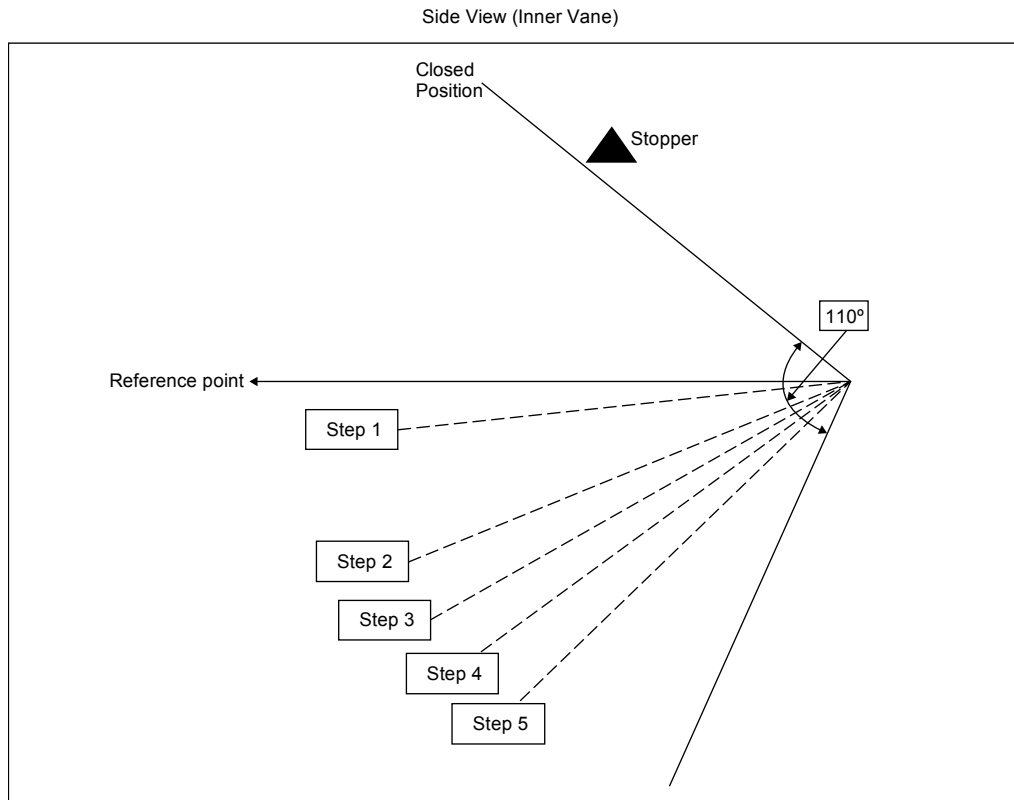

Figure 2

\* The horizontal vane angle tolerance is within +/- 5 degree.

(TZ60/71WK)

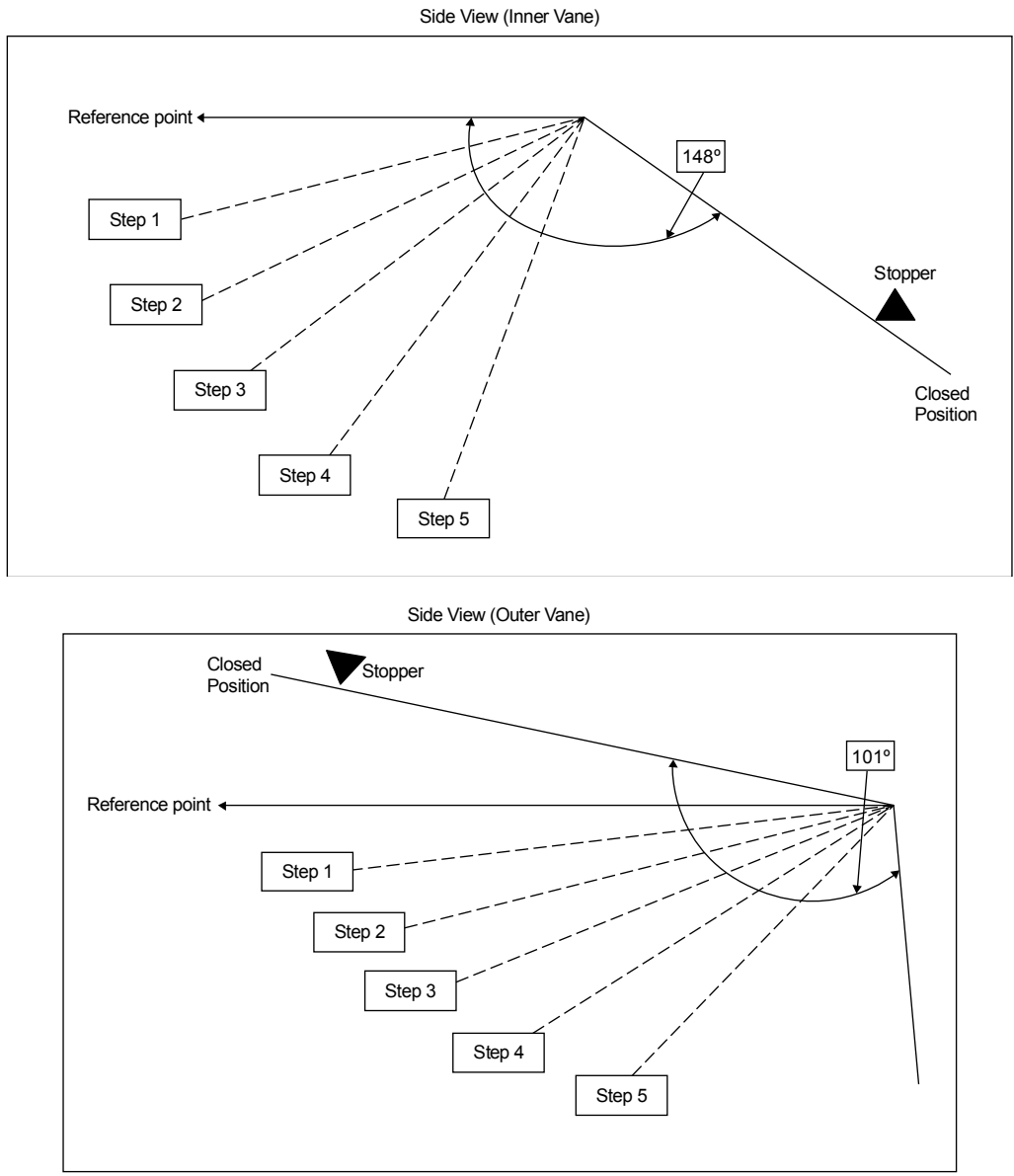

Figure 2

\* The horizontal vane angle tolerance is within +/- 5 degree.

**14.4.2 Horizontal Airflow**

(TZ20/25/35/42/50WK RZ20/25/35/50WK)

- The horizontal airflow direction louver can be adjusted manually by hand.

(TZ60/71WK)

- Automatic horizontal airflow direction can be set using remote control; the vane swings left and right within the angles as stated below. For heating mode operation, the angle of the vane depends on the indoor heat exchanger temperature as Figure 1 below. It does not swing during fan motor stop.

Operation Mode		Vane Angle (°)
Heating, with heat exchanger temperature	A	65 ~ 115
	B	90
Cooling and soft dry		65 ~ 115

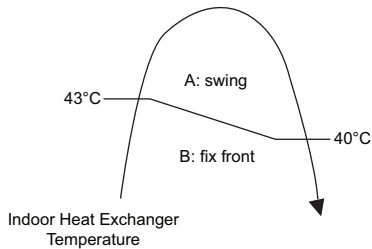

Figure 1

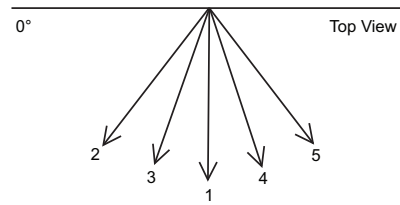

Figure 2

- Manual horizontal airflow direction can be set using remote control; the angles of the vane are as stated below and the positions of the vane are as Figure 2 above.

Pattern	1	2	3	4	5
Airflow Direction Patterns at Remote Control					
Vane Angle (°)	90	65	77.5	102.5	115

\* The vertical vane angle tolerance is within +/- 5 degree.

## 14.5 Timer Control

- There are 2 sets of ON and OFF timer available to turn the unit ON or OFF at different preset time.
- If more than one timer had been set, the upcoming timer will be displayed and will activate in sequence.

### 14.5.1 ON Timer Control

- ON timer 1 and ON timer 2 can be set using remote control, the unit with timer set will start operate earlier than the setting time.  
This is to provide a comfortable environment when reaching the set ON time.
- 60 minutes before the set time, indoor (at fan speed of Lo-) and outdoor fan motor start operate for 30 seconds to determine the indoor intake air temperature and outdoor air temperature in order to judge the operation starting time.
- From the above judgment, the decided operation will start operate earlier than the set time as shown below.

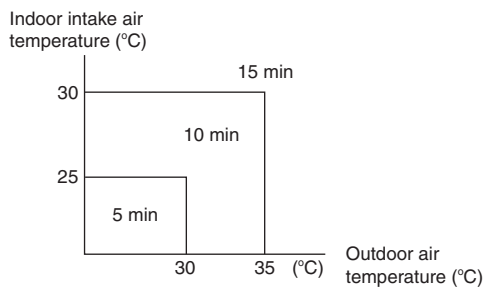

Cooling/Soft Dry

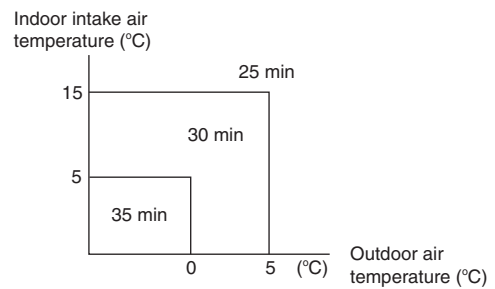

Heating

### 14.5.2 OFF Timer Control

OFF timer 1 and OFF timer 2 can be set using remote control, the unit with timer set will stop operate at set time.

## 14.6 Sleep Mode Operation

This operation provide comfortable environment while sleeping. It will automatically adjust the sleep pattern temperature during the activation period.

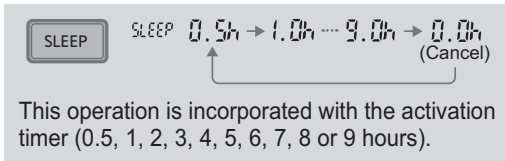

Start Condition:

- Sleep button on remote controller is pressed.
- Select OFF timer: 0.5, 1, 2, 3, 4, 5, 6, 7, 8, 9 hours.

Control content:

- Sleep function maximum running hour is 9 hours.
  - When Sleep off timer running out, unit will automatically OFF.
  - When unit resume from power failure, Sleep function will not resume.
  - Sleep operation can be set together with Timer operation. Sleep operation has priority over OFF Timer.
  - Indicator shall be dimmed when this operation is activated.
- Control pattern
- Cooling mode

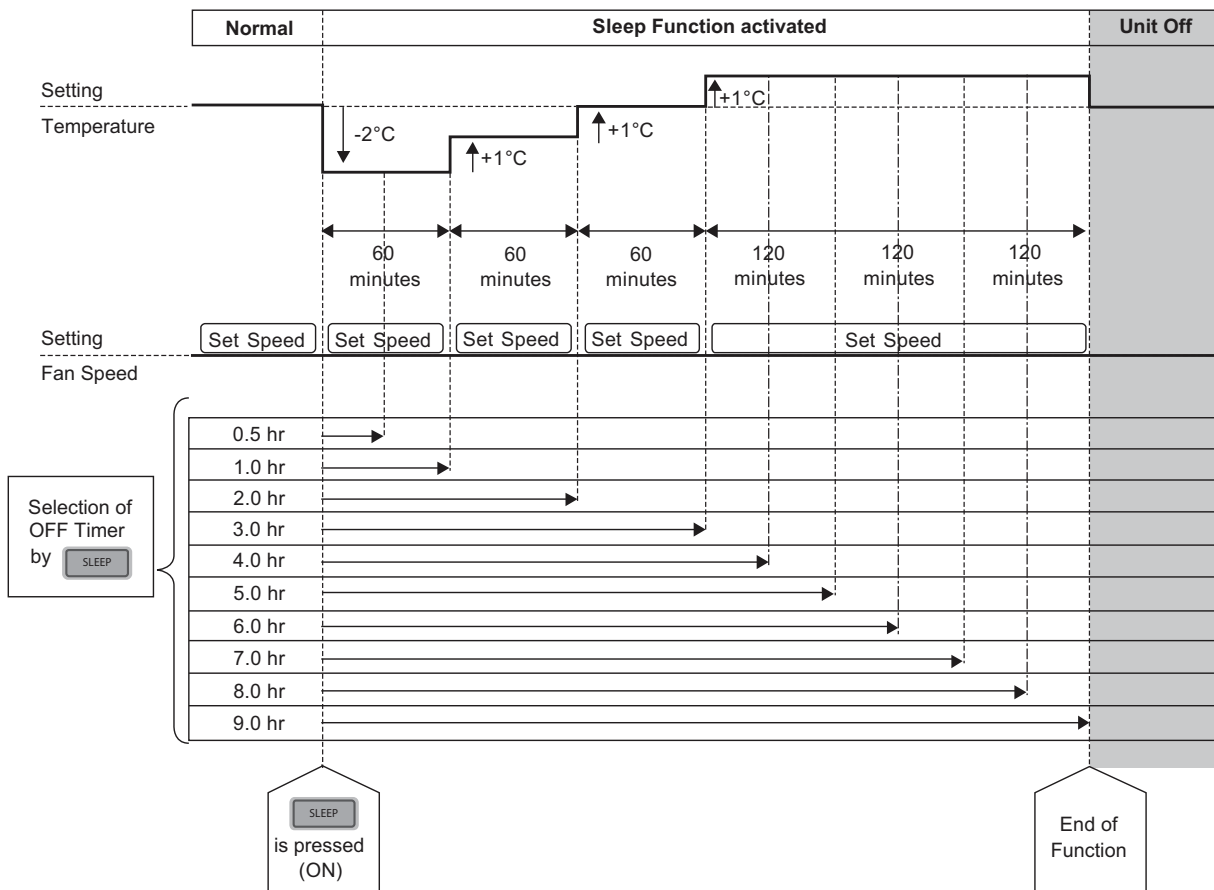

- Heating mode

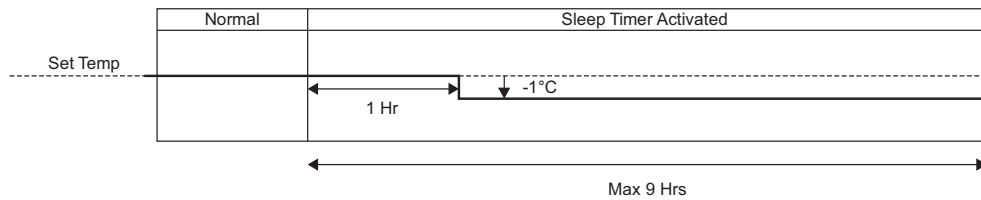

- Sleep operation will not undergo temperature shift when it collaborate with below operation. However, it will execute the delay timer.
  - Powerful mode operation
  - Auto mode operation

Stop Condition:

- When sleep operation is cancel by pressing respective button until sleep timer reaches 0.0h.
- ON/OFF button is pressed.
- When sleep operation ends.

### 14.7 Auto Restart Control

- When the power supply is cut off during the operation of air conditioner, the compressor will re-operate within three to four minutes (there are 10 patterns between 2 minutes 58 seconds and 3 minutes 52 seconds to be selected randomly) after power supply resumes.
- This type of control is not applicable during ON/OFF Timer setting.
- This control can be omitted by open the circuit of JP1 at indoor unit printed circuit board.

### 14.8 Indication Panel

LED	POWER	TIMER	
Color	White	White	White
Light ON	Operation ON	Timer Setting ON	Wireless LAN ON
Light OFF	Operation OFF	Timer Setting OFF	Wireless LAN OFF

Note:

- If POWER LED is blinking, the possible operation of the unit are Hot Start, during Deice operation, operation mode judgment, or ON timer sampling.
- If Timer LED is blinking, there is an abnormality operation occurs.

### 14.9 Quiet Operation (Cooling Mode/Cooling Area of Dry Mode)

#### A. Purpose

To provide quiet cooling operation compare to normal operation.

#### B. Control condition

- Quiet operation start condition
  - When "FAN SPEED/QUIET" button at remote control is pressed continuously until QUIET will be shown on remote control display.
- Quiet operation stop condition
  - When one of the following conditions is satisfied, quiet operation stops:
    - POWERFUL button is pressed.
    - Stop by OFF/ON switch.
    - Timer "off" activates.
    - When FAN SPEED/QUIET button is pressed again and fan speed is change to Low.
    - Sleep mode timer delay OFF.
  - When quiet operation is stopped, operation is shifted to normal operation with previous setting.
  - When operation mode is changed, quiet operation is shifted to quiet operation of the new mode.
  - During quiet operation, if timer "on" activates, quiet operation maintains.
  - After off, when on back, quiet operation is memorized.

#### C. Control contents

- Fan speed is changed to QLo.

## 14.10 Quiet Operation (Heating)

### A. Purpose

To provide quiet heating operation compare to normal operation.

### B. Control condition

- a. Quiet operation start condition
  - o When "FAN SPEED/QUIET" button at remote control is pressed continuously until QUIET will be shown on remote control display.
- b. Quiet operation stop condition
  - 1 When one of the following conditions is satisfied, quiet operation stops:
    - a. POWERFUL button is pressed.
    - b. Stop by OFF/ON switch.
    - c. Timer "off" activates.
    - d. When FAN SPEED/QUIET button is pressed again and fan speed is change to Low.
    - e. Sleep mode timer delay OFF.
  - 2 When quiet operation is stopped, operation is shifted to normal operation with previous setting.
  - 3 When operation mode is changed, quiet operation is shifted to quiet operation of the new mode.
  - 4 During quiet operation, if timer "on" activates, quiet operation maintains.
  - 5 After off, when on back, quiet operation is memorized.

### C. Control contents

- 1 Fan speed is changed to QLo.

## 14.11 Powerful Mode Operation

- When the powerful mode is selected, the internal setting temperature will shift lower up to 2°C (for Cooling/Soft Dry) or higher up to 3.5°C (for Heating) than remote control setting temperature for 20 minutes to achieve the setting temperature quickly.

## 14.12 Wireless LAN Control

### 14.12.1 System Overview

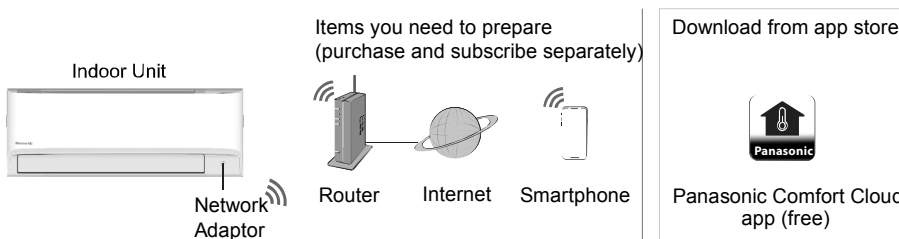

- Requires the APP to work with a smartphone with Android 4.4 and above, or iOS 9 and above. However, there is no guarantee that the APP will work well with all Android OS version.
- The Network Adaptor is designed specifically as a terminal for Panasonic Comfort Cloud app.
- The Wireless LAN network coverage must reach the air conditioner installation location.

### Specification

Network Adaptor	Wireless LAN Module (built-in)
Model	DNSK-P11
Input Voltage	DC 5V (From Air Conditioner Indoor Unit)
Current Consumption	Tx/Rx max. 290/100 mA
Wireless LAN standard	IEEE 802.11 b/g/n
Frequency range	2.4 GHz band
Encryption	WPA2-PSK (TKIP/AES)

### Precaution

- Do NOT disassemble or alter this Network Adaptor in any way.
- Do NOT remove this Network Adaptor from the appliance product's during operations.
- Data transmitted and received over radio waves may be intercepted and monitored.

### Usage precautions

- Before using this product, be sure to read all the precautions in this manual for proper use. The Company is not liable for any defects and damages, unless legal liability is recognized, in regards to failures, incurred by use of this product that occur through incorrect use or during use by yourself or a third party.

### Security Measure



- Wireless LAN uses radio waves to exchange information. Therefore, there is a risk of unauthorized access.
- Initialize the APP settings on the product prior to disposal or transferring to a third party.

### Before setting

- Confirm the wireless router is connected to the network correctly.
- Confirm the Wireless LAN of the smartphone is activated.
- Smartphone and air conditioner should be connected to the same wireless router.

## 14.12.2 Connecting Network



Before attempting to connect to the network, ensure the modem or wireless router is working and properly connected to allow internet access.

- Press  at the remote control to communicate with the home wireless LAN access point.
- Wireless LAN LED  from the indoor unit blinks to indicate the connection status to home access point.

Fast blink	The unit is establishing the connection.
Slow blink	The unit is not securing the connection.
No blink (stays on)	The unit has established the connection.

- It can establish the connection to the unit even if the unit is turned OFF.

## 14.12.3 Application Installation

For Android user (Android 4.4 and above) • Open  • Search for Panasonic Comfort Cloud app. • Download and install.	For iOS user (iOS 9 and above) • Open  • Search for Panasonic Comfort Cloud app. • Download and install.
--	--

### Note

- The app user interface image may change for version upgrade without notification.
- There is no charge for using this application. However, other charges may be incurred for connection and operation.

## 14.12.4 To Disconnect Wireless LAN (Off Wireless LAN LED)

- Press and release one time at the Remote Control Wireless LAN button and the LED will turn off. (LED ON -> LED OFF).

## 14.12.5 To Delete Wireless LAN Information

- If Wireless LAN is off (LED is Off), turn on Wireless LAN first by press and release one time the Wireless LAN button. (LED OFF -> LED ON).
- Push Wireless LAN button for 5 seconds.
- In the Remote Control Operation select “5” and push for 3 seconds.
- Initialization is finish and Wireless LAN LED will off automatically.

## 14.12.6 To Check Wireless Lan Signal Strength

- Confirm the air conditioner operation is stopped and press the Wireless LAN button for 5 seconds.
- Select “4” in the remoco then press set button and operation stops.
- After 5 seconds, the signal strength is shown on the indoor unit Wireless LAN LED.  
Strong Signal: Blink 3 times with an interval.  
Moderate Signal: Blink 2 times with an interval.  
Weak Signal: Blink once with an interval.  
No Signal: OFF.
- It will stop automatically after 10 minutes. To stop immediately, press Wireless LAN button.

## 14.12.7 Wireless LAN Failure Diagnosis

### 14.12.7.1 Between ID Micon and Wireless LAN Module Failure Detect Condition

- When module and ID micon (CN-LAN) communication is following below condition.
  - No response against sending data.
  - Reply error against sending data.
  - Regularly sending from AC unit (Every 1 minutes).
- Either one from above condition occur, detection will start.
- If for certain time there is no communication and retry is implemented 3 times continuously confirm the error by following below table.
- When failure diagnosis H85 occur.

	Wireless LAN LED	Timer LED
When error condition check	Light up	No light
When retry	Light up	No light
After confirm failure	No light	Blinking

- Cancel Condition: From the module the reply data or the regularly sending data (normal data) is recognized by ID micon.

	Wireless LAN LED	Timer LED
When failure canceled	Light up	No light

- Failure communication parameter setting.

H85 communication error: time/retry counter	10 min/3 count
Wireless LAN disconnection judgment time	300 sec

### 14.12.8 Between ID AC and Broadband Router Failure Detect Condition

- Detect condition: Communication with router is interrupted.
- Confirm condition: The interrupted condition continue more than 5 minutes and retry is implemented.
- After confirm the failure operation: Not H85 error display and Wireless LAN LED is blinking.
- Cancel condition: Communication is return between Wireless LAN router.
- After cancel, return to normal operation and Wireless LAN LED is light up.

## **15. Operation Control (For Multi Split Connection)**

During multi split connection, indoor unit's operation controls are same with single split connection unless specified in this chapter.

### **15.1 Cooling operation**

#### **15.1.1 Thermostat control**

- Capability supply to indoor unit is OFF (Expansion valve closed) when Intake Air Temperature — Internal setting temperature  $< -2.0^{\circ}\text{C}$ .
- Capability resume supply to indoor unit after waiting for 3 minutes, if the Intake Air temperature — Internal setting temperature  $>$  Capability supply OFF point.

### **15.2 Soft Dry Operation**

#### **15.2.1 Thermostat control**

- Capability supply to indoor unit is OFF (Expansion valve closed) when Intake Air Temperature — Internal setting temperature  $< -3.0^{\circ}\text{C}$ .
- Capability resume to indoor unit after waiting for 3 minutes, if the Intake Air temperature — Internal setting temperature  $>$  Capability supply OFF point.

### **15.3 Heating Operation**

#### **15.3.1 Thermostat control**

- Capability supply to indoor unit is OFF (Expansion valve closed) when Intake Air Temperature — Internal setting temperature  $> +1.0^{\circ}\text{C}$ .
- During this condition, the indoor fan is stopped if compressor is ON.
- Capability resume supply to indoor unit after waiting for 3 minutes, if the Intake Air Temperature — Internal setting temperature  $<$  Capability supply OFF point.

#### **15.3.2 Temperature Sampling Control**

- Temperature sampling is controlled by outdoor unit where room temperature for all power supply ON indoor unit could be obtained.
- When capability supply to the indoor unit is OFF and the compressor is ON, the indoor fan motor is stopped. During this condition, 15 seconds after sampling signal from outdoor unit is received, the indoor fan start operation at low fan speed.
- However, within first 4 minutes of capability stopped supply to the indoor unit, even sampling signal is received, the sampling control is cancelled.

## 15.4 Automatic Operation

- This mode can be set using remote control and the operation is decided by remote control setting temperature, remote control operation mode, indoor intake and outdoor air temperature.
- During operation mode judgment, indoor fan motor (with speed of -Lo) and outdoor fan motor are running for 30 seconds to detect the indoor intake and outdoor air temperature. The operation mode is decided based on below chart.

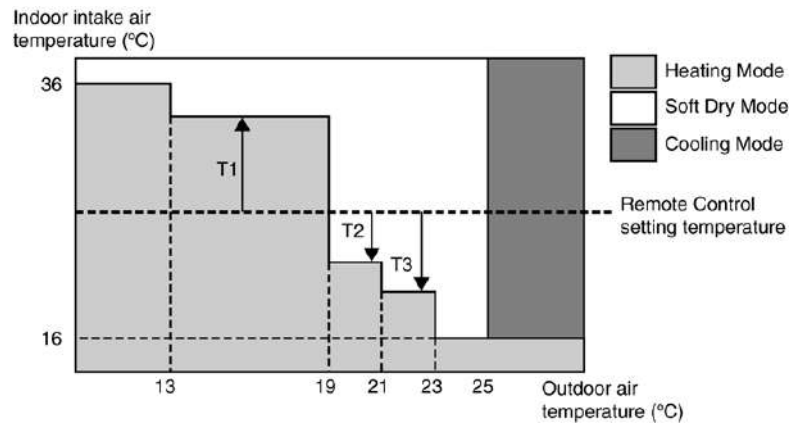

- Every 180 minutes, the indoor and outdoor temperature is judge. Based on remote control setting temperature, the value of T1 will increase up to 10°C, T2 will decrease by 3°C and T3 will decrease up to 8°C.

## 15.5 Indoor Fan Motor Operation

### 15.5.1 Residual Heat Removal Control

- To prevent high pressure at indoor unit, when heating mode thermostat-off condition or power supply OFF, indoor fan continue to operate at controlled fan speed for maximum 30 seconds then stop.

## 15.6 Powerful Mode Operation

- When the power mode is selected, the internal setting temperature will shift lower up to 4°C for Cooling/Soft Dry or higher up to 6°C for heating than remote control setting temperature, the powerful operation stop after 20 minutes or user cancel the Powerful operation by pressing powerful button again.

## 15.7 Auto Restart Control

- When the power supply is cut off during the operation of air conditioner, the compressor will re-operate between three to four minutes (10 patterns to be selected randomly) after power resume.
- During multi split connection, Indoor unit will resume previous mode, include unit standby mode.

## 15.8 Indication Panel

LED	POWER	TIMER	📶
Color	White	White	White
Light ON	Operation ON	Timer Setting ON	Wireless LAN ON
Light OFF	Operation OFF	Timer Setting OFF	Wireless LAN OFF

Note:

- If POWER LED is blinking (0.5 seconds ON, 0.5 second OFF), the possible operation of the unit are during Indoor Residual Heat Removal, Hot Start, during Deice operation, operation mode judgment, or ON timer sampling.
- If POWER LED is blinking (2.5 seconds ON, 0.5 second OFF), the unit is in standby mode.
- If TIMER LED is blinking, there is an abnormality operation occurs.

## 16. Protection Control

### 16.1 Protection Control for All Operations

#### 16.1.1 Restart Control (Time Delay Safety Control)

- The Compressor will not turn on within 3 minutes from the moment operation stops, although the unit is turned on again by pressing OFF/ON button at remote control within this period.
- This control is not applicable if the power supply is cut off and on again.
- This phenomenon is to balance the pressure inside the refrigerant cycle.

#### 16.1.2 Total Running Current

- 1 When the outdoor unit total running current (AC) exceeds X value, the frequency instructed for compressor operation will be decreased.
- 2 If the running current does not exceed X value for 5 seconds, the frequency instructed will be increased.
- 3 However, if total outdoor unit running current exceeds Y value, compressor will be stopped immediately for 3 minutes.

Model	TZ20WKE/ RZ20WKE		TZ25WKE/ RZ25WKE		TZ35WKE/ RZ35WKE		TZ42WKE		TZ50WKE/ RZ50WKE		TZ60WKE		TZ71WKE	
	X (A)	Y (A)	X (A)	Y (A)	X (A)	Y (A)	X (A)	Y (A)	X (A)	Y (A)	X (A)	Y (A)	X (A)	Y (A)
Operation Mode	4.18	15.03	5.13	15.03	6.45	15.03	7.11	15.03	10.23	14.66	10.95	14.66	14.57	19.01
Cooling / Soft Dry (A)	3.81		4.69		5.94		6.60		9.69		10.50		14.03	
Cooling / Soft Dry (B)	3.81		4.69		5.94		6.60		9.69		10.50		14.03	
Cooling / Soft Dry (C)	4.40		4.91		6.09		9.31		9.41		9.96		11.22	
Heating	4.40		4.91		6.09		9.31		9.41		9.96		11.22	

- 4 The first 30 minutes of cooling operation, (A) will be applied.

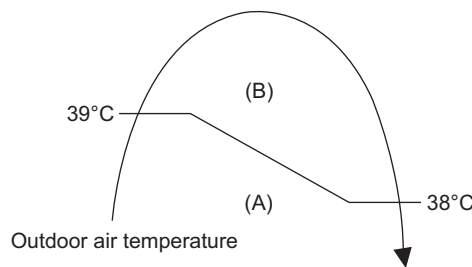

#### 16.1.3 IPM (Power transistor) Prevention Control

- Overheating Prevention Control
  - 1 When the IPM temperature rises to 120°C, compressor operation will stop immediately.
  - 2 Compressor operation restarts after 3 minutes the temperature decreases to 110°C.
  - 3 If this condition repeats continuously 4 times within 20 minutes, timer LED will be blinking ("F96" is indicated).
- DC Peak Current Control
  - 1 When electric current to IPM exceeds set value, the compressor will stop operate.
  - 2 If the set value is exceeded again more than 30 seconds after the compressor starts, the operation will restart after 3 minutes.
  - 3 If the set value exceeded again within 30 seconds after the compressor starts, the operation will restart after 1 minute. If this condition repeats continuously for 7 times, all indoor and outdoor relays will be cut off, timer LED will be blinking ("F99" is indicated).

#### 16.1.4 Compressor Overheating Prevention Control

- Instructed frequency for compressor operation will be regulated by compressor temperature. The changes of frequency are as below.
- If compressor temperature exceeds 103°C, compressor will be stopped, occurs 4 times per 20 minutes, timer LED will be blinking. ("F97" is indicated.)

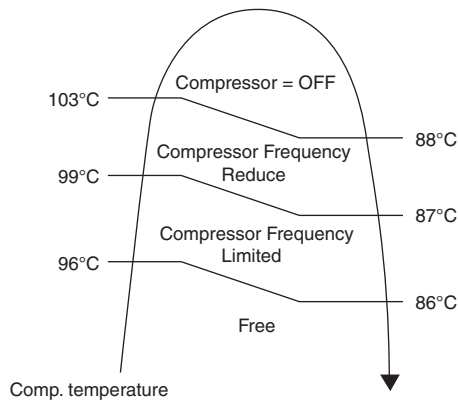

### 16.1.5 Low Pressure Prevention Control (Gas Leakage Detection)

- Control start conditions
  - For 5 minutes, the compressor continuously operates and outdoor total current is between 0.29A and 0.44A (TZ20/25/35/42WK, RZ20/25/35WK) 0.36A and 0.54A (TZ50/60/71WK, RZ50WK).
  - During Cooling and Soft Dry operations:  
Indoor suction temperature - indoor piping temperature is below 4°C.
  - During Heating operations :  
Indoor piping temperature - indoor suction is under 5°C.
- Control contents
  - Compressor stops (and restart after 3 minutes).
  - If the conditions above happen 2 times within 20 minutes, the unit will:
    - Stop operation
    - Timer LED blinks and “F91” indicated.

### 16.1.6 Low Frequency Protection Control 1

- When the compressor operate at frequency lower than 24 Hz continued for 20 minutes, the operation frequency will be changed to 23 Hz for 2 minutes.

### 16.1.7 Low Frequency Protection Control 2

- When all the below conditions comply, the compressor frequency will change to lower frequency.

Temperature, T, for:	Cooling/Soft Dry	Heating
Indoor intake air (°C)	$T < 14$ or $T \geq 30$	$T < 14$ or $T \geq 28$
Outdoor air (°C)	$T < 13$ or $T \geq 38$	$T < 4$ or $T \geq 24$
Indoor heat exchanger (°C)	$T < 30$	$T \geq 0$

## 16.2 Protection Control for Cooling & Soft Dry Operation

### 16.2.1 Outdoor Air Temperature Control

- The compressor operating frequency is regulated in accordance to the outdoor air temperature as shown in the diagram below.
- This control will begin 1 minute after the compressor starts.
- Compressor frequency will adjust base on outdoor air temperature.

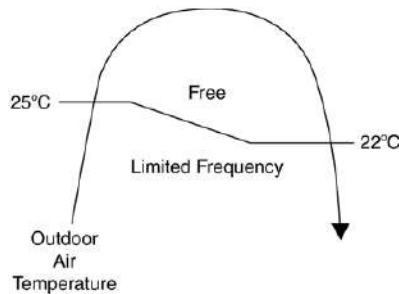

- The compressor will be stopped to avoid compressor overloading.

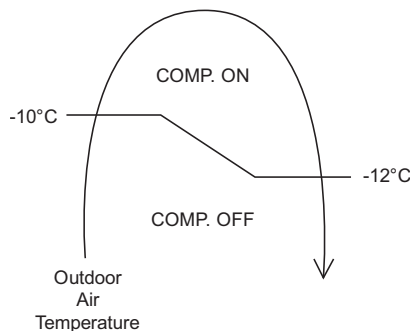

### 16.2.2 Cooling Overload Control

- Detects the Outdoor pipe temperature and carry out below restriction/limitation (Limit the compressor Operation frequency).
- The compressor stop if outdoor pipe temperature exceeds 60°C.
- If the compressor stops 4 times in 20 minutes, Timer LED blinking (F95 indicated: outdoor high pressure rise protection).

### 16.2.3 Freeze Prevention Control 1

- When indoor heat exchanger temperature is lower than 0°C continuously for 6 minutes, compressor will stop operating.
- Compressor will resume its operation 3 minutes after the indoor heat exchanger is higher than 5°C.
- At the same time, indoor fan speed will be higher than during its normal operation.
- If indoor heat exchanger temperature is higher than 13°C, the fan speed will return to its normal operation.

### 16.2.4 Freeze Prevention Control 2

- Control start conditions
  - During Cooling operation and soft dry operation
    - During thermo OFF condition, indoor intake temperature is less than 10°C or
    - Compressor stops for freeze prevention control
  - Either one of the conditions above occurs 5 times in 60 minutes.
- Control contents
  - Operation stops
  - Timer LED blinks and "H99" indicated

### 16.2.5 Dew Prevention Control 1

- To prevent dew formation at indoor unit discharge area.
- This control will be activated if:
  - Outdoor air temperature and Indoor pipe temperature judgment by microcontroller is fulfilled.
  - When Cooling or Dry mode is operated more than 20 minutes or more.
- This control stopped if:
  - Compressor stopped.
  - Remote control setting changed (fan speed / temperature).
  - Outdoor air temperature and indoor intake temperature changed.
- Fan speed will be adjusted accordingly in this control.

### 16.2.6 Odor Cut Control

- To reduce the odor released from the unit.
  - Start Condition
    - AUTO FAN Speed is selected during COOL or DRY operation.
    - During freeze prevention control and timer preliminary operation, this control is not applicable.
  - Control content
    - Depends on compressor conditions:
      1. Compressor OFF → Compressor ON.  
The indoor unit fan stops temporarily and then starts to blow at minimum airflow for 30 seconds.
      2. Compressor ON → Compressor OFF.  
The indoor unit fan stops for 90 seconds and then blows at minimum airflow for 20 seconds.

## 16.3 Protection Control for Heating Operation

### 16.3.1 Intake Air Temperature Control

Compressor will operate at limited freq., if indoor intake air temperature is 30°C or above.

### 16.3.2 Outdoor Air Temperature Control

- The Max current value is regulated when the outdoor air temperature rise above 14°C in order to avoid compressor overloading.

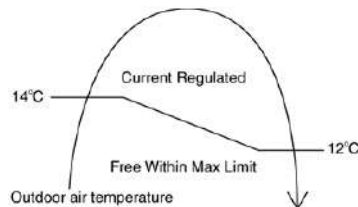

### 16.3.3 Overload Protection Control

- The compressor operating frequency is regulated in accordance to indoor heat exchanger temperature as shown below.
- If the heat exchanger temperature exceeds 60°C, compressor will stop.

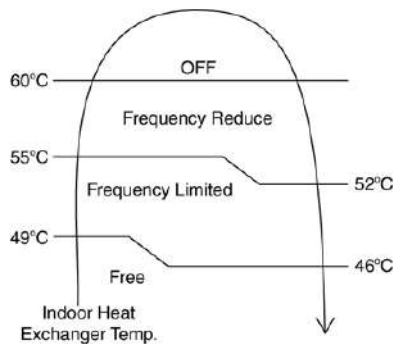

### 16.3.4 Low Temperature Compressor Oil Return Control

- In heating operation, if the outdoor temperature falls below -10°C when compressor starts, the compressor frequency will be regulated up to 600 seconds.

### **16.3.5 Cold Draught Prevention Control**

- When indoor pipe temperature is low, cold draught operation starts where indoor fan speed will be reduced.

### **16.3.6 Deice Operation**

- When outdoor pipe temperature and outdoor air temperature is low, deice operation start where indoor fan motor and outdoor fan motor stop and operation LED blinks.

### **16.3.7 Low Pressure Protection Control**

- During low ambient heating operation, if the pipe temperature drops below  $-22^{\circ}\text{C}$ , the max frequency will be reduced and limited.
- If it does not rises after 3 minutes, the compressor will stop.
- The compressor will start again if the pipe temperature rises above  $-18^{\circ}\text{C}$ .

# 17. Servicing Mode

## 17.1 Auto OFF/ON Button

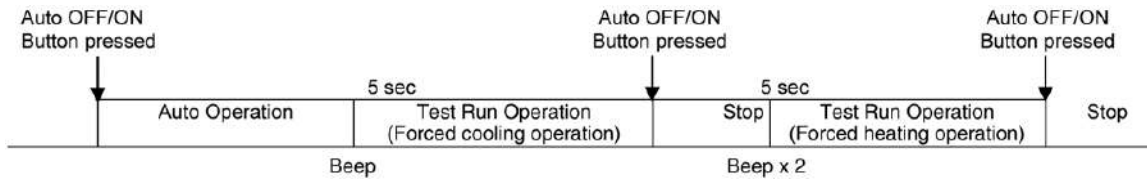

### 1 AUTO OPERATION MODE

The Auto operation will be activated immediately once the Auto OFF/ON button is pressed. This operation can be used to operate air conditioner with limited function if remote control is misplaced or malfunction.

### 2 TEST RUN OPERATION (FOR PUMP DOWN/SERVICING PURPOSE)

The Test Run operation will be activated if the Auto OFF/ON button is pressed continuously for more than 5 seconds. A “beep” sound will heard at the fifth seconds, in order to identify the starting of Test Run operation (Forced cooling operation). Within 5 minutes after Forced cooling operation start, the Auto OFF/ON button is pressed for more than 5 seconds. A 2 “beep” sounds will heard at the fifth seconds, in order to identify the starting of Forced heating operation.

The Auto OFF/ON button may be used together with remote control to set / change the advance setting of air conditioner operation.

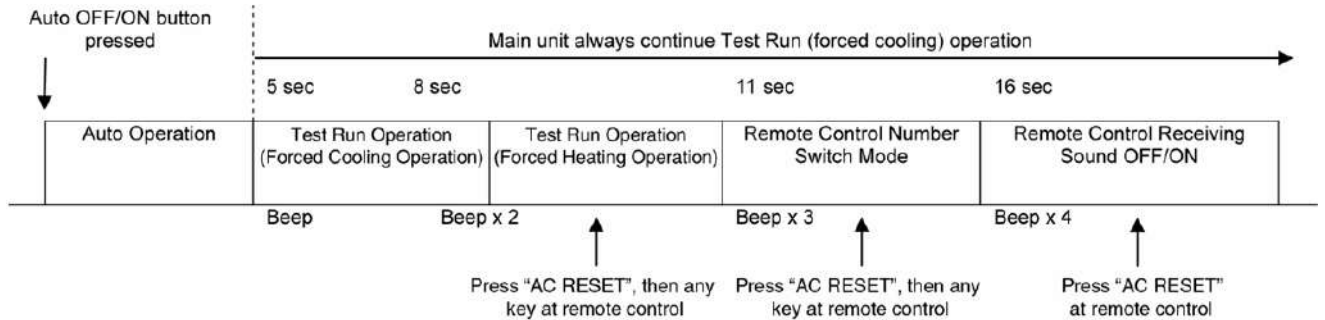

### 3 REMOTE CONTROL NUMBER SWITCH MODE

The Remote Control Number Switch Mode will be activated if the Auto OFF/ON button is pressed continuously for more than 11 seconds (3 “beep” sounds will occur at 11th seconds to identify the Remote Control Number Switch Mode is in standby condition) and press “AC RESET” button and then press any button at remote control to transmit and store the desired transmission code to the EEPROM.

There are 4 types of remote control transmission code could be selected and stored in EEPROM of indoor unit. The indoor unit will only operate when received signal with same transmission code from remote control. This could prevent signal interference when there are 2 or more indoor units installed nearby together. To change remote control transmission code, short or open jumpers at the remote control printed circuit board.

Remote Control Printed Circuit Board		
Jumper A (J-A)	Jumper B (J-B)	Remote Control No.
Short	Open	A (Default)
Open	Open	B
Short	Short	C
Open	Short	D

- During Remote Control Number Switch Mode, press any button at remote control to transmit and store the transmission code to the EEPROM.

#### 4 REMOTE CONTROL RECEIVING SOUND OFF/ON MODE

The Remote Control Receiving Sound OFF/ON Mode will be activated if the Auto OFF/ON button is pressed continuously for more than 16 seconds (4 “beep” sounds will occur at 16th seconds to identify the Remote Control Receiving Sound Off/On Mode is in standby condition) and press “AC Reset” button at remote control.





Press “Auto OFF/ON button” to toggle remote control receiving sound.

- Short “beep”: Turn OFF remote control receiving sound.
- Long “beep”: Turn ON remote control receiving sound.

After Auto OFF/ON Button is pressed, the 20 seconds counter for Remote Control Receiving Sound OFF/ON Mode is restarted.

## 17.2 Heat Only Operation

### 17.2.1 How to Activate/Deactivate Heat only Operation

- Use remote controller to set heating only operation. When the unit in standby mode, follow the steps below:
  - a) Press  continuously for more than 5 seconds to enter special setting mode.
  - b) Press  to choose function 61, and then press  or  to set “01”. (To enable the “Heat Only” mode) or “00” (To disable the “Heat Only” mode).
  - c) Press  to activate “Heating only operation” or deactivate “Heating only operation”.

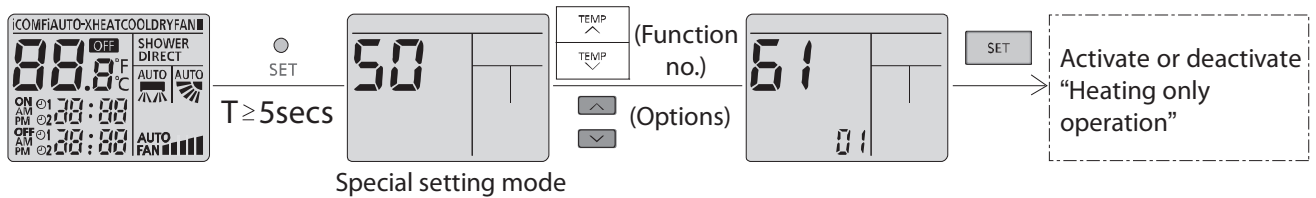

## 17.2.2 Operation mode during Heating Only Operation

- The table below shows the operation mode comparison when Heating Only Operation Mode Activated and Deactivated.

Operation Mode	Heating Only Operation Mode Activated	Heating Only Operation Mode Deactivated
AUTO	After 30s sampling, regardless of the indoor intake or outdoor intake temperature judgment, the unit will run Heating operation.	After 30s sampling, the unit will judge the operation mode base on remote controller temperature setting and Indoor Intake Sensor (New Auto Mode) or Outdoor Intake Sensor (Old Auto Mode).
HEAT	The unit will run Heating operation.	The unit will run Heating operation.
COOL	The unit will stop and Power LED blinking.	The unit will run Cooling operation.
DRY	The unit will stop and Power LED blinking.	The unit will run Cooling Dry operation.
NANOE-G Stand-alone	The unit will stop and Power LED blinking.	The unit will run Nanoe-G Stand-alone operation.
Force Cooling	The unit will run Force Cooling Operation for X_CTRYTM [15] minutes	The unit will run Force Cooling operation.
Force Heating	The unit will run Force Heating operation.	The unit will run Force Heating operation.
AUTO (with Timer)	The unit will turn ON by the timer and run Auto Operation. After 30s sampling, regardless of the indoor intake or outdoor intake temperature judgment, the unit will run Heating operation.	The unit will turn ON by the timer and run Auto Operation. After 30s sampling, the unit will judge the operation mode base on remote controller temperature setting and Indoor Intake Sensor (New Auto Mode) or Outdoor Intake Sensor (Old Auto Mode).
HEAT (with Timer)	The unit will turn ON by the timer and run Heating Operation.	The unit will turn ON by the timer and run Heating Operation.
COOL (with Timer)	The unit will not turn ON by the timer. Power LED blinking.	The unit will turn ON by the timer and run Cooling Operation.
DRY (with Timer)	The unit will not turn ON by the timer. Power LED blinking.	The unit will turn ON by the timer and run Cooling Dry Operation.
Cooling Test Mode	The unit will stop and Power LED blinking.	The unit will operate according to specify Cooling test mode operation parameter.
Heating Test Mode	The unit will operate according to specify Heating test mode operation parameter.	The unit will operate according to specify Heating test mode operation parameter.



## 17.3 Remote Control Button

### 17.3.1 SET Button

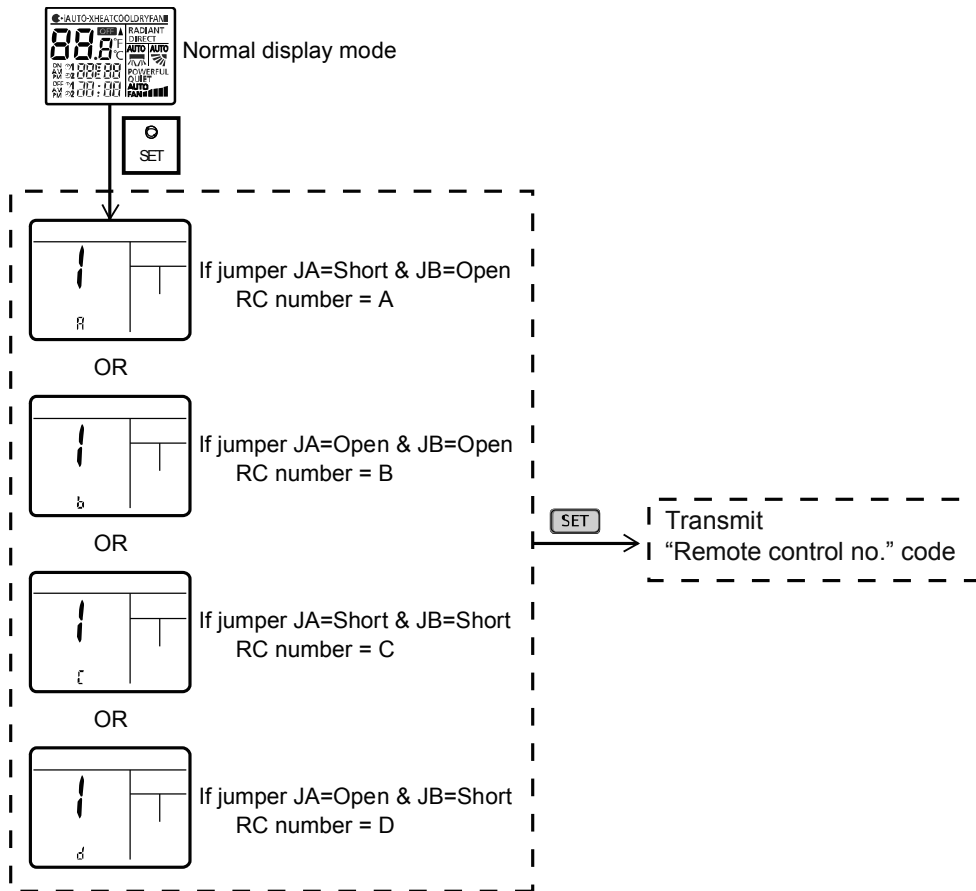
- To check remote control transmission code and store the transmission code to EEPROM.
  - Press “Set” button by using pointer.
  - Press “Timer Set” button until a “beep” sound is heard as confirmation of transmission code change.
  - LCD returns to original display if remote control does not operate for 30 seconds.



- Press **CANCEL** SW, special setting is immediately cancelled and normal mode starts.
- If no SW is pressed for 30 secs, then special setting mode is cancelled and normal mode starts.

- Under this function, only , , **SET**, **CANCEL** and  SW's are effective.

- To limit set temperature range for COOL & DRY, HEAT, AUTO mode.
  - Press “Set” button by using pointer.
  - Press TEMP increment or decrement button to choose No. 3.
  - Press Timer increment or decrement button to select desired temperature low limit of set temperature for COOL & DRY mode.

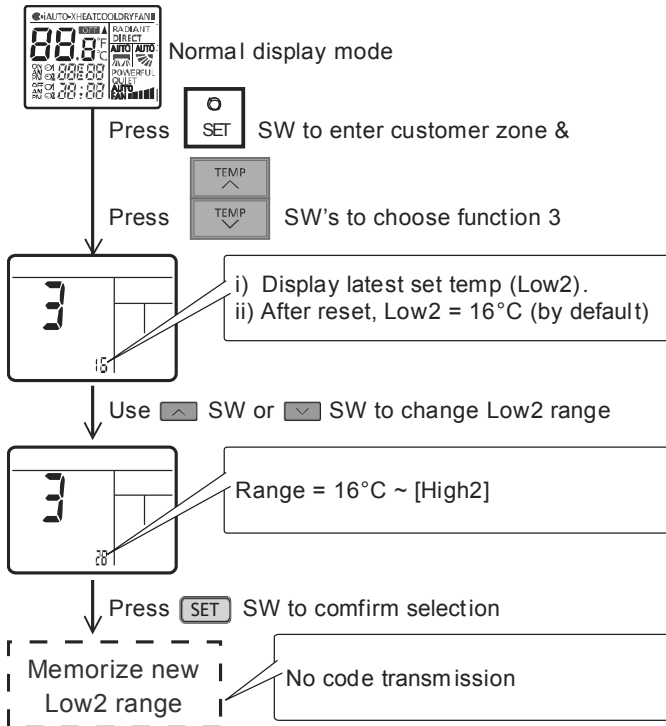

- Press Timer Set button to confirm low limit selection.
- Press TEMP increment or decrement button to choose No. 4.
- Press Timer decrement or increment button to select desired temperature high limit of set temperature for COOL & DRY mode.

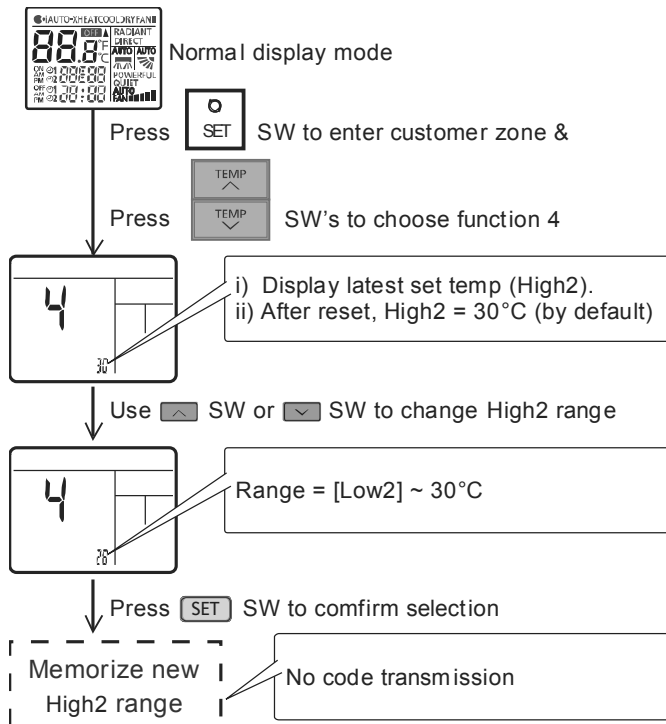

- Press Timer Set button to confirm high limit selection.

- Press TEMP increment or decrement button to choose No. 5.
- Press Timer increment or decrement button to select desired temperature low limit of set temperature for HEAT mode.

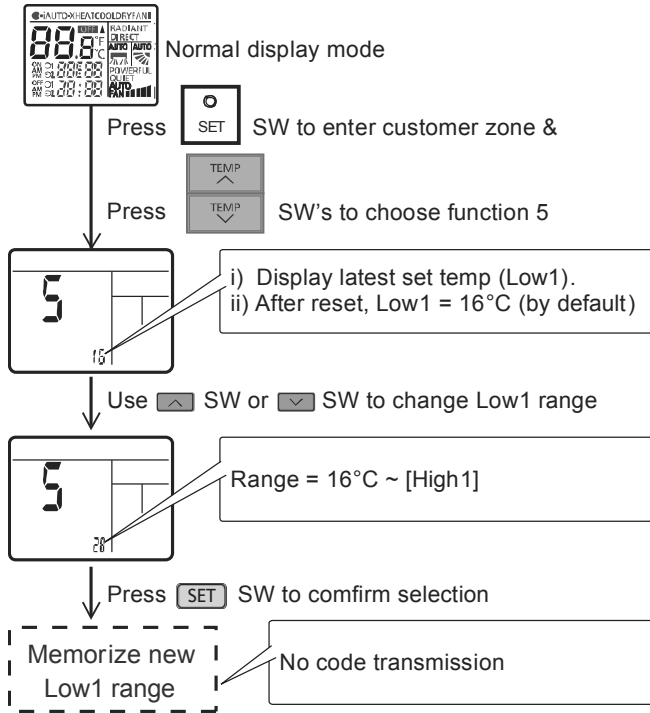

- Press Timer Set button to confirm low limit selection.
- Press TEMP increment or decrement button to choose No. 6.
- Press Timer decrement or increment button to select desired temperature high limit of set temperature for HEAT mode.

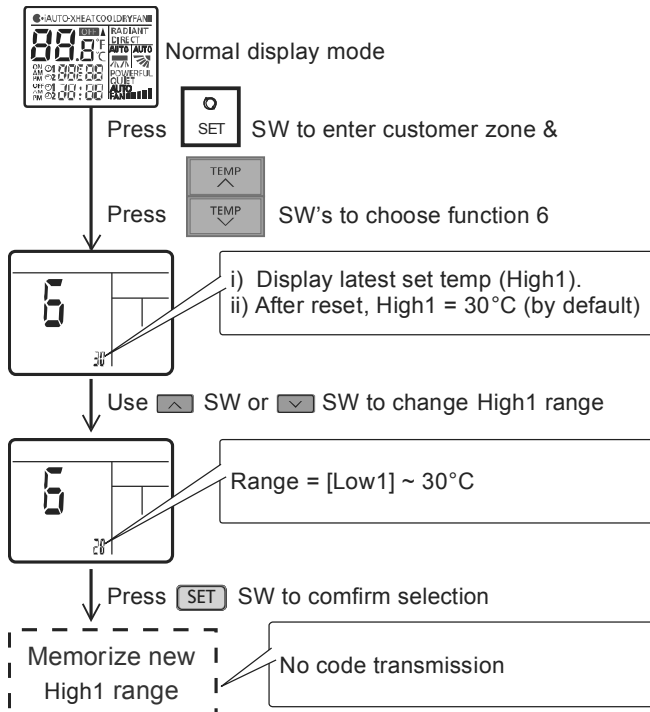

- Press Timer Set button to confirm low limit selection.

- Press TEMP increment or decrement button to choose No. 12.
- Press Timer increment or decrement button to select desired temperature low limit of set temperature for AUTO mode.

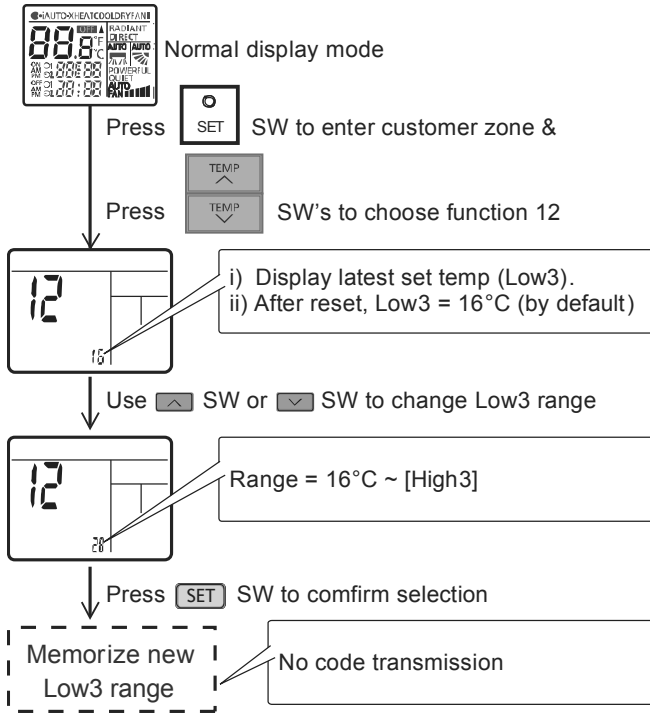

- Press Timer Set button to confirm low limit selection.
- Press TEMP increment or decrement button to choose No. 13.
- Press Timer decrement or increment button to select desired temperature high limit of set temperature for AUTO mode.

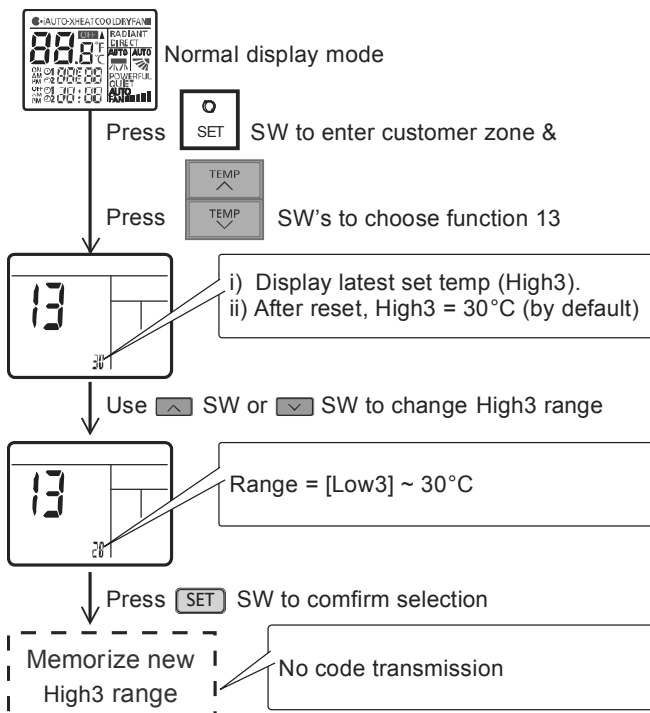

- Press Timer Set button to confirm high limit selection.
- LCD returns to original display if remote control does not operate for 30 seconds or press Timer Cancel button.

### **17.3.2 RESET (RC)**

- To clear and restore the remote control setting to factory default.
  - Press once to clear the memory.

### **17.3.3 RESET (AC)**

- To restore the unit's setting to factory default.
  - Press once to restore the unit's setting.

### **17.3.4 TIMER ▲**

- To change indoor unit indicator's LED intensity.
  - Press continuously for 5 seconds.

### **17.3.5 TIMER ▼**

- To change remote control display from Degree Celsius (°C) to Degree Fahrenheit (°F).
  - Press continuously for 10 seconds.

### 17.3.6 Customization mode

1 LCD display area:

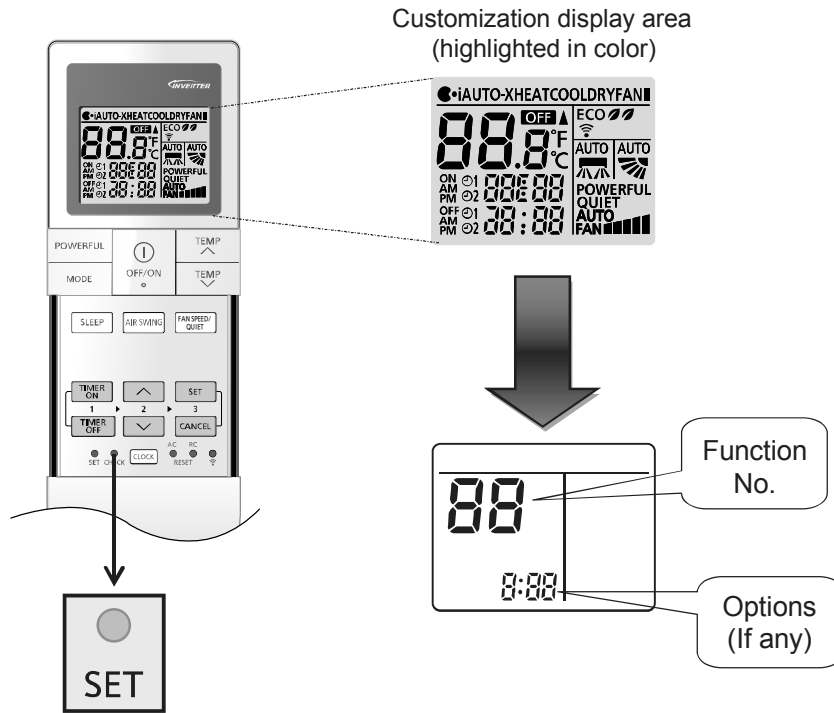

2 Cannot enter this customization mode under the following conditions:

- ① Operation ON.
- ② Under [Real/ON/OFF] time setting mode.

3 To enter Customer zone:

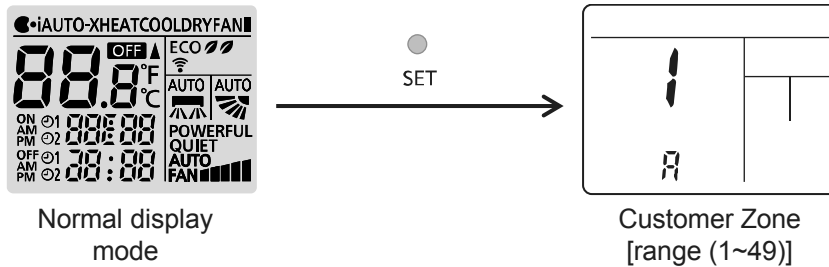

4 To enter Service zone: (Press SET continuously for T ≥ 5 secs)

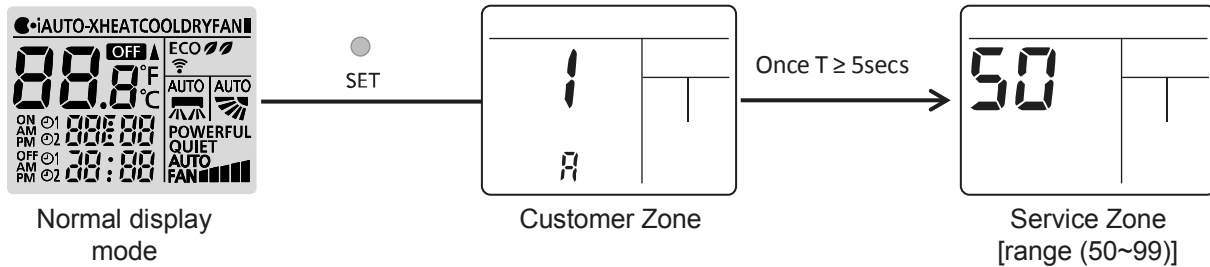

5 Customization list table:

Note: The functions described in the table may not be applicable to the model and may subject to change without further notice.

		Customization		Options	Remark
No	Name				
Customer Zone	1	Remote control number selection		A, B, C, D	
	2	Solar radiation sensitivity level adjustment		1, 2, 3, 4, 5	
	3	[iAUTO-X/iAUTO/iCOMF, Cool & Dry] mode set temperature [Low2] selection		16°C ~ [High2]	
	4	[iAUTO-X/iAUTO/iCOMF, Cool & Dry] mode set temperature [High2] selection		[Low2] ~ 30°C	
	5	Heat mode set temperature Low1 selection		16°C ~ [High1]	
	6	Heat mode set temperature High1 selection		[Low1] ~ 30°C	
	7	Filter cleaning selection		00 – Disable 01 – Enable	
	8	nanoe/nanoe-G default ON selection		00 – Disable 01 – Enable	
	9	Dust sensor monitoring & LED selection		00 – Disable 01 – Enable	
	10	Auto restart selection		00 – Disable 01 – Enable	
	11	Dust sensor sensitivity level adjustment		1, 2, 3	
	12	Auto mode set temperature Low3 selection		16°C ~ [High3]	
	13	Auto mode set temperature High3 selection		[Low3] ~ 30°C	
	14 ~ 49	Reserve			
Service Zone	50	ECO demo ON		None (No display)	
	51	Light sensor check		None (No display)	
	52	nanoe-G / ECO sensor check		None (No display)	
	53	DOA check		None (No display)	
	54	Odor cut control selection		00 – Disable 01 – Enable	
	55	Frequency tolerance selection		03 – ±3Hz 07 – ±7Hz	
	56	Fixed fan speed selection during heat mode compressor OFF		00 – Disable 01 – Enable	
	57	nanoe check		None (No display)	
	58	Heat mode thermo shift adjustment		-3°C ~ 3°C	
	59	Others (Cool & Dry) mode thermo shift adjustment		-3°C ~ 3°C	
	60	Deice start determination judgment temperature switching		00 – No 01 – Yes	
	61	Cool mode disable selection		00 – No 01 – Yes	
	62	Heat mode disable selection		00 – No 01 – Yes	
	63	Base pan heater selection		A – Base pan A b – Base pan B	
	64	Disable fan speed reduction during cool mode thermo-Off		00 – No 01 – Yes	
	65	LED smart OFF selection		00 – Disable 01 – Enable	
	66	nanoe-G ON/OFF duration selection		01 – Pattern 1 02 – Pattern 2 03 – Pattern 3 04 – Pattern 4	
	67	Operation OFF deice function selection		00 – Disable 01 – Enable	
	68	Compressor frequency change speed selection		01 – Pattern 1 02 – Pattern 2 03 – Pattern 3	
	69	Up/Down air swing upper limit restriction selection		00 – Disable 01 – Enable	
70	Failure diagnosis mode disable		None (No display)		
71	Compressor Fhmax setting selection		01 – Offset 1 02 – Offset 2 03 – Offset 3		
72 ~ 99	Reserve				

# 18. Troubleshooting Guide

## 18.1 Refrigeration Cycle System

In order to diagnose malfunctions, make sure that there are no electrical problems before inspecting the refrigeration cycle. Such problems include insufficient insulation, problem with the power source, malfunction of a compressor and a fan. The normal outlet air temperature and pressure of the refrigeration cycle depends on various conditions, the standard values for them are shown in the table on the right.

Normal Pressure and Outlet Air Temperature (Standard)

	Gas Pressure MPa (kg/cm <sup>2</sup> G)	Outlet air Temperature (°C)
Cooling Mode	0.9 ~ 1.2 (9 ~ 12)	13 ~ 17
Heating Mode	2.0 ~ 2.7 (20 ~ 27)	32 ~ 42

- \*Condition:
- Indoor fan speed = High
  - Outdoor temperature 35°C at the cooling mode and 7°C at the heating mode
  - Compressor operates at rated frequency

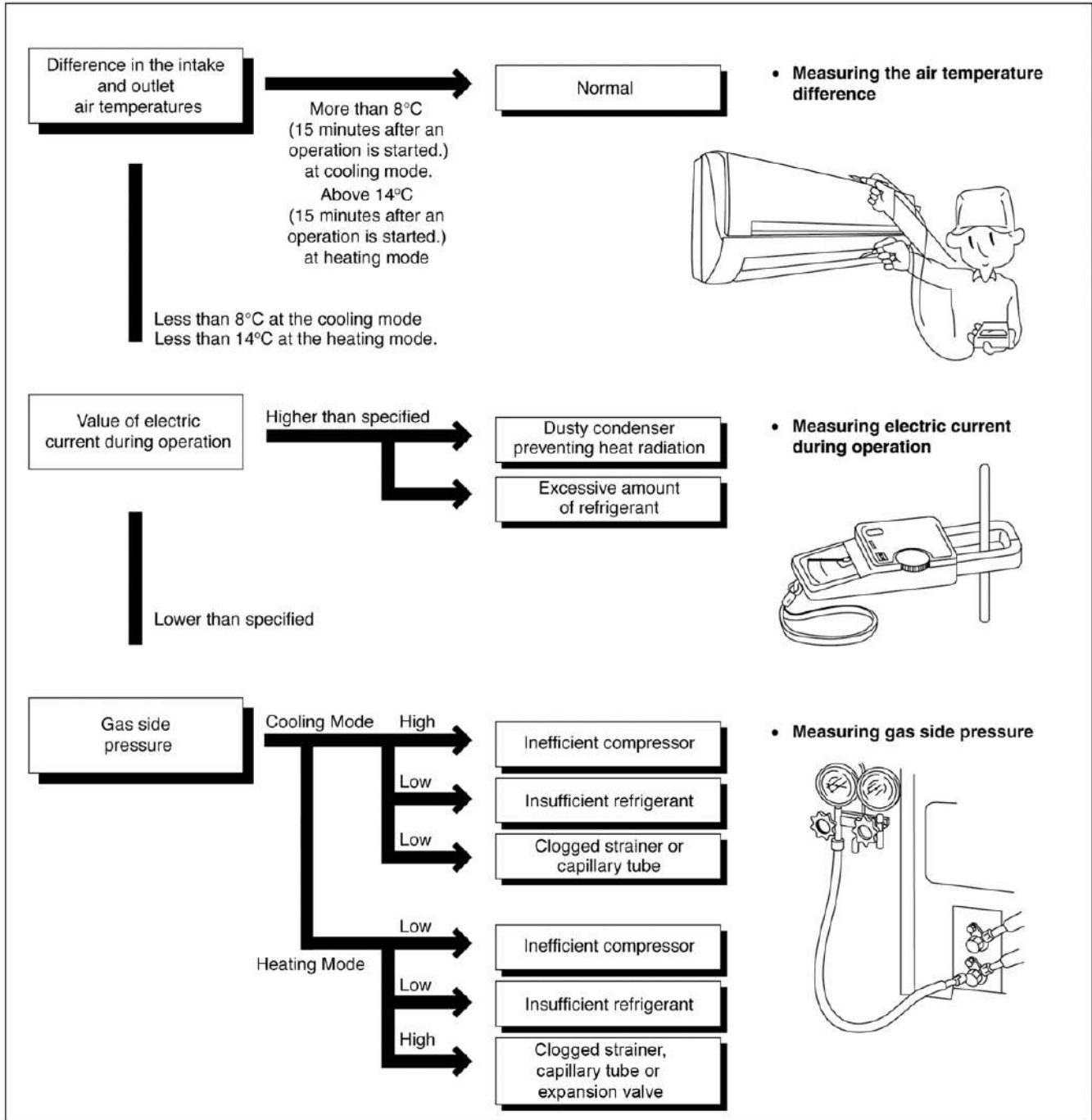

### 18.1.1 Relationship Between the Condition of the Air Conditioner and Pressure and Electric Current

Condition of the air conditioner	Cooling Mode			Heating Mode		
	Low Pressure	High Pressure	Electric current during operation	Low Pressure	High Pressure	Electric current during operation
Insufficient refrigerant (gas leakage)	↘	↘	↘	↘	↘	↘
Clogged capillary tube or Strainer	↘	↘	↘	↗	↗	↗
Short circuit in the indoor unit	↘	↘	↘	↗	↗	↗
Heat radiation deficiency of the outdoor unit	↗	↗	↗	↘	↘	↘
Inefficient compression	↗	↘	↘	↗	↘	↘

- Carry out the measurement of pressure, electric current, and temperature fifteen minutes after an operation is started.

## 18.2 Breakdown Self Diagnosis Function

### 18.2.1 Self Diagnosis Function (Three Digits Alphanumeric Code)

- Once abnormality has occurred during operation, the unit will stop its operation, and Timer LED blinks.
  - Although Timer LED goes off when power supply is turned off, if the unit is operated under a breakdown condition, the LED will light up again.
  - In operation after breakdown repair, the Timer LED will no more blink. The last error code (abnormality) will be stored in IC memory.
- 6 When the latest abnormality code on the main unit and code transmitted from the remote controller are matched, power LED will light up for 30 seconds and a beep sound (continuously for 4 seconds) will be heard. If no codes are matched, power LED will light up for 0.5 seconds and no sound will be heard.
  - 7 The breakdown diagnosis mode will be canceled unless pressing the CHECK button continuously for 5 seconds or operating the unit for 30 seconds.
  - 8 The same diagnosis can be repeated by turning power on again.

### 18.2.2 To Make a Diagnosis

- 1 Timer LED start to blink and the unit automatically stops the operation.
- 2 Press the CHECK button on the remote controller continuously for 5 seconds.
- 3 “- -” will be displayed on the remote controller display.  
Note: Display only for “- -”. (No transmitting signal, no receiving sound and no Power LED blinking.)
- 4 Press the “TIMER” ▲ or ▼ button on the remote controller. The code “H00” (no abnormality) will be displayed and signal will be transmitted to the main unit.
- 5 Every press of the button (up or down) will increase abnormality numbers and transmit abnormality code signal to the main unit.
- 6 When the latest abnormality code on the main unit and code transmitted from the remote controller are matched, power LED will light up for 30 seconds and a beep sound (continuously for 4 seconds) will be heard. If no codes are matched, power LED will light up for 0.5 seconds and no sound will be heard.
- 7 The breakdown diagnosis mode will be canceled unless pressing the CHECK button continuously for 5 seconds or operating the unit for 30 seconds.
- 8 The LED will be off if the unit is turned off or the RESET button on the main unit is pressed.

### 18.2.3 To Display Memorized Error Code (Protective Operation)

- 1 Turn power on.
- 2 Press the CHECK button on the remote controller continuously for 5 seconds.
- 3 “- -” will be displayed on the remote controller display.  
Note: Display only for “- -”. (No transmitting signal, no receiving sound and no Power LED blinking.)
- 4 Press the “TIMER” ▲ or ▼ button on the remote controller. The code “H00” (no abnormality) will be displayed and signal will be transmitted to the main unit. The power LED lights up. If no abnormality is stored in the memory, three beeps sound will be heard.
- 5 Every press of the button (up or down) will increase abnormality numbers and transmit abnormality code signal to the main unit.



### 18.2.4 To Clear Memorized Error Code after Repair (Protective Operation)

- 1 Turn power on (in standby condition).
- 2 Press the AUTO button for 5 seconds (A beep receiving sound) on the main unit to operate the unit at Forced Cooling Operation modes.
- 3 Press the CHECK button on the remote controller for about 1 second with a pointed object to transmit signal to main unit. A beep sound is heard from main unit and the data is cleared.

### 18.2.5 Temporary Operation (Depending On Breakdown Status)

- 1 Press the AUTO button (A beep receiving sound) on the main unit to operate the unit. (Remote control will become possible.)
- 2 The unit can temporarily be used until repaired.

## 18.3 Error Codes Table

Diagnosis display	Abnormality / Protection control	Abnormality Judgment	Protection Operation	Problem	Check location
H00	No memory of failure	—	Normal operation	—	—
H11	Indoor/outdoor abnormal communication	After operation for 1 minute	Indoor fan only operation can start by entering into force cooling operation	Indoor/outdoor communication not establish	<ul style="list-style-type: none"> <li>Indoor/outdoor wire terminal</li> <li>Indoor/outdoor PCB</li> <li>Indoor/outdoor connection wire</li> </ul>
H12	Indoor unit capacity unmatched	90s after power supply	—	Total indoor capability more than maximum limit or less than minimum limit, or number of indoor unit less than two	<ul style="list-style-type: none"> <li>Indoor/outdoor connection wire</li> <li>Indoor/outdoor PCB</li> <li>Specification and combination table in catalogue</li> </ul>
H14	Indoor intake air temperature sensor abnormality	Continuous for 5s	—	Indoor intake air temperature sensor open or short circuit	<ul style="list-style-type: none"> <li>Indoor intake air temperature sensor lead wire and connector</li> </ul>
H15	Compressor temperature sensor abnormality	Continuous for 5s	—	Compressor temperature sensor open or short circuit	<ul style="list-style-type: none"> <li>Compressor temperature sensor lead wire and connector</li> </ul>
H16	Outdoor current transformer (CT) abnormality	—	—	Current transformer faulty or compressor faulty	<ul style="list-style-type: none"> <li>Outdoor PCB faulty or compressor faulty</li> </ul>
H19	Indoor fan motor mechanism lock	Continuous happen for 7 times	—	Indoor fan motor lock or feedback abnormal	<ul style="list-style-type: none"> <li>Fan motor lead wire and connector</li> <li>Fan motor lock or block</li> </ul>
H23	Indoor heat exchanger temperature sensor abnormality	Continuous for 5s	—	Indoor heat exchanger temperature sensor open or short circuit	<ul style="list-style-type: none"> <li>Indoor heat exchanger temperature sensor lead wire and connector</li> </ul>
H24	Indoor heat exchanger temperature sensor 2 abnormality	Continuous for 5s	—	Indoor heat exchanger temperature sensor 2 open or short circuit	<ul style="list-style-type: none"> <li>Indoor heat exchanger temperature sensor 2 lead wire and connector</li> </ul>
H25	Indoor ion device abnormality	Port is ON for 10s during ion device off	—	—	<ul style="list-style-type: none"> <li>ion device PCB</li> </ul>
H27	Outdoor air temperature sensor abnormality	Continuous for 5s	—	Outdoor air temperature sensor open or short circuit	<ul style="list-style-type: none"> <li>Outdoor air temperature sensor lead wire and connector</li> </ul>
H28	Outdoor heat exchanger temperature sensor 1 abnormality	Continuous for 5s	—	Outdoor heat exchanger temperature sensor 1 open or short circuit	<ul style="list-style-type: none"> <li>Outdoor heat exchanger temperature sensor 1 lead wire and connector</li> </ul>
H30	Outdoor discharge pipe temperature sensor abnormality	Continuous for 5s	—	Outdoor discharge pipe temperature sensor open or short circuit	<ul style="list-style-type: none"> <li>Outdoor discharge pipe temperature sensor lead wire and connector</li> </ul>
H32	Outdoor heat exchanger temperature sensor 2 abnormality	Continuous for 5s	—	Outdoor heat exchanger temperature sensor 2 open or short circuit	<ul style="list-style-type: none"> <li>Outdoor heat exchanger temperature sensor 2 lead wire and connector</li> </ul>
H33	Indoor / outdoor misconnection abnormality	—	—	Indoor and outdoor rated voltage different	<ul style="list-style-type: none"> <li>Indoor and outdoor units check</li> </ul>
H34	Outdoor heat sink temperature sensor abnormality	Continuous for 2s	—	Outdoor heat sink temperature sensor open or short circuit	<ul style="list-style-type: none"> <li>Outdoor heat sink sensor</li> </ul>
H36	Outdoor gas pipe temperature sensor abnormality	Continuous for 5s	Heating protection operation only	Outdoor gas pipe temperature sensor open or short circuit	<ul style="list-style-type: none"> <li>Outdoor gas pipe temperature sensor lead wire and connector</li> </ul>
H37	Outdoor liquid pipe temperature sensor abnormality	Continuous for 5s	Cooling protection operation only	Outdoor liquid pipe temperature sensor open or short circuit	<ul style="list-style-type: none"> <li>Outdoor liquid pipe temperature sensor lead wire and connector</li> </ul>
H38	Indoor/Outdoor mismatch (brand code)	—	—	Brand code not match	<ul style="list-style-type: none"> <li>Check indoor unit and outdoor unit</li> </ul>
H39	Abnormal indoor operating unit or standby units	3 times happen within 40 minutes	—	Wrong wiring and connecting pipe, expansion valve abnormality, indoor heat exchanger sensor open circuit	<ul style="list-style-type: none"> <li>Check indoor/outdoor connection wire and connection pipe</li> <li>Indoor heat exchanger sensor lead wire and connector</li> <li>Expansion valve and lead wire and connector</li> </ul>

Diagnosis display	Abnormality / Protection control	Abnormality Judgment	Protection Operation	Problem	Check location
H41	Abnormal wiring or piping connection	—	—	Wrong wiring and connecting pipe, expansion valve abnormality	<ul style="list-style-type: none"> <li>• Check indoor/outdoor connection wire and connection pipe</li> <li>• Expansion valve and lead wire and connector</li> </ul>
H59	ECONAVI sensor abnormality	Continuous for 25s	—	ECONAVI sensor open or short circuit	<ul style="list-style-type: none"> <li>• ECONAVI sensor (defective or disconnected)</li> <li>• ECONAVI PCB</li> </ul>
H64	Outdoor high pressure sensor abnormality	Continuous for 1 minutes	—	High pressure sensor open circuit during compressor stop	<ul style="list-style-type: none"> <li>• High pressure sensor</li> <li>• Lead wire and connector</li> </ul>
H67	Nanoe abnormality	Nanoe stop for 5 minutes for 3 times	—	Nanoe faulty	<ul style="list-style-type: none"> <li>• PCB</li> <li>• Nanoe system</li> <li>• High voltage</li> </ul>
H70	Light sensor abnormality	Continuous for 24 hours, 15 days	—	Light sensor open or short circuit	<ul style="list-style-type: none"> <li>• Light sensor (defective or disconnect)</li> </ul>
H85	Abnormal communication between indoor & wireless LAN module	Communication error for 10 minutes for 3 times	—	Wireless LAN LED Off or timer LED blinking	<ul style="list-style-type: none"> <li>• Network adaptor</li> <li>• Router</li> <li>• Network coverage</li> </ul>
H97	Outdoor fan motor mechanism lock	2 times happen within 30 minutes	—	Outdoor fan motor lock or feedback abnormal	<ul style="list-style-type: none"> <li>• Outdoor fan motor lead wire and connector</li> <li>• Fan motor lock or block</li> </ul>
H98	Indoor high pressure protection	—	—	Indoor high pressure protection (Heating)	<ul style="list-style-type: none"> <li>• Check indoor heat exchanger</li> <li>• Air filter dirty</li> <li>• Air circulation short circuit</li> </ul>
H99	Indoor operating unit freeze protection	—	—	Indoor freeze protection (Cooling)	<ul style="list-style-type: none"> <li>• Check indoor heat exchanger</li> <li>• Air filter dirty</li> <li>• Air circulation short circuit</li> </ul>
F11	4-way valve switching abnormality	4 times happen within 30 minutes	—	4-way valve switching abnormal	<ul style="list-style-type: none"> <li>• 4-way valve</li> <li>• Lead wire and connector</li> </ul>
F17	Indoor standby units freezing abnormality	3 times happen within 40 minutes	—	Wrong wiring and connecting pipe, expansion valve leakage, indoor heat exchanger sensor open circuit	<ul style="list-style-type: none"> <li>• Check indoor/outdoor connection wire and pipe</li> <li>• Indoor heat exchanger sensor lead wire and connector</li> <li>• Expansion valve lead wire and connector</li> </ul>
F90	Power factor correction (PFC) circuit protection	4 times happen within 10 minutes	—	Power factor correction circuit abnormal	<ul style="list-style-type: none"> <li>• Outdoor PCB faulty</li> </ul>
F91	Refrigeration cycle abnormality	2 times happen within 20 minutes	—	Refrigeration cycle abnormal	<ul style="list-style-type: none"> <li>• Insufficient refrigerant or valve close</li> </ul>
F93	Compressor abnormal revolution	4 times happen within 20 minutes	—	Compressor abnormal revolution	<ul style="list-style-type: none"> <li>• Power transistor module faulty or compressor lock</li> </ul>
F94	Compressor discharge overshoot protection	4 times happen within 30 minutes	—	Compressor discharge pressure overshoot	<ul style="list-style-type: none"> <li>• Check refrigeration system</li> </ul>
F95	Outdoor cooling high pressure protection	4 times happen within 20 minutes	—	Cooling high pressure protection	<ul style="list-style-type: none"> <li>• Check refrigeration system</li> <li>• Outdoor air circuit</li> </ul>
F96	Power transistor module overheating protection	4 times happen within 30 minutes	—	Power transistor module overheat	<ul style="list-style-type: none"> <li>• PCB faulty</li> <li>• Outdoor air circuit (fan motor)</li> </ul>
F97	Compressor overheating protection	3 times happen within 30 minutes	—	Compressor overheat	<ul style="list-style-type: none"> <li>• Insufficient refrigerant</li> </ul>
F98	Total running current protection	3 times happen within 20 minutes	—	Total current protection	<ul style="list-style-type: none"> <li>• Check refrigeration system</li> <li>• Power source or compressor lock</li> </ul>
F99	Outdoor direct current (DC) peak detection	Continuous happen for 7 times	—	Power transistor module current protection	<ul style="list-style-type: none"> <li>• Power transistor module faulty or compressor lock</li> </ul>

## 18.4 Self-diagnosis Method

### 18.4.1 H11 (Indoor/Outdoor Abnormal Communication)

#### Malfunction Decision Conditions

- During startup and operation of cooling and heating, the data received from outdoor unit in indoor unit signal transmission is checked whether it is normal.

#### Malfunction Caused

- Faulty indoor unit PCB.
- Faulty outdoor unit PCB.
- Indoor unit-outdoor unit signal transmission error due to wiring error.
- Indoor unit-outdoor unit signal transmission error due to breaking of wire in the connection wires between the indoor and outdoor units.

#### Troubleshooting

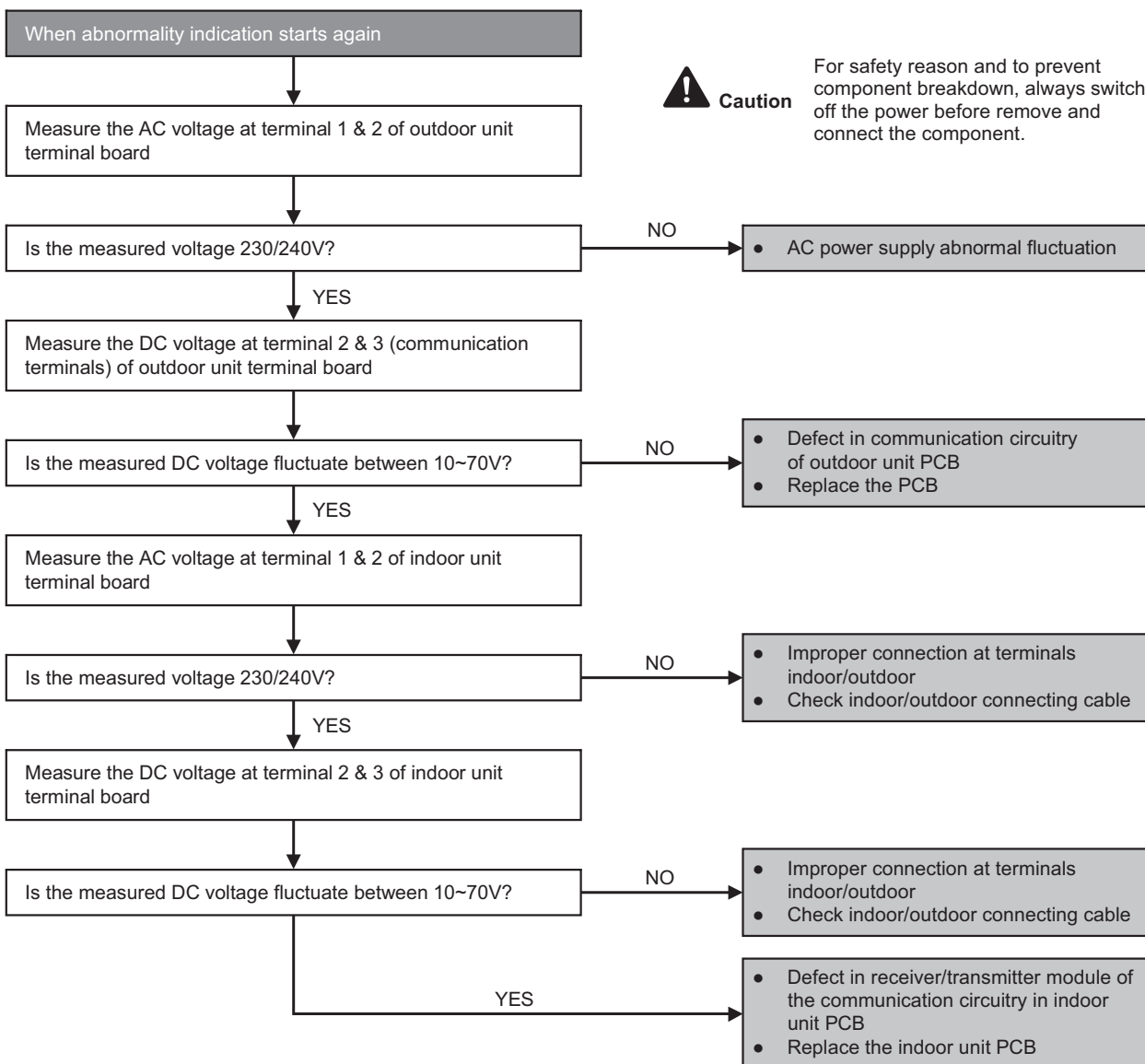

## 18.4.2 H12 (Indoor/Outdoor Capacity Rank Mismatched)

### Malfunction Decision Conditions

- During startup, error code appears when different types of indoor and outdoor units are interconnected.

### Malfunction Caused

- Wrong models interconnected.
- Wrong indoor unit or outdoor unit PCBs mounted.
- Indoor unit or outdoor unit PCBs defective.
- Indoor-outdoor unit signal transmission error due to wrong wiring.
- Indoor-outdoor unit signal transmission error due to breaking of wire 3 in the connection wires between the indoor and outdoor units.

### Troubleshooting

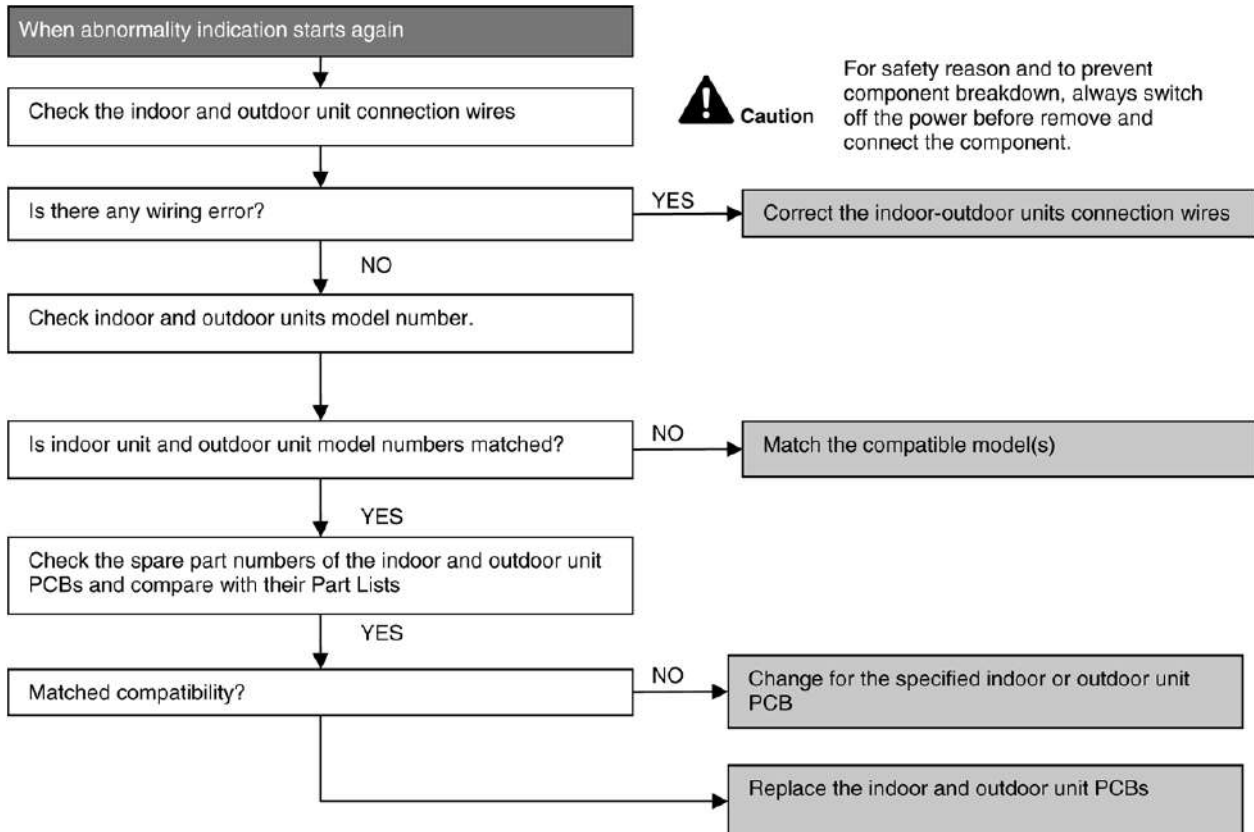

### 18.4.3 H14 (Indoor Intake Air Temperature Sensor Abnormality)

#### Malfunction Decision Conditions

- During startup and operation of cooling and heating, the temperatures detected by the indoor intake air temperature sensor are used to determine sensor errors.

#### Malfunction Caused

- Faulty connector connection.
- Faulty sensor.
- Faulty PCB.

#### Troubleshooting

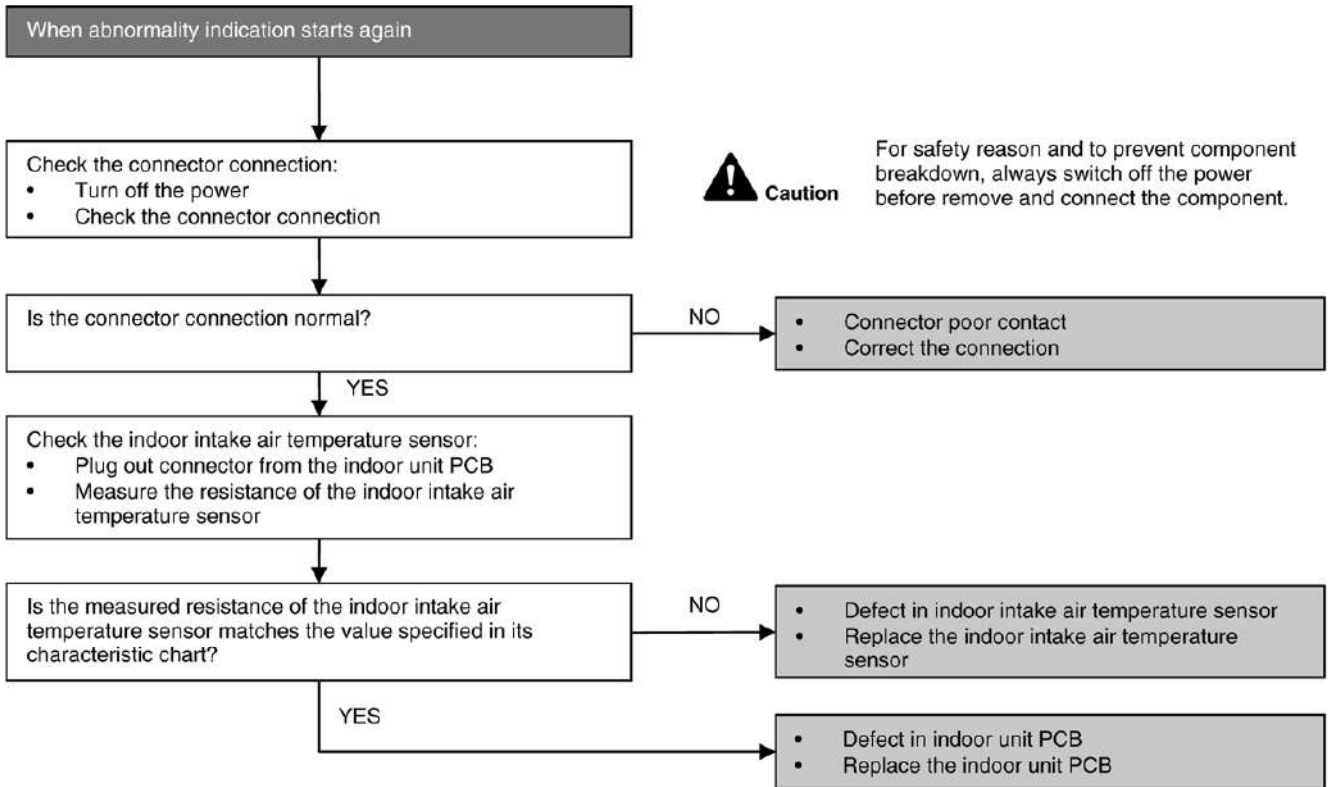

**Caution** For safety reason and to prevent component breakdown, always switch off the power before remove and connect the component.

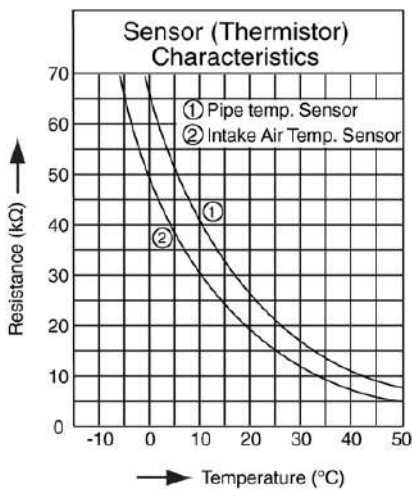

## 18.4.4 H15 (Compressor Temperature Sensor Abnormality)

### Malfunction Decision Conditions

- During startup and operation of cooling and heating, the temperatures detected by the outdoor compressor temperature sensor are used to determine sensor errors.

### Malfunction Caused

- Faulty connector connection.
- Faulty sensor.
- Faulty PCB.

### Troubleshooting

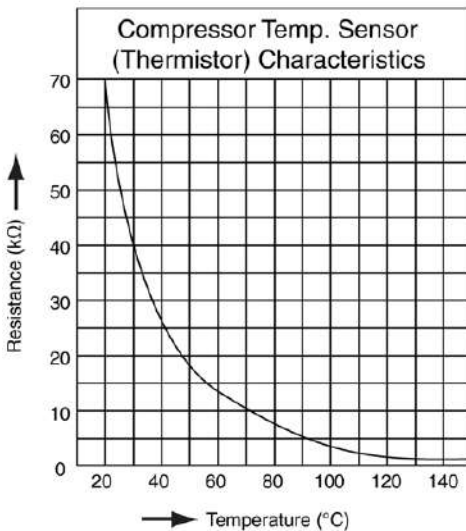
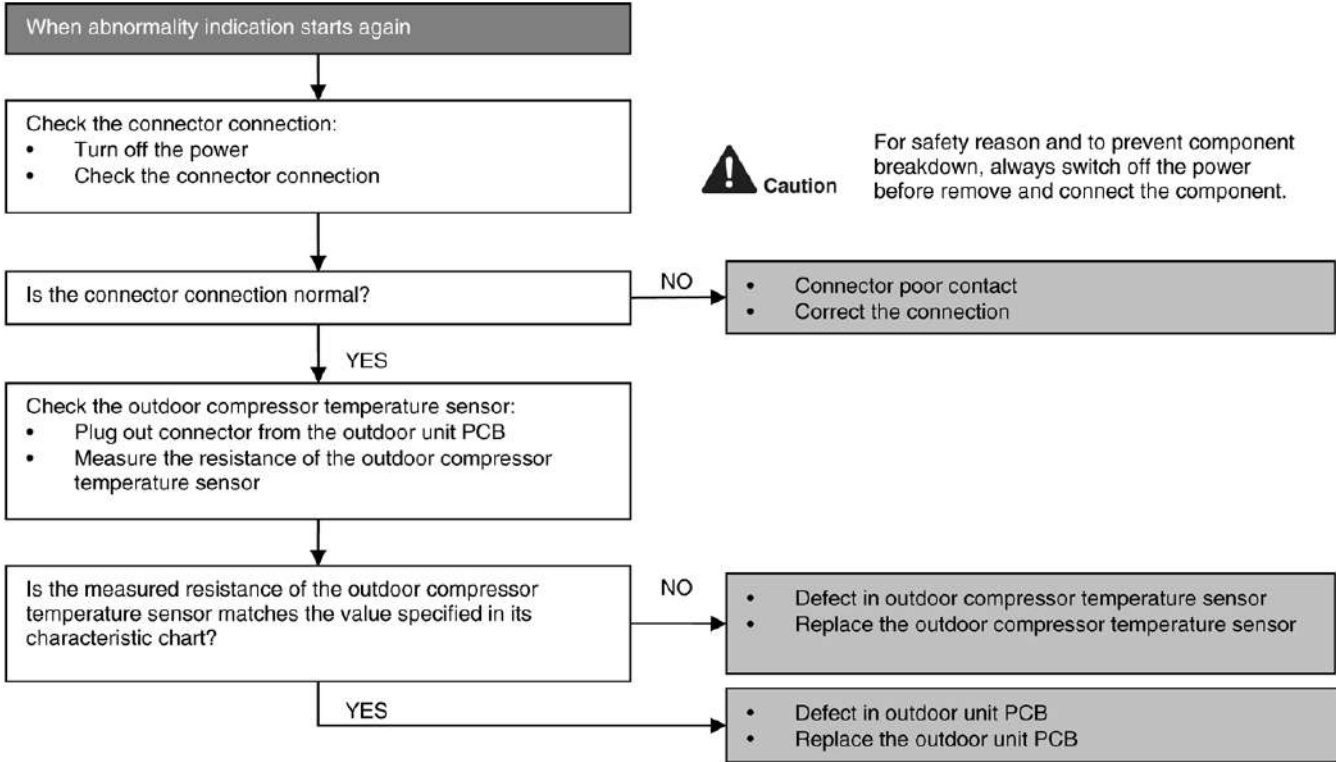

### 18.4.5 H16 (Outdoor Current Transformer)

#### Malfunction Decision Conditions

- An input current, detected by Current Transformer CT, is below threshold value when the compressor is operating at certain frequency value for 3 minutes.

#### Malfunction Caused

- Lack of gas
- Broken CT (current transformer)
- Broken Outdoor PCB

#### Troubleshooting

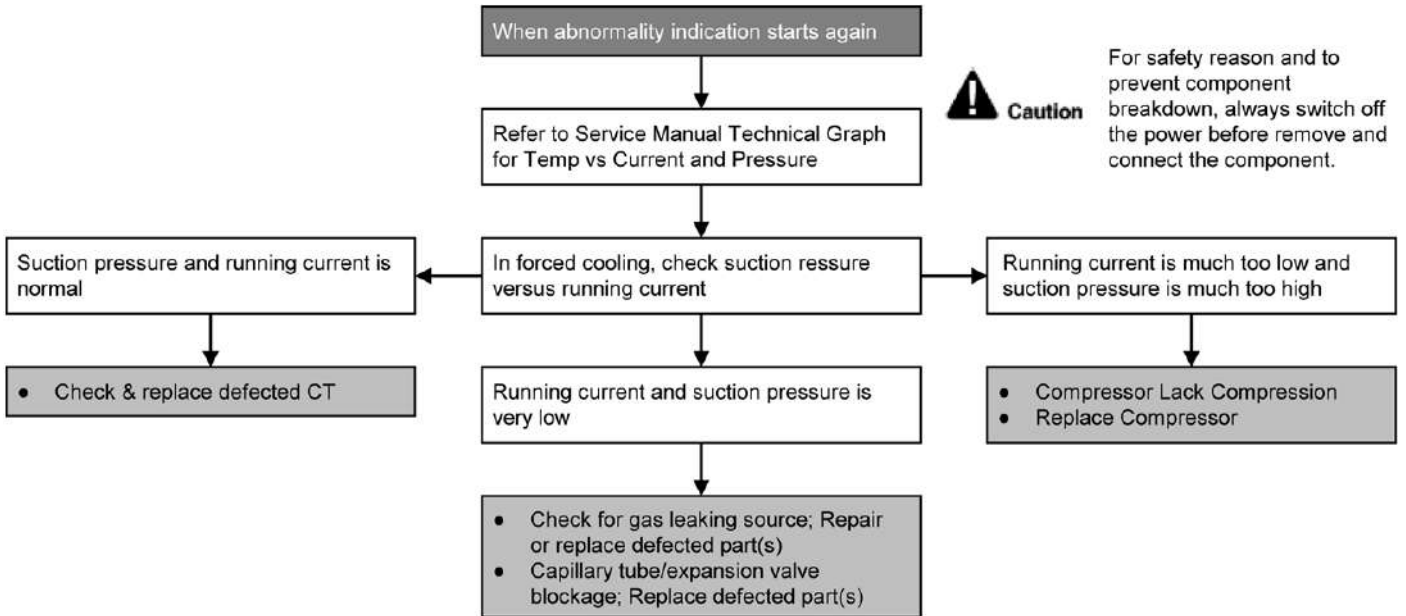

## 18.4.6 H19 (Indoor Fan Motor – DC Motor Mechanism Locked)

### Malfunction Decision Conditions

- The rotation speed detected by the Hall IC during fan motor operation is used to determine abnormal fan motor (feedback of rotation > 2550 rpm or < 50 rpm)

### Malfunction Caused

- Operation stops due to short circuit inside the fan motor winding.
- Operation stops due to breaking of wire inside the fan motor.
- Operation stops due to breaking of fan motor lead wires.
- Operation stops due to Hall IC malfunction.
- Operation error due to faulty indoor unit PCB.

### Troubleshooting

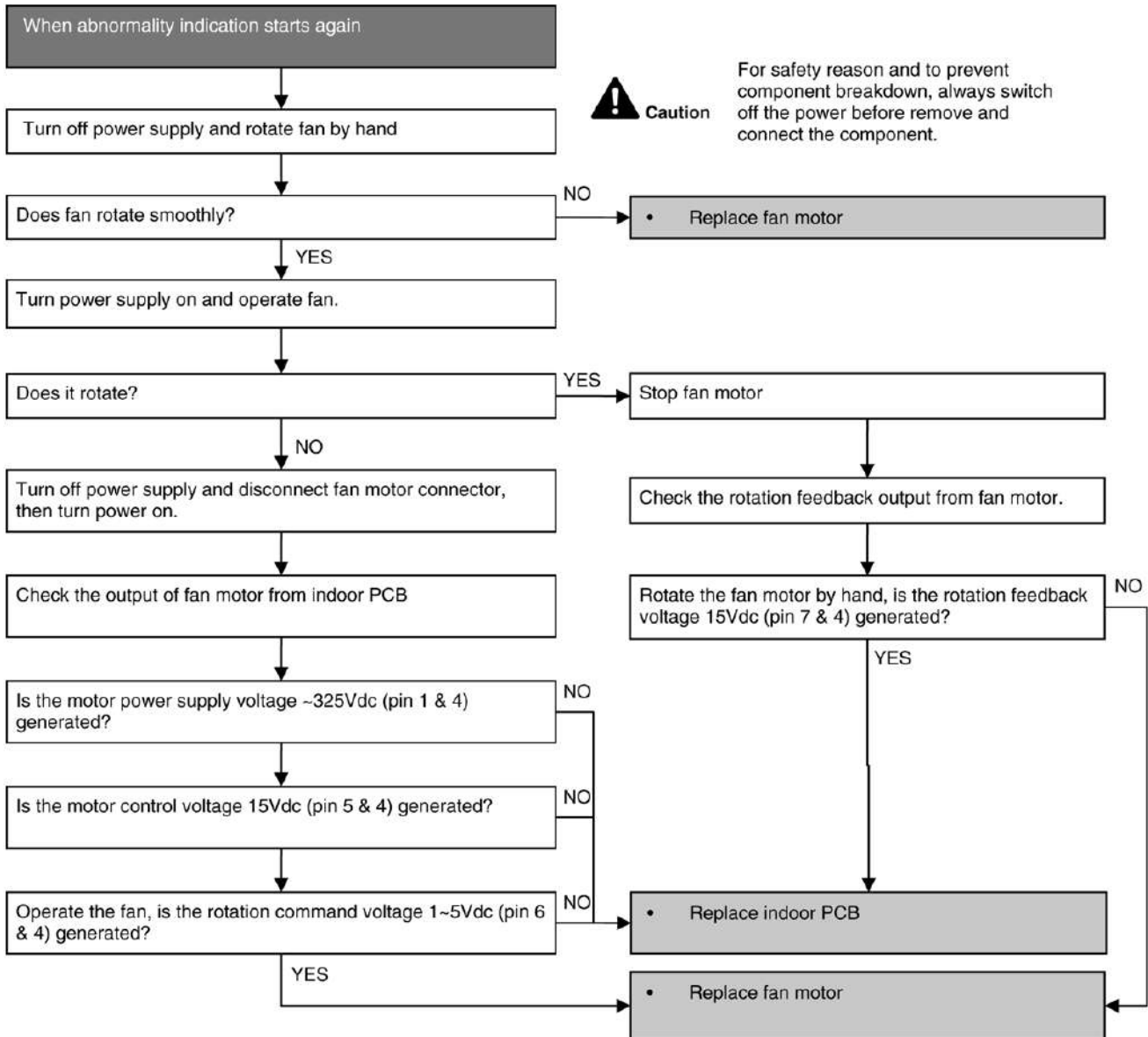

## 18.4.7 H23 (Indoor Pipe Temperature Sensor Abnormality)

### Malfunction Decision Conditions

- During startup and operation of cooling and heating, the temperatures detected by the indoor heat exchanger temperature sensor are used to determine sensor errors.

### Malfunction Caused

- Faulty connector connection.
- Faulty sensor.
- Faulty PCB.

### Troubleshooting

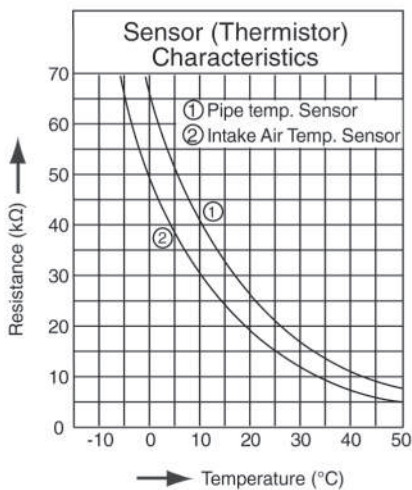
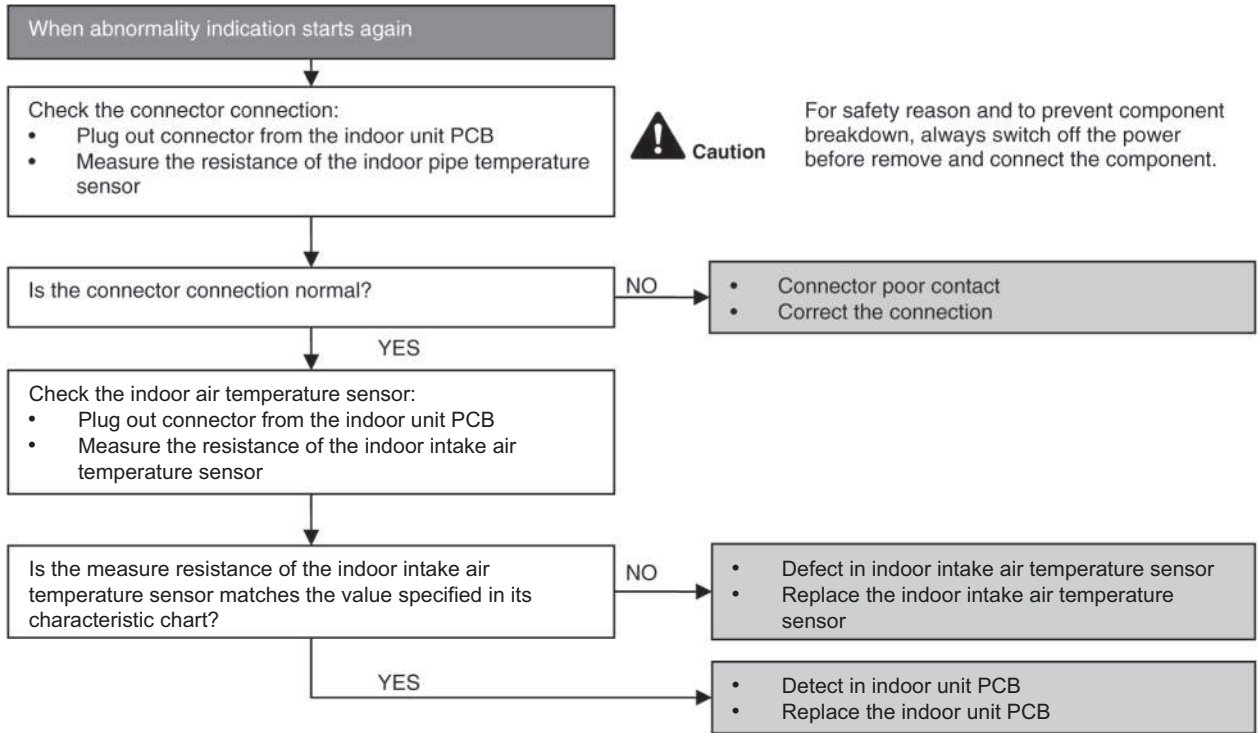

## 18.4.8 H27 (Outdoor Air Temperature Sensor Abnormality)

### Malfunction Decision Conditions

- During startup and operation of cooling and heating, the temperatures detected by the outdoor air temperature sensor are used to determine sensor errors.

### Malfunction Caused

- Faulty connector connection.
- Faulty sensor.
- Faulty PCB.

### Troubleshooting

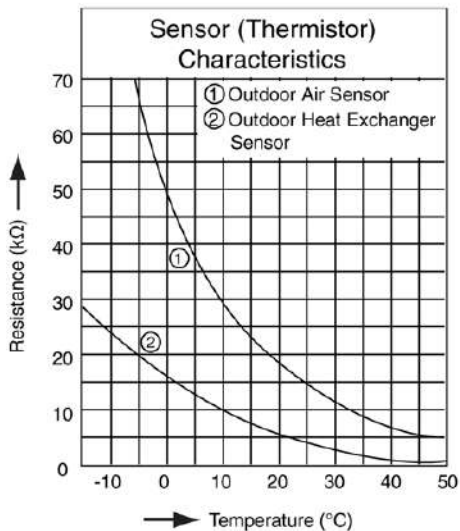
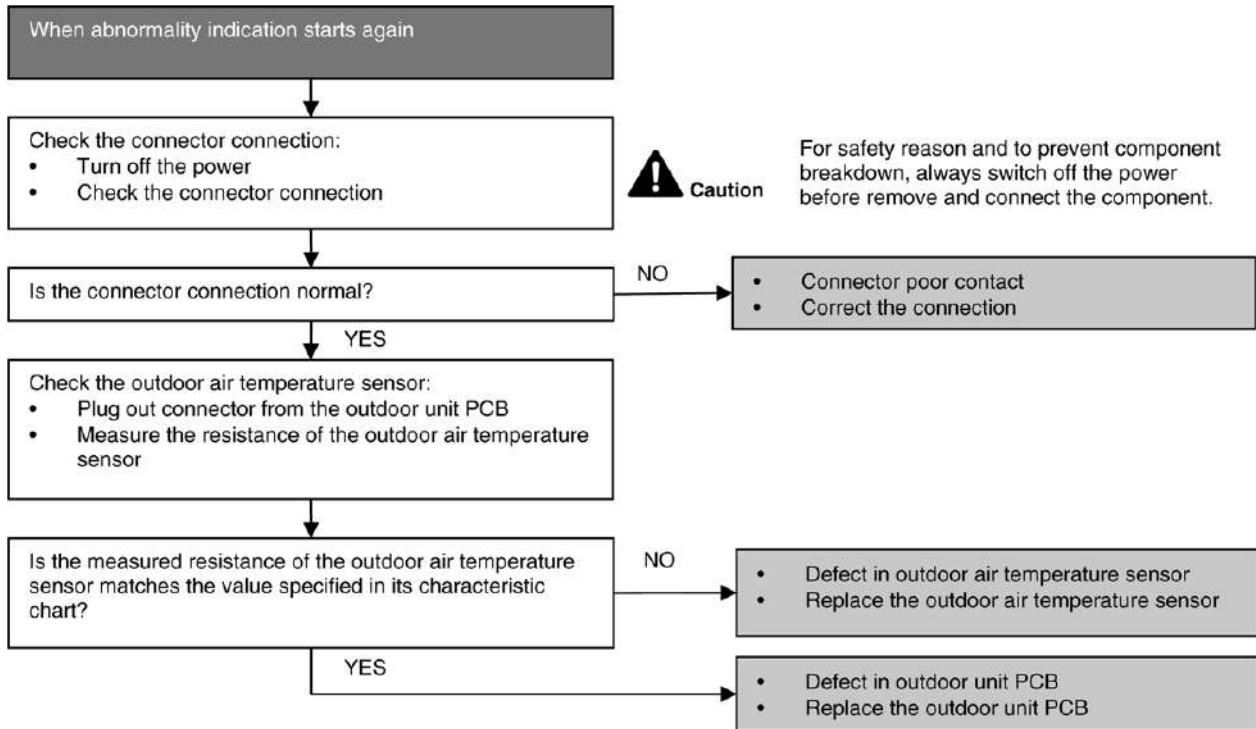

### 18.4.9 H28 (Outdoor Pipe Temperature Sensor Abnormality)

#### Malfunction Decision Conditions

- During startup and operation of cooling and heating, the temperatures detected by the outdoor pipe temperature sensor are used to determine sensor errors.

#### Malfunction Caused

- Faulty connector connection.
- Faulty sensor.
- Faulty PCB.

#### Troubleshooting

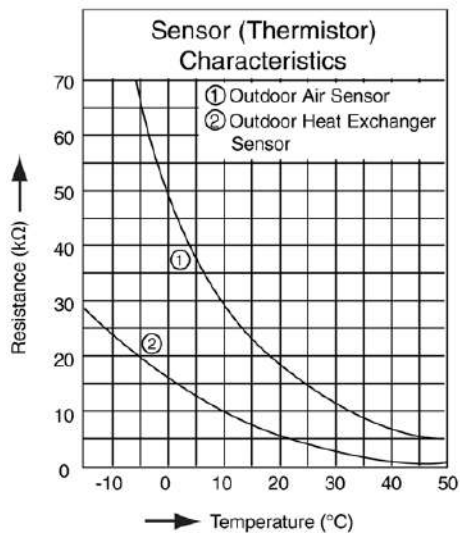
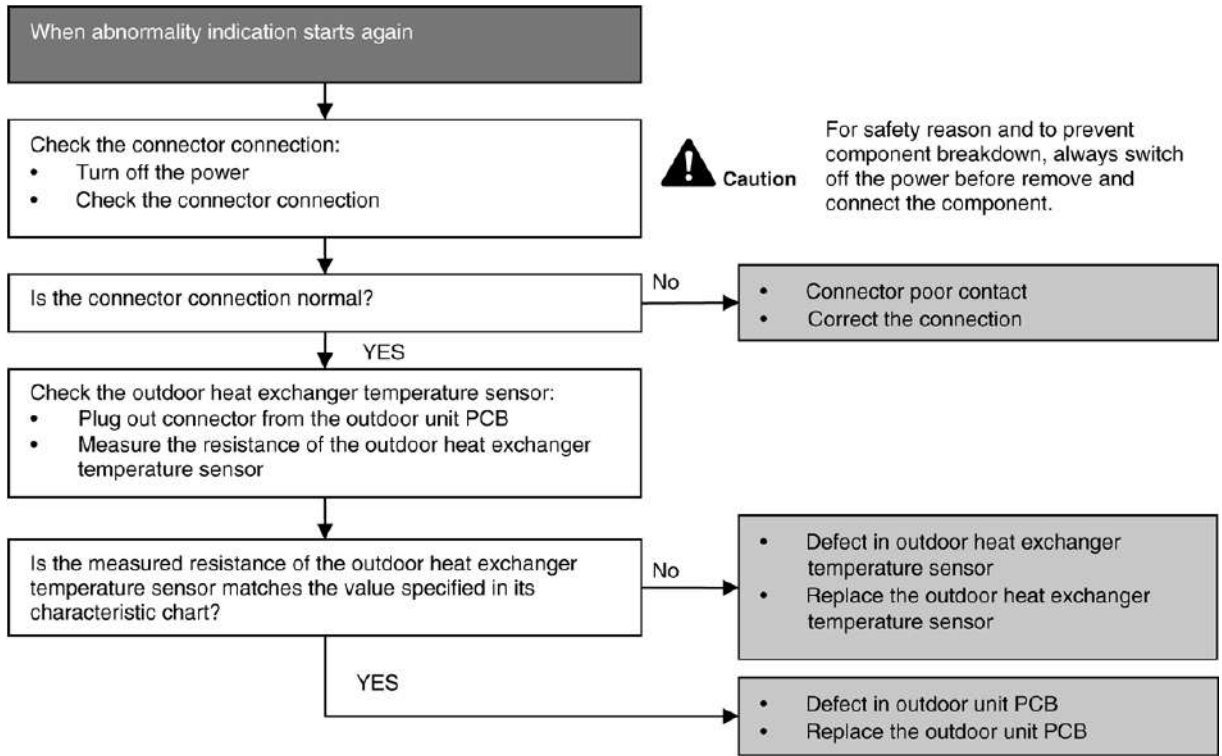

## 18.4.10 H30 (Compressor Discharge Temperature Sensor Abnormality)

### Malfunction Decision Conditions

- During startup and operation of cooling and heating, the temperatures detected by the outdoor discharge pipe temperature sensor are used to determine sensor errors.

### Malfunction Caused

- Faulty connector connection.
- Faulty sensor.
- Faulty PCB.

### Troubleshooting

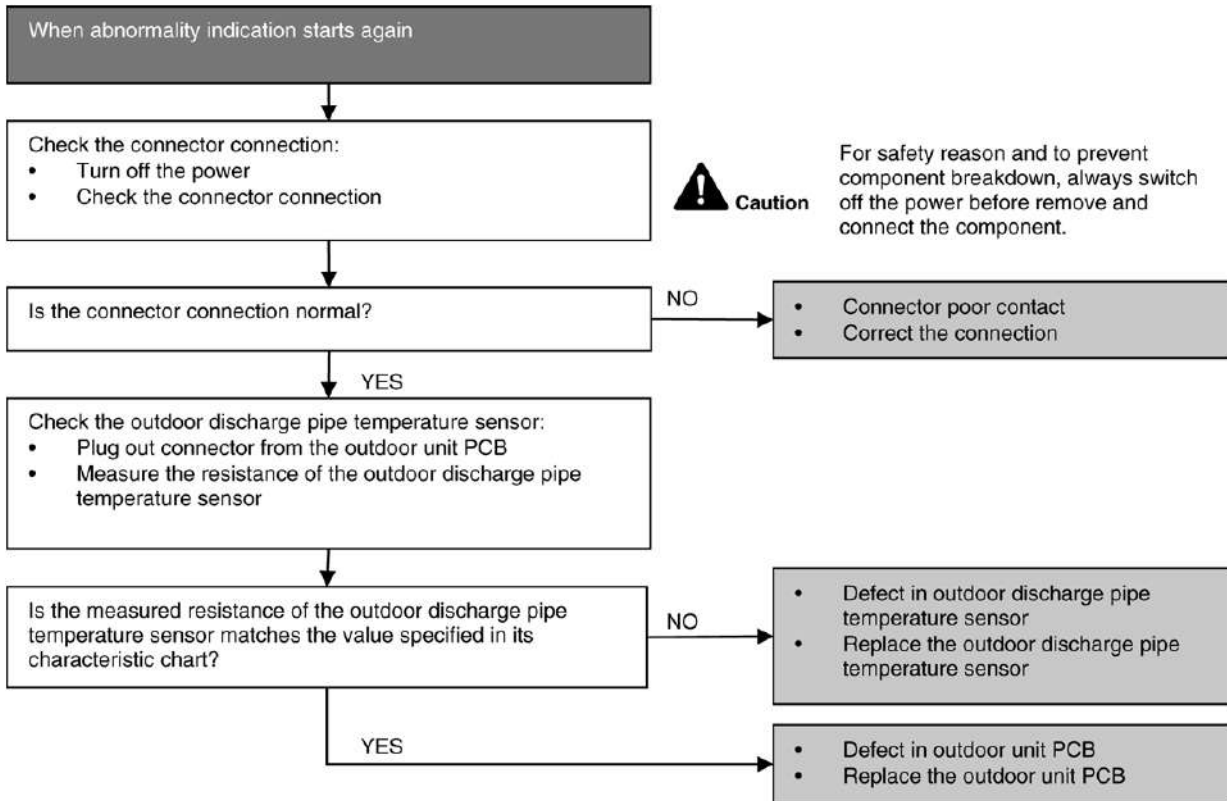

### 18.4.11 H32 (Outdoor Heat Exchanger Temperature Sensor 2 Abnormality)

#### Malfunction Decision Conditions

- During startup and operation of cooling and heating, the temperatures detected by the outdoor heat exchanger temperature sensor are used to determine sensor errors.

#### Malfunction Caused

- Faulty connector connection.
- Faulty sensor.
- Faulty PCB.

#### Troubleshooting

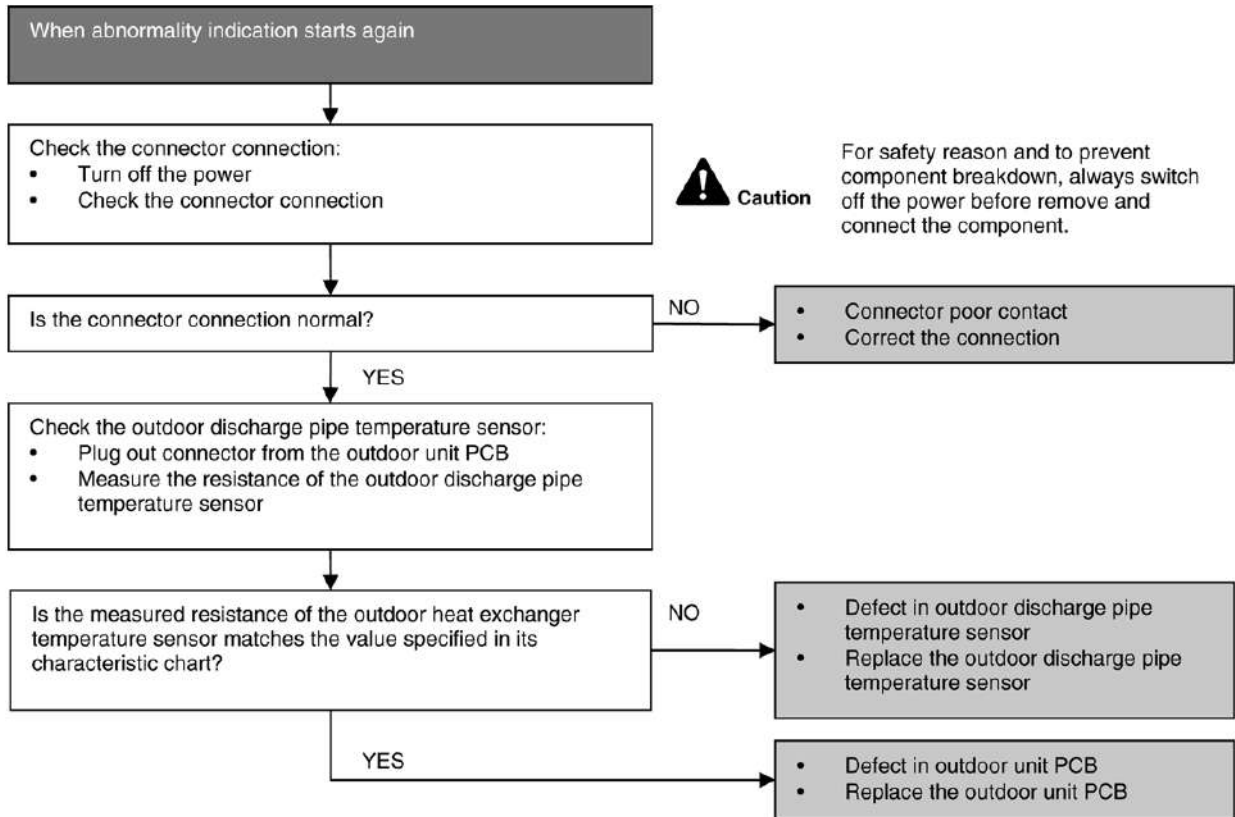

## 18.4.12 H33 (Unspecified Voltage between Indoor and Outdoor)

### Malfunction Decision Conditions

- The supply power is detected for its requirement by the indoor/outdoor transmission.

### Malfunction Caused

- Wrong models interconnected.
- Wrong indoor unit and outdoor unit PCBs used.
- Indoor unit or outdoor unit PCB defective.

### Troubleshooting

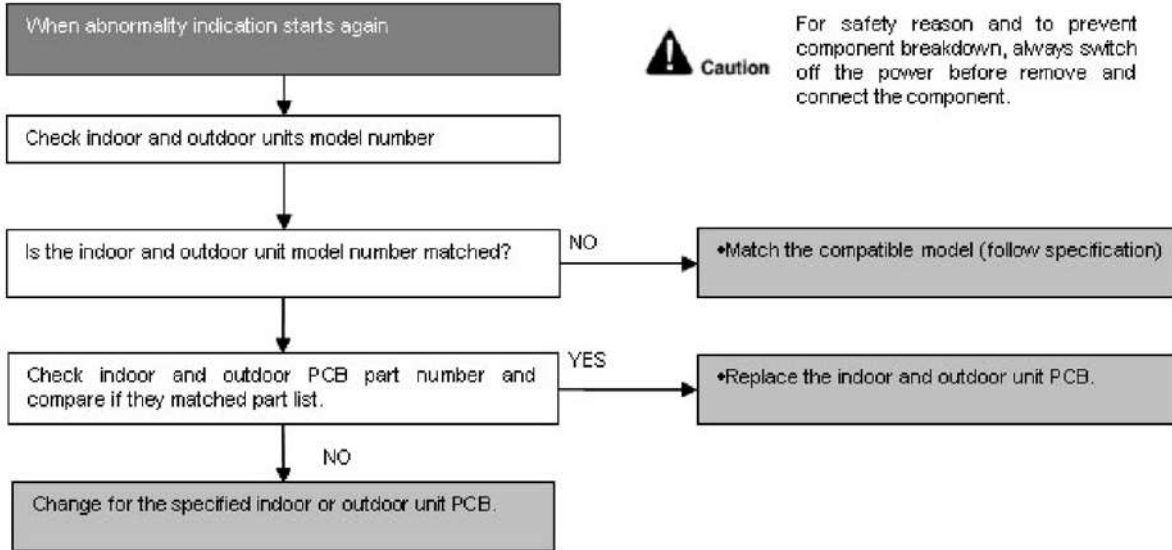

### 18.4.13 H34 (Outdoor Heat Sink Temperature Sensor Abnormality)

#### Malfunction Decision Conditions

- During startup and operation of cooling and heating, the temperatures detected by the outdoor heat sink temperature sensor are used to determine sensor errors.

#### Malfunction Caused

- Faulty connector connection.
- Faulty sensor.
- Faulty PCB.

#### Troubleshooting

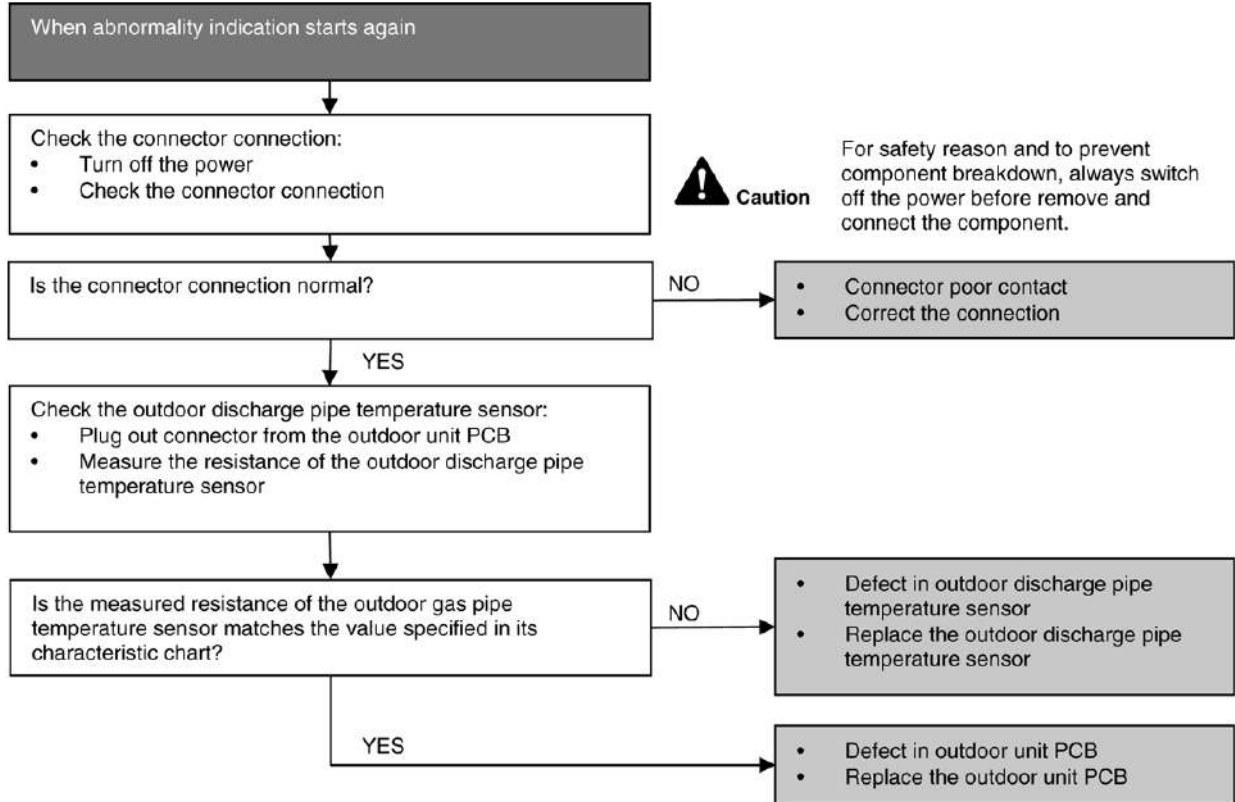

## 18.4.14 H36 (Outdoor Gas Pipe Sensor Abnormality)

### Malfunction Decision Conditions

- During startup and operation of cooling and heating, the temperatures detected by the outdoor gas pipe temperature sensor are used to determine sensor errors.

### Malfunction Caused

- Faulty connector connection.
- Faulty sensor.
- Faulty PCB.

### Troubleshooting

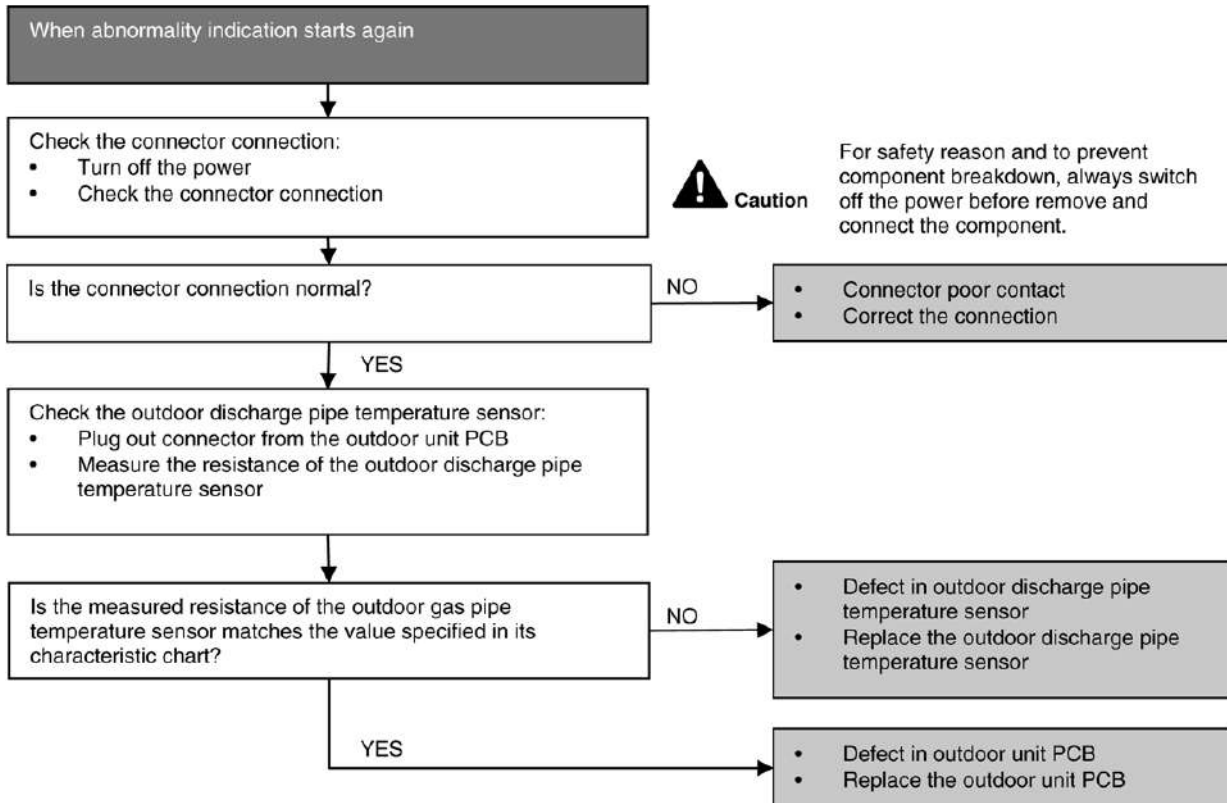

### 18.4.15 H37 (Outdoor Liquid Pipe Temperature Sensor Abnormality)

#### Malfunction Decision Conditions

- During startup and operation of cooling and heating, the temperatures detected by the outdoor liquid pipe temperature sensor are used to determine sensor errors.

#### Malfunction Caused

- Faulty connector connection.
- Faulty sensor.
- Faulty PCB.

#### Troubleshooting

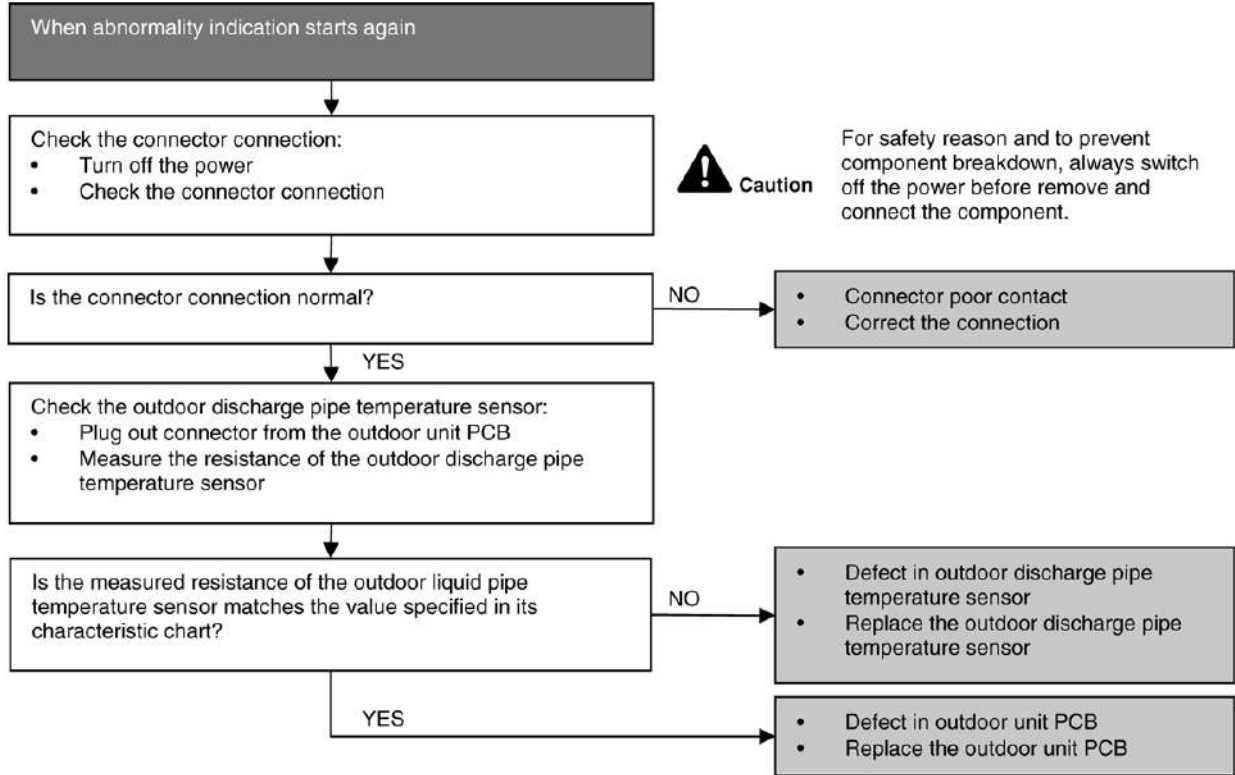

## 18.4.16 H97 (Outdoor Fan Motor – DC Motor Mechanism Locked)

### Malfunction Decision Conditions

- The rotation speed detected by the Hall IC during fan motor operation is used to determine abnormal fan motor.

### Malfunction Caused

- Operation stops due to short circuit inside the fan motor winding.
- Operation stops due to breaking of wire inside the fan motor.
- Operation stops due to breaking of fan motor lead wires.
- Operation stops due to Hall IC malfunction.
- Operation error due to faulty outdoor unit PCB.

### Troubleshooting

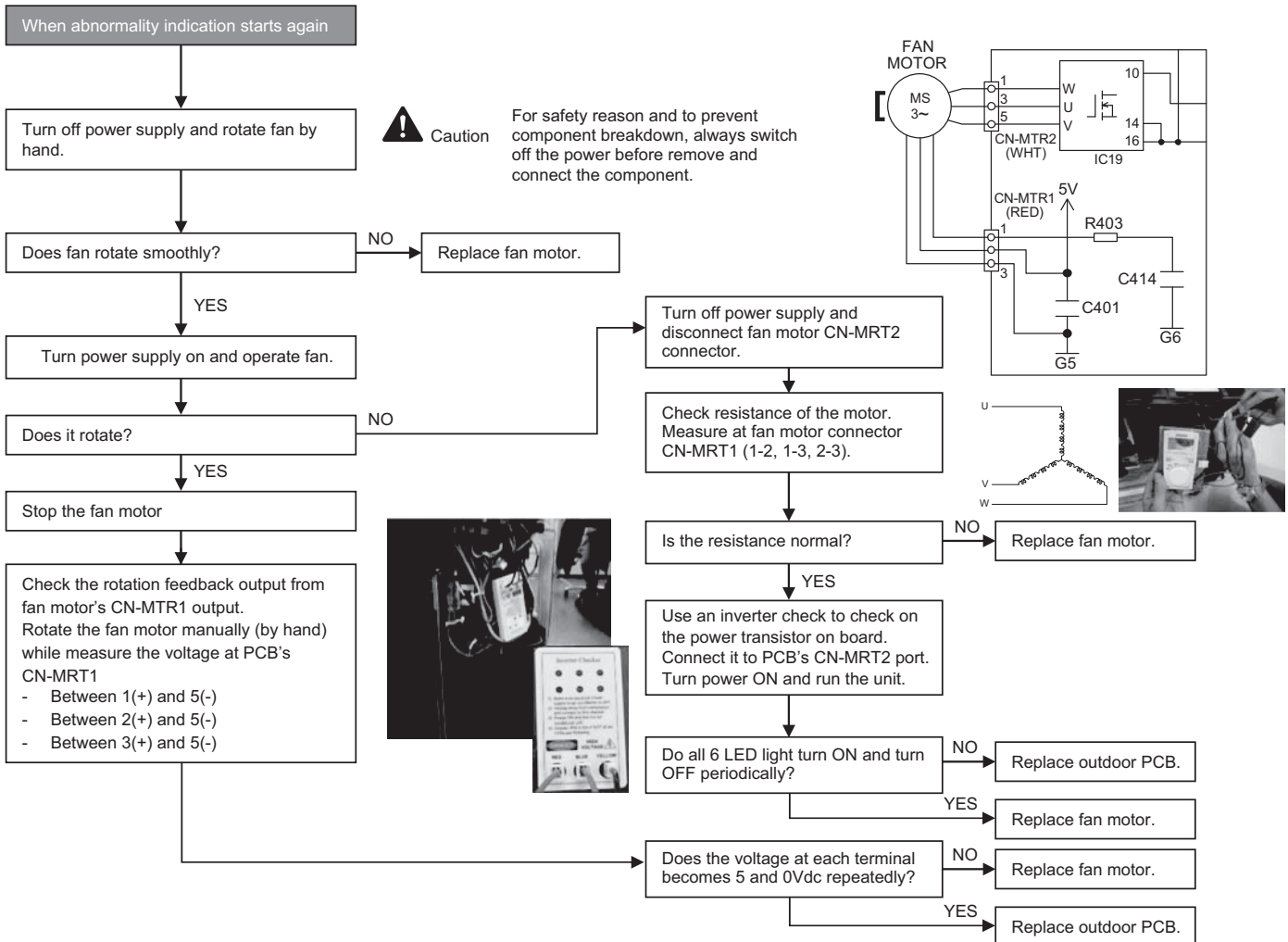

## 18.4.17 H98 (Error Code Stored in Memory and no alarm is triggered / no TIMER LED flashing)

### Malfunction Decision Conditions

- Indoor high pressure is detected when indoor heat exchanger is detecting very high temperature when the unit is operating in heating operation.
- Phenomena: unit is stopping and re-starting very often in heating mode

### Malfunction Caused

- Indoor heat exchanger thermistor
- Clogged air filter or heat exchanger
- Over-bent pipe (liquid side)

### Troubleshooting

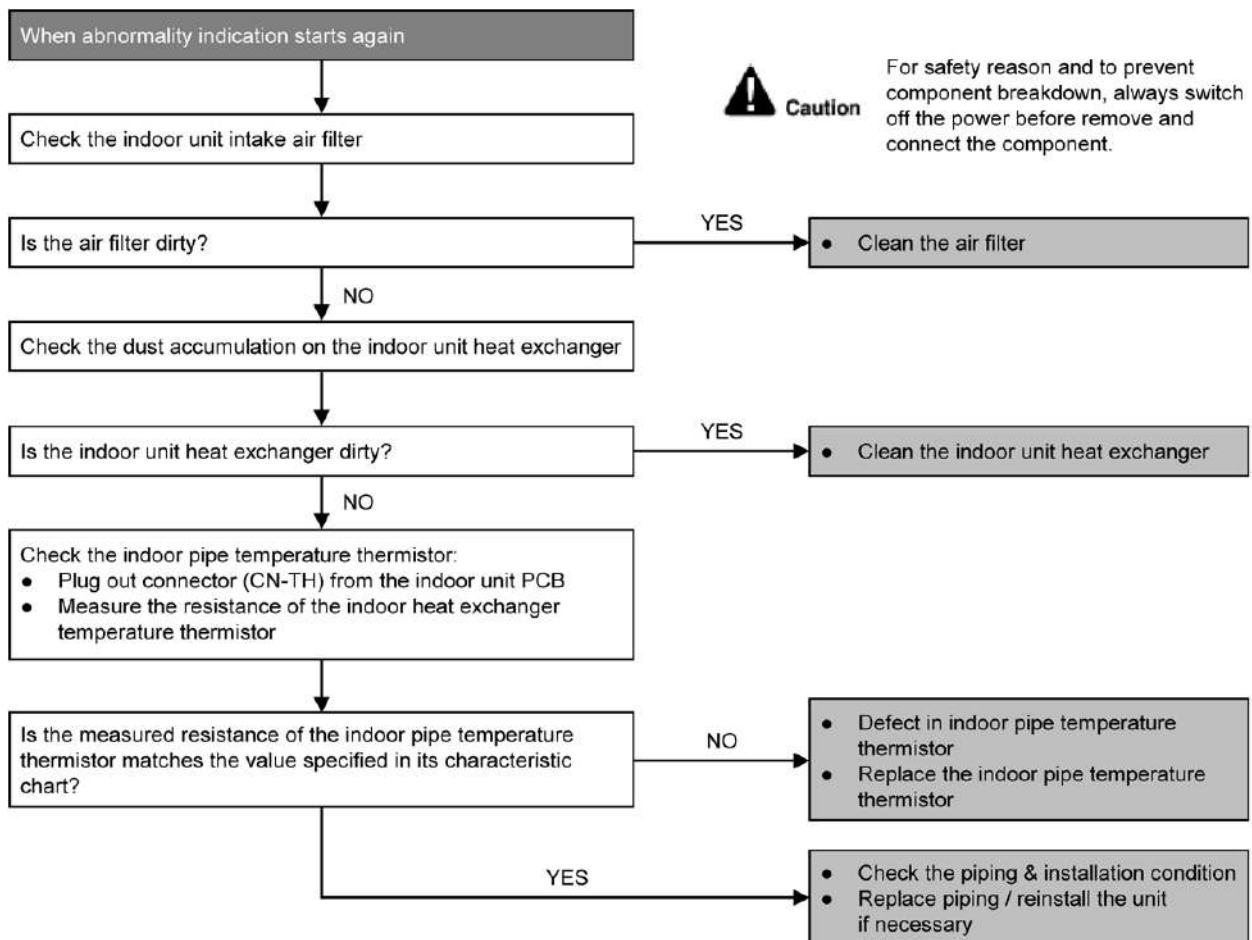

## 18.4.18 H99 (Indoor Freeze Prevention Protection: Cooling or Soft Dry)

Error Code will not display (no Timer LED blinking) but store in EEPROM

### Malfunction Decision Conditions

- Freeze prevention control takes place (when indoor pipe temperature is lower than 2°C)

### Malfunction Caused

- Air short circuit at indoor unit
- Clogged indoor unit air filter
- Dust accumulation on the indoor unit heat exchanger
- 2/3 way valve closed
- Faulty indoor unit fan motor
- Refrigerant shortage (refrigerant leakage)
- Clogged expansion valve or strainer
- Faulty indoor pipe temperature sensor
- Faulty indoor unit PCB

### Troubleshooting

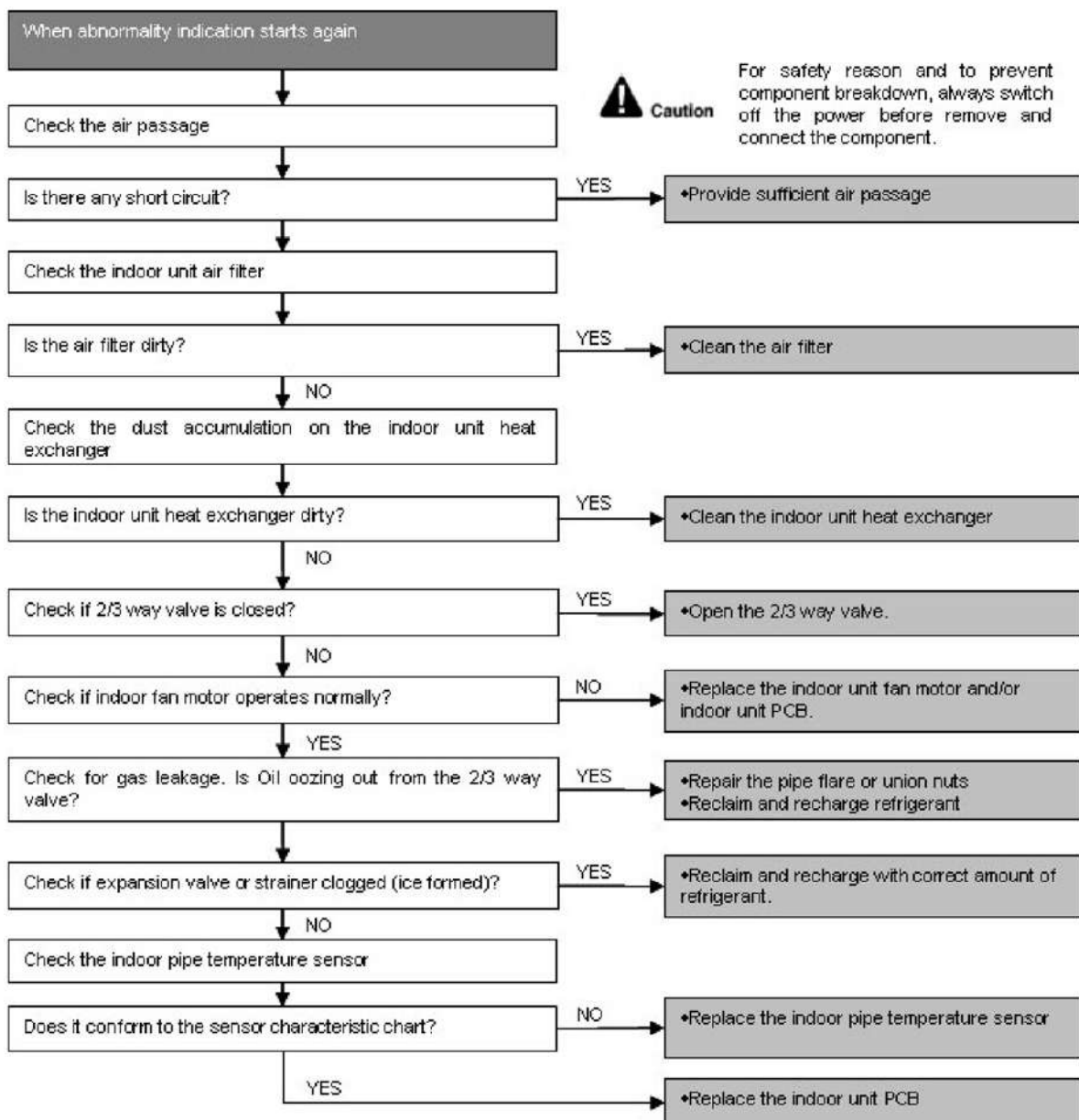

## 18.4.19 F11 (4-way Valve Switching Failure)

### Malfunction Decision Conditions

- When indoor heat exchanger is cold during heating (except deice) or when indoor heat exchanger is hot during cooling and compressor operating, the 4-way valve is detected as malfunction.

### Malfunction Caused

- Indoor heat exchanger (pipe) thermistor
- 4-way valve malfunction

### Troubleshooting

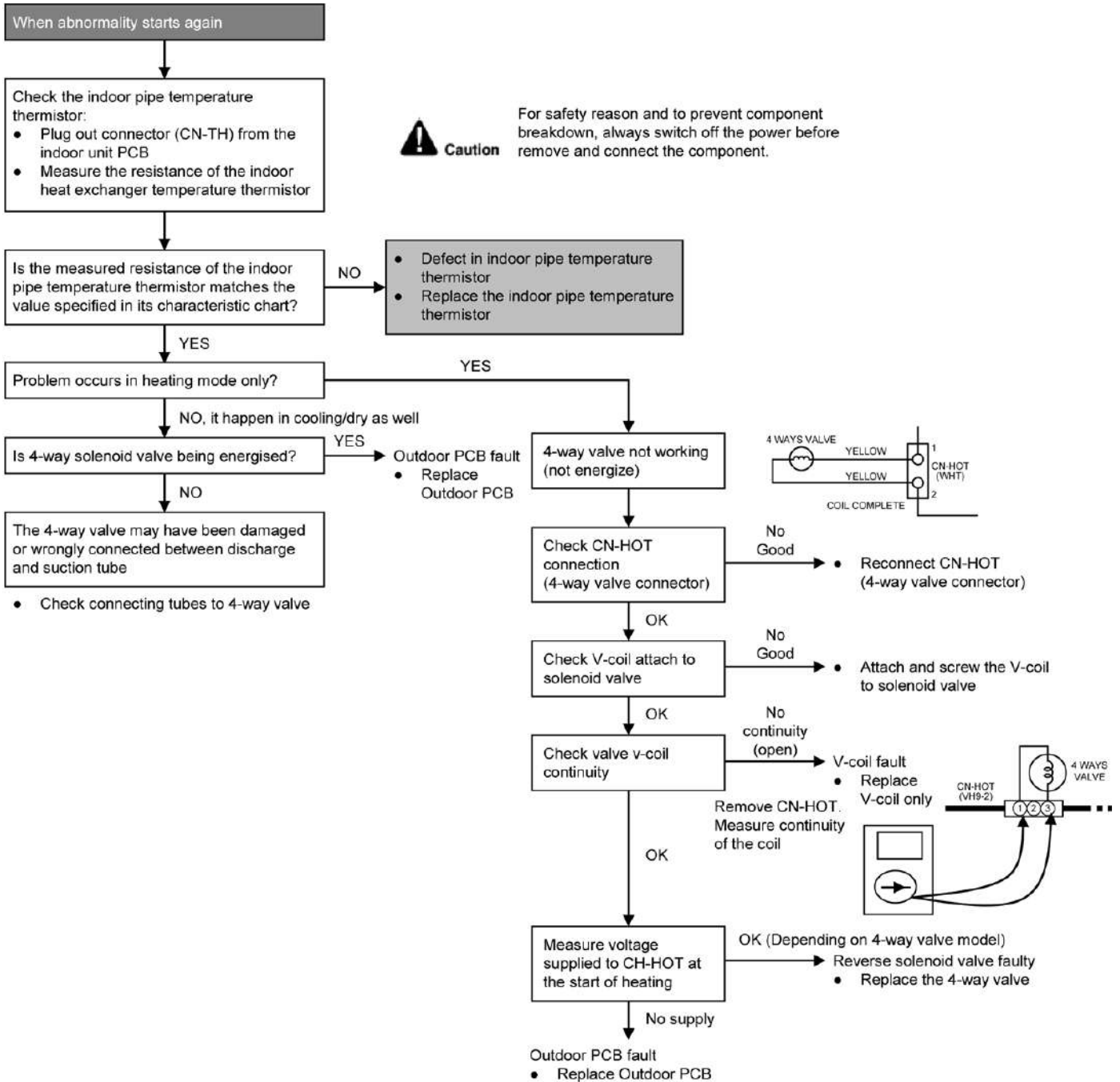

\* Check gas side pipe – for hot gas flow in cooling mode

## 18.4.20 F17 (Indoor Standby Units Freezing Abnormality)

### Malfunction Decision Conditions

- When the different between indoor intake air temperature and indoor pipe temperature is above 10°C or indoor pipe temperature is below -1.0°C.

### Remark:

When the indoor standby unit is freezing, the outdoor unit transfers F17 error code to the corresponding indoor unit and H39 to other indoor unit(s).

### Malfunction Caused

- Wrong wiring connection
- Faulty sensor
- Faulty expansion valve

### Troubleshooting

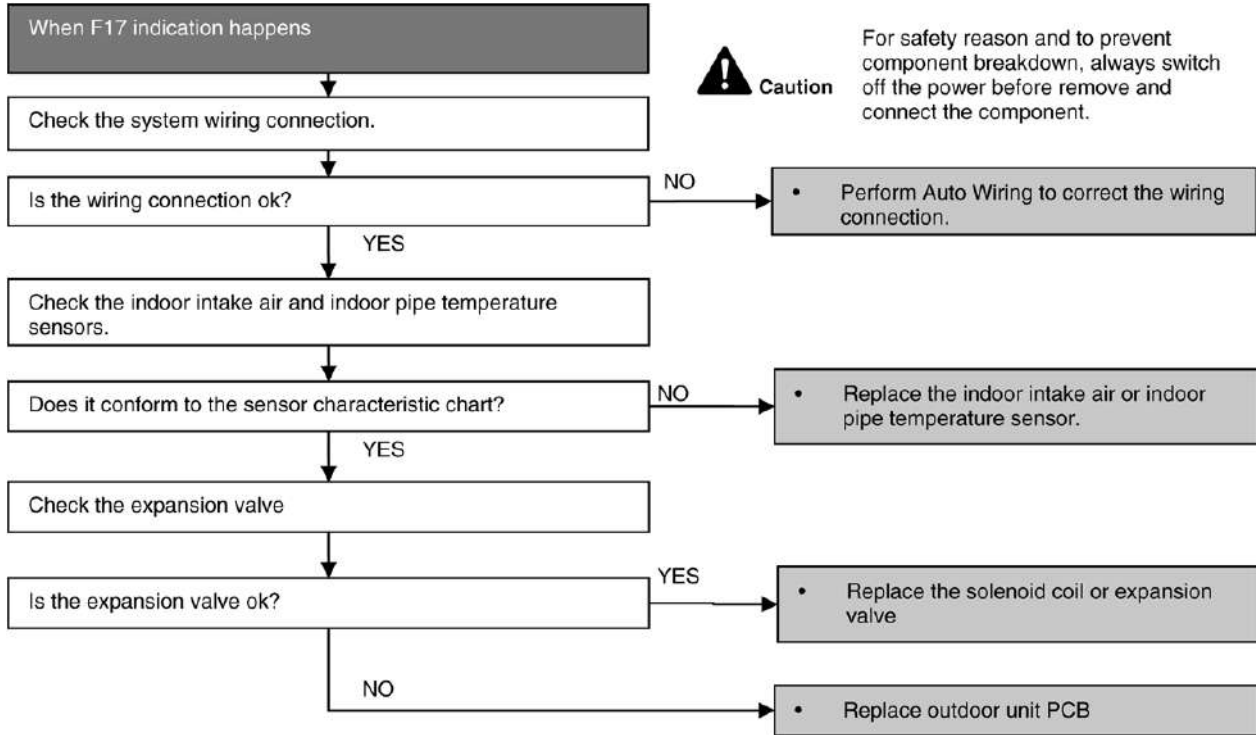

## 18.4.21 F90 (Power Factor Correction Protection)

### Malfunction Decision Conditions

- To maintain DC voltage level supply to power transistor.
- To detect high DC voltage level after rectification.

### Malfunction Caused

- During startup and operation of cooling and heating, when Power Factor Correction (PFC) protection circuitry at the outdoor unit main PCB senses abnormal DC voltage level for power transistors.
- When DC voltage detected is LOW, transistor switching will turn ON by controller to push-up the DC level.
- When DC voltage detected is HIGH (391Vdc – 425Vdc), active LOW signal will send by the controller to turn OFF relay RY-C.

### Troubleshooting

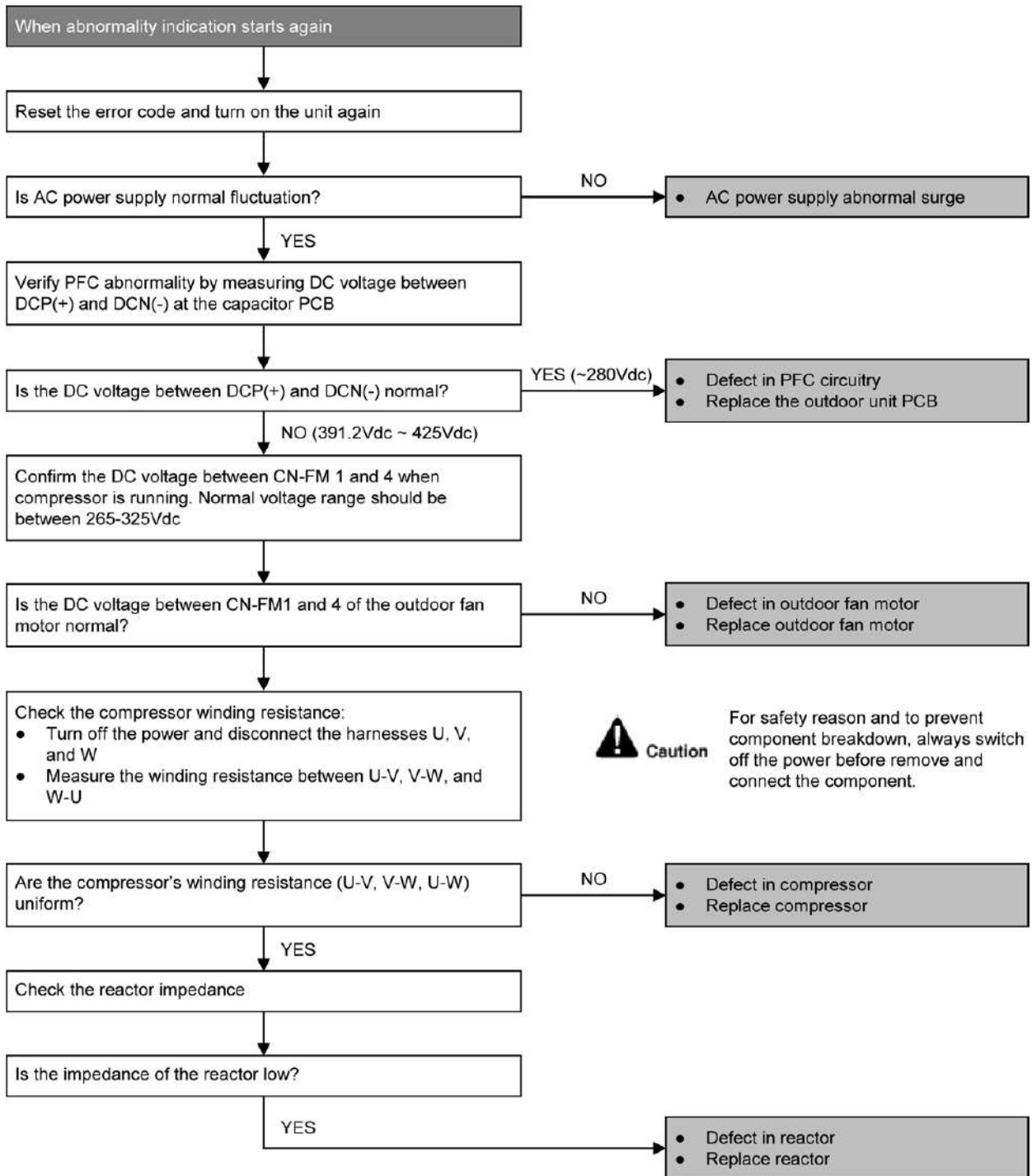

## 18.4.22 F91 (Refrigeration Cycle Abnormality)

### Malfunction Decision Conditions

- The input current is low while the compressor is running at higher than the setting frequency.

### Malfunction Caused

- Lack of gas.
- 3-way valve close.

### Troubleshooting

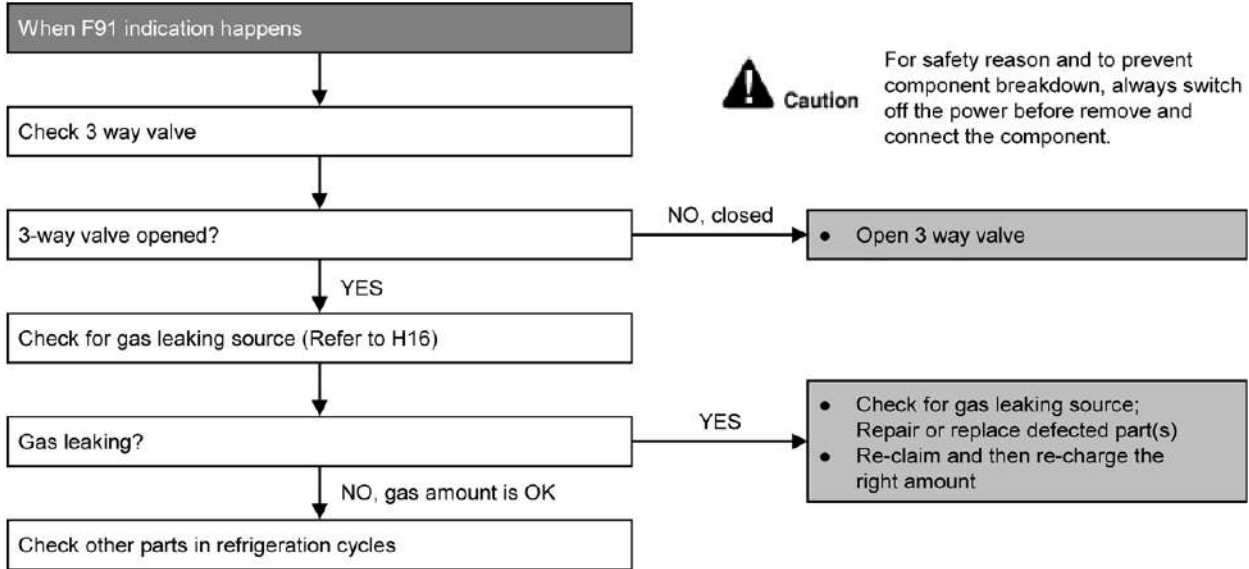

### 18.4.23 F93 (Compressor Rotation Failure)

#### Malfunction Decision Conditions

- A compressor rotation failure is detected by checking the compressor running condition through the position detection circuit.

#### Malfunction Caused

- Compressor terminal disconnect
- Faulty Outdoor PCB
- Faulty compressor

#### Troubleshooting

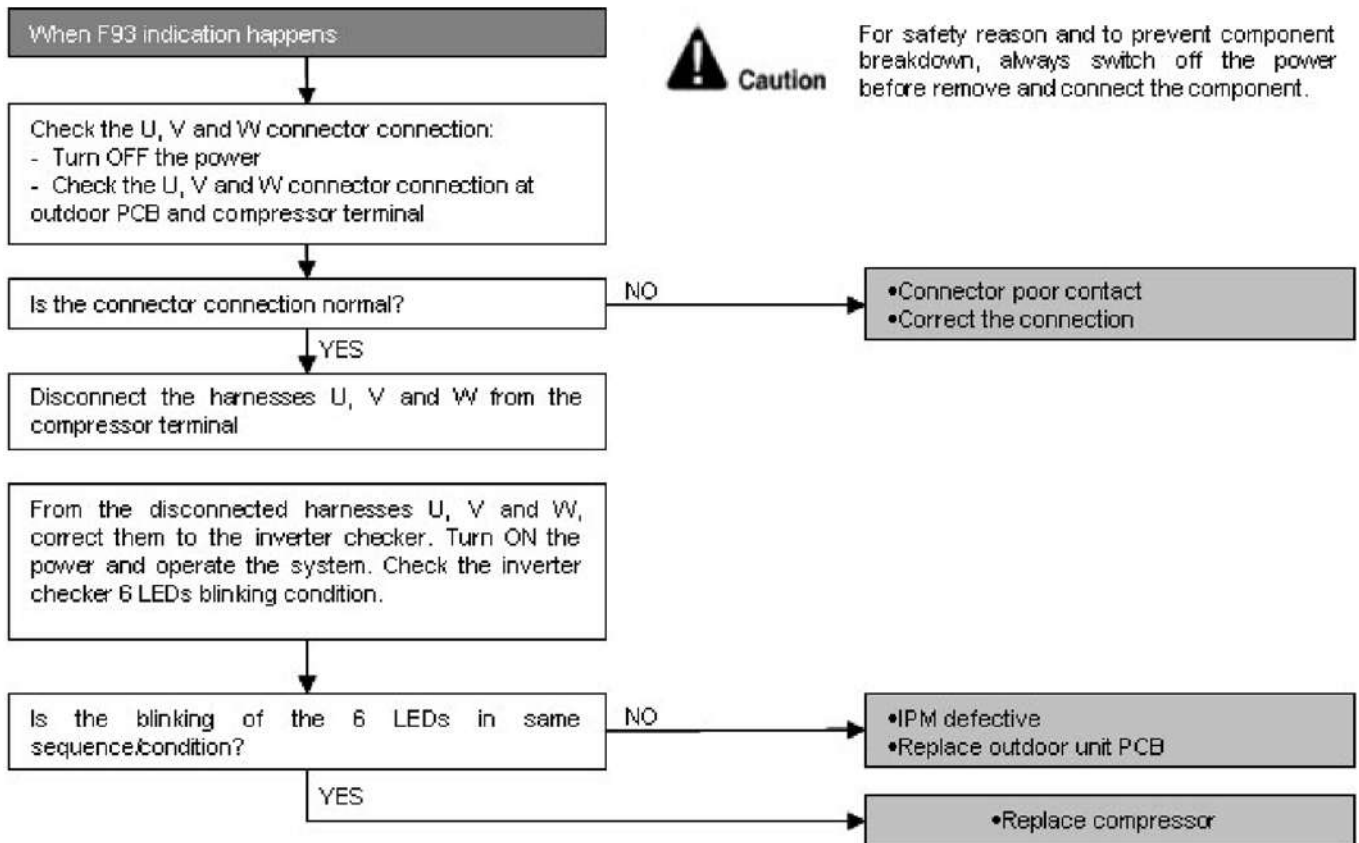

## 18.4.24 F95 (Outdoor High Pressure Protection: Cooling or Soft Dry)

### Malfunction Decision Conditions

- During operation of cooling or soft dry, when outdoor unit heat exchanger high temperature data is detected by the outdoor unit heat exchanger thermistor.

### Malfunction Caused

- Outdoor heat exchanger temperature rise due to short-circuit of hot discharge air flow.
- Outdoor heat exchanger temperature rise due to defective of outdoor fan motor.
- Outdoor heat exchange temperature rise due to defective outdoor heat exchanger thermistor.
- Outdoor heat exchanger temperature rise due to defective of outdoor unit PCB.

### Troubleshooting

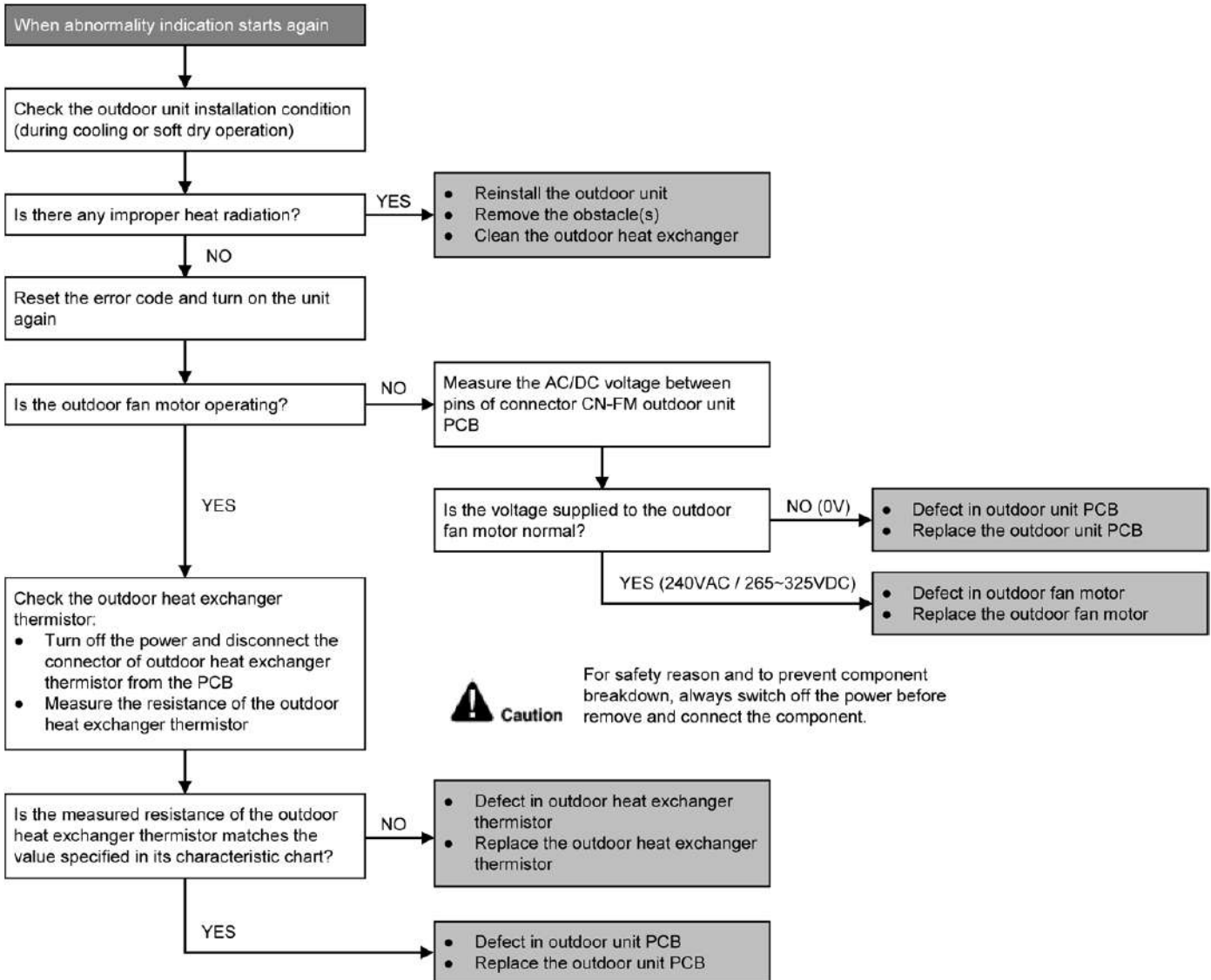

## 18.4.25 F96 (IPM Overheating)

### Malfunction Decision Conditions

- During operating of cooling and heating, when IPM temperature data (100°C) is detected by the IPM temperature sensor.

#### *Multi Models only*

- Compressor Overheating: During operation of cooling and heating, when the compressor OL is activated.
- Heat Sink Overheating: During operation of cooling and heating, when heat sink temperature data (90°C) is detected by the heat sink temperature sensor.

### Malfunction Caused

- IPM overheats due to short circuit of hot discharge air flow.
- IPM overheats due to defective of outdoor fan motor.
- IPM overheats due to defective of internal circuitry of IPM.
- IPM overheats due to defective IPM temperature sensor.

#### *Multi Models Only*

- Compressor OL connector poor contact.
- Compressor OL faulty.

### Troubleshooting

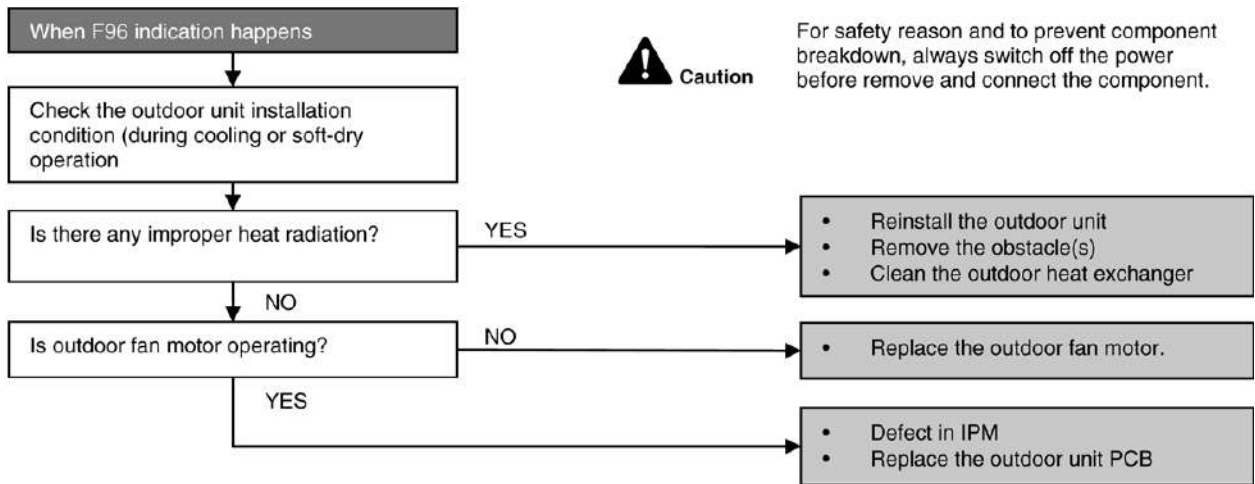

## 18.4.26 F97 (Compressor Overheating)

### Malfunction Decision Conditions

- During operation of cooling and heating, when compressor tank temperature data (112°C) is detected by the compressor tank temperature sensor.

### Malfunction Caused

- Faulty compressor tank temperature sensor
- 2/3 way valve closed
- Refrigerant shortage (refrigerant leakage)
- Faulty outdoor unit PCB
- Faulty compressor

### Troubleshooting

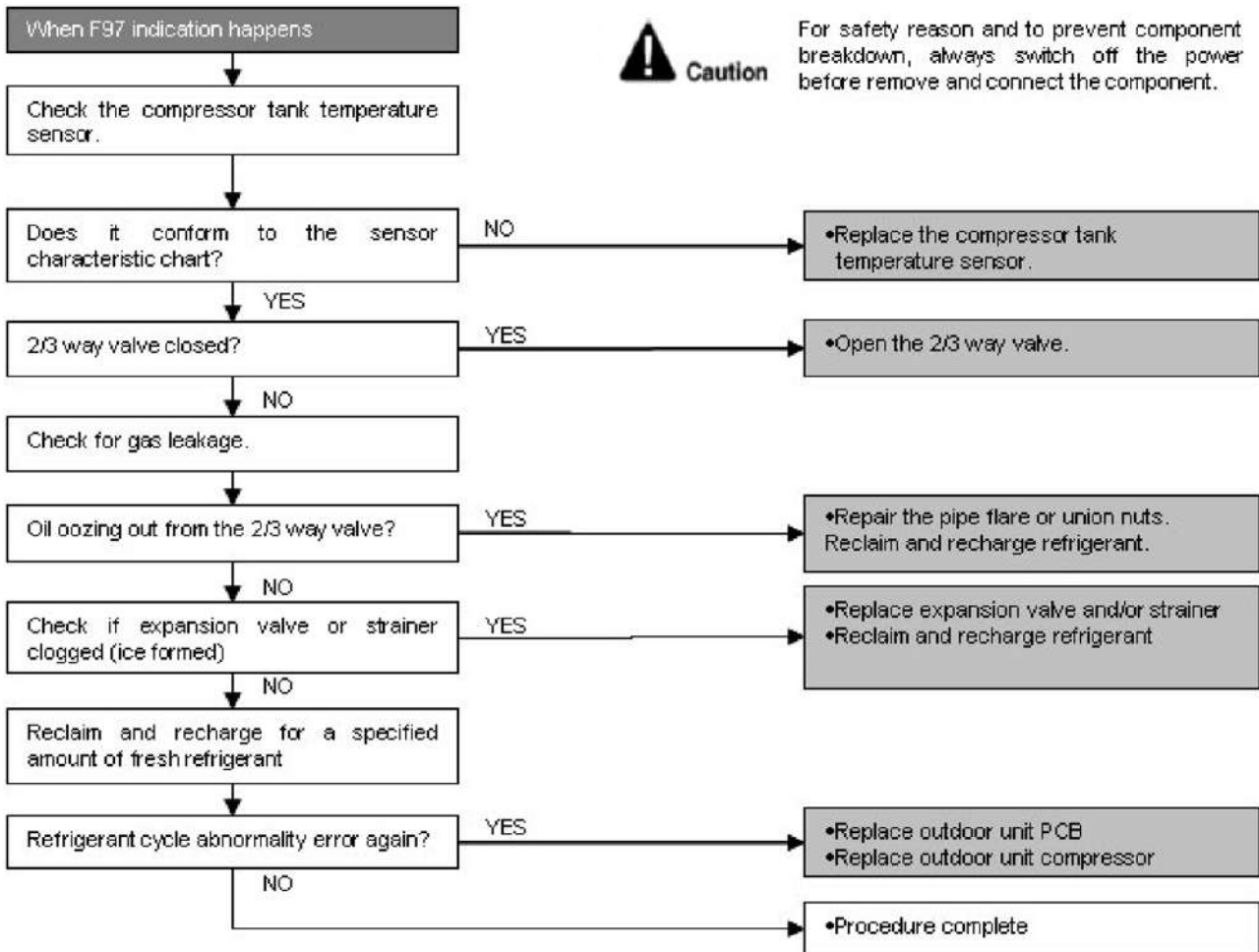

## 18.4.27 F98 (Input Over Current Detection)

### Malfunction Decision Conditions

- During operation of cooling and heating, when an input over-current (X value in Total Running Current Control) is detected by checking the input current value being detected by current transformer (CT) with the compressor running.

### Malfunction Caused

- Excessive refrigerant.
- Faulty outdoor unit PCB.

### Troubleshooting

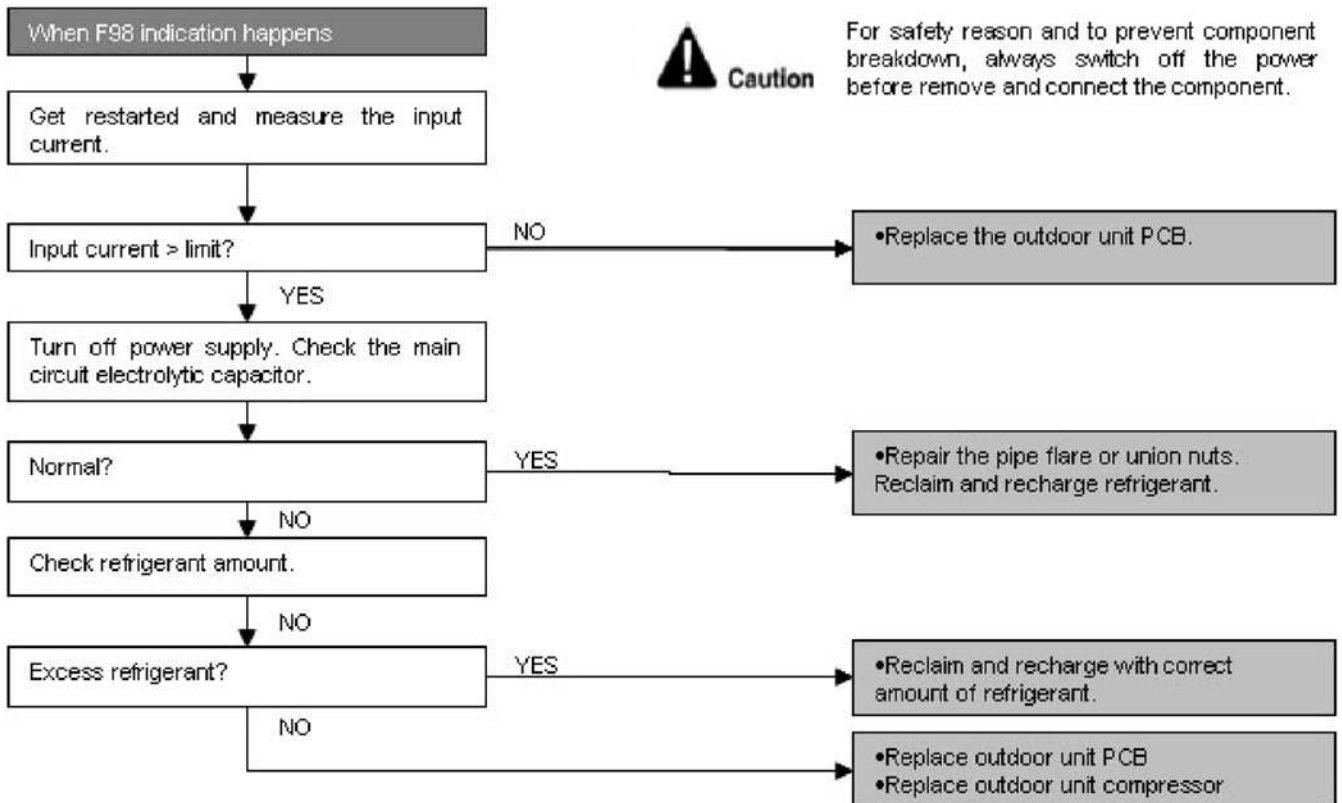

## 18.4.28 F99 (DC Peak Detection)

### Malfunction Decision Conditions

During startup and operation of cooling and heating, when inverter DC peak data is received by the outdoor internal DC Peak sensing circuitry.

### Malfunction Caused

- DC current peak due to compressor failure.
- DC current peak due to defective power transistor(s).
- DC current peak due to defective outdoor unit PCB.
- DC current peak due to short circuit.

### Troubleshooting

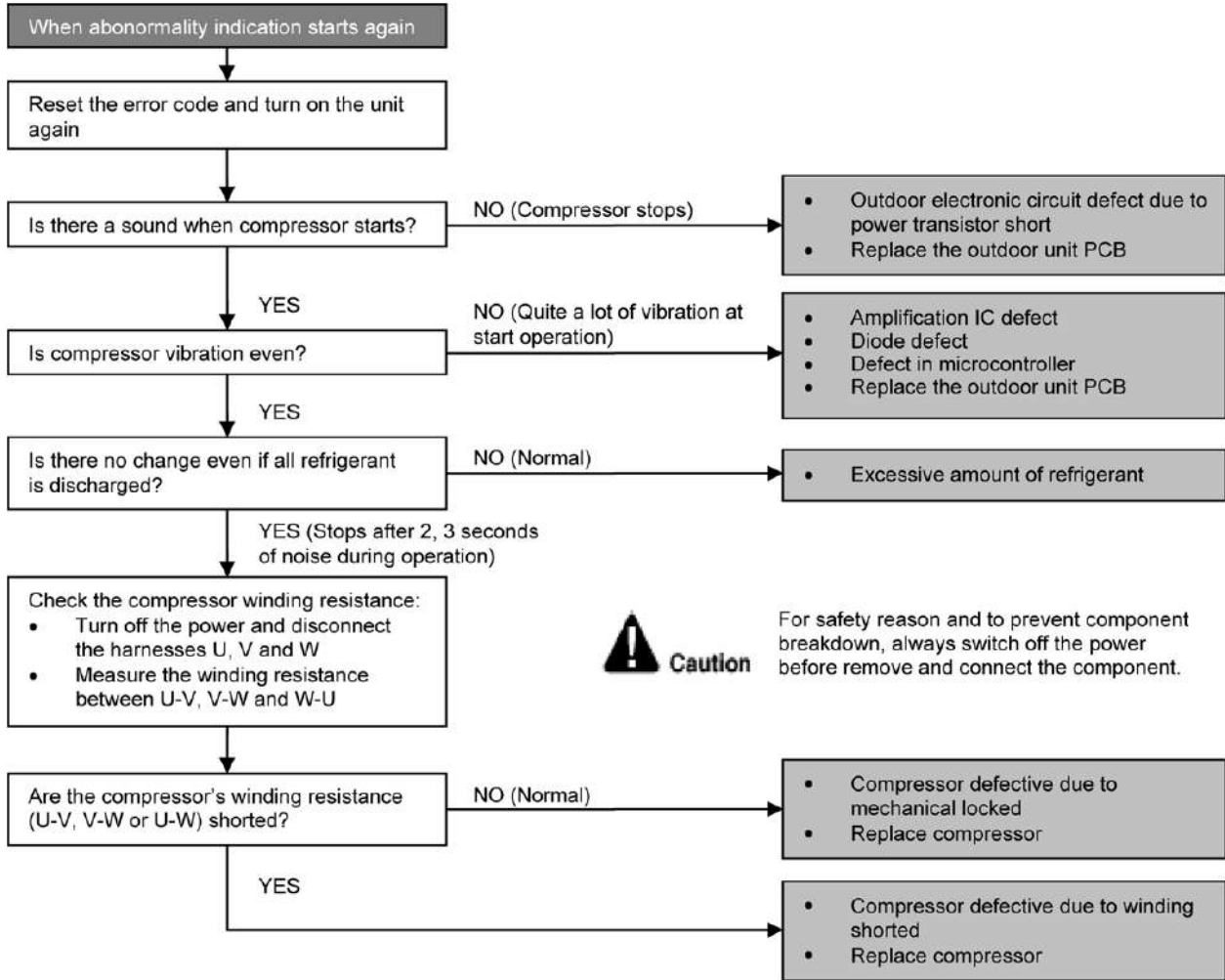

# 19. Disassembly and Assembly Instructions

**⚠ WARNING**

High Voltage is generated in the electrical parts area by the capacitor. Ensure that the capacitor has discharged sufficiently before proceeding with repair work. Failure to heed this caution may result in electric shocks.

## 19.1 CS-TZ20WKEW CS-TZ25WKEW CS-TZ35WKEW CS-TZ42WKEW CS-TZ50WKEW CS-RZ20WKEW CS-RZ25WKEW CS-RZ35WKEW CS-RZ50WKEW

### 19.1.1 Indoor Electronic Controllers, Cross Flow Fan and Indoor Fan Motor Removal Procedures

#### 19.1.1.1 To Remove Front Grille

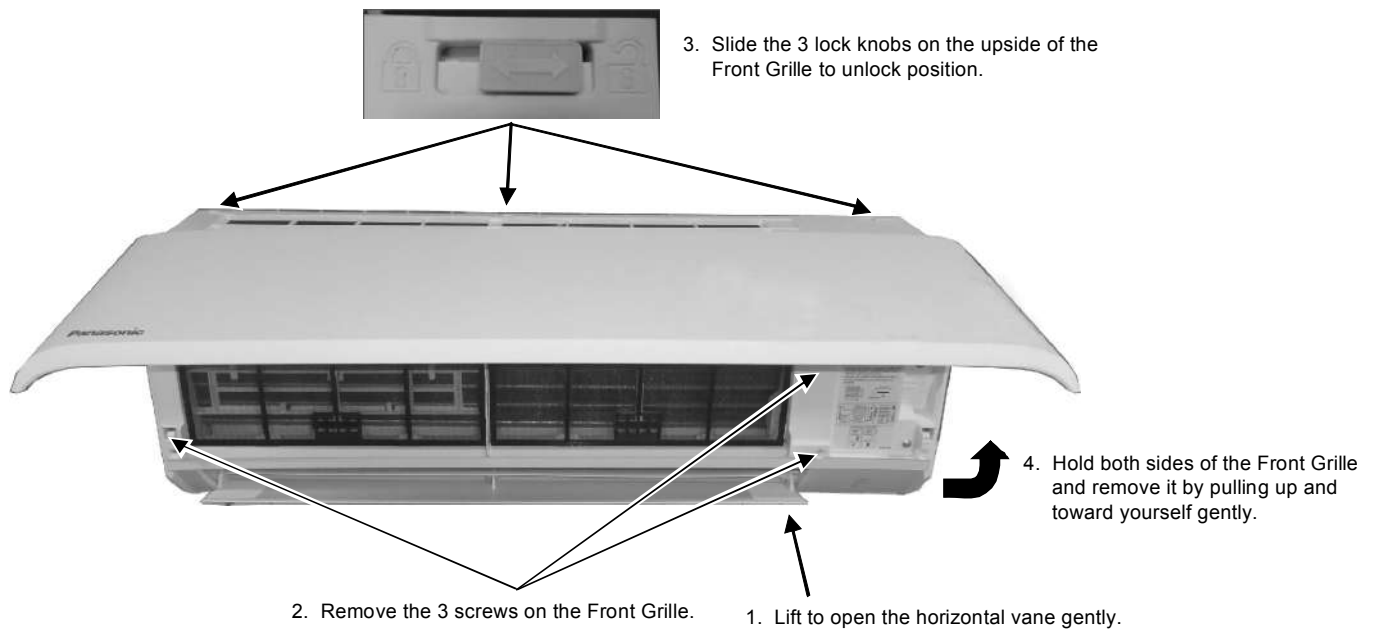

Figure 1

#### 19.1.1.2 To Remove Electronic Controller

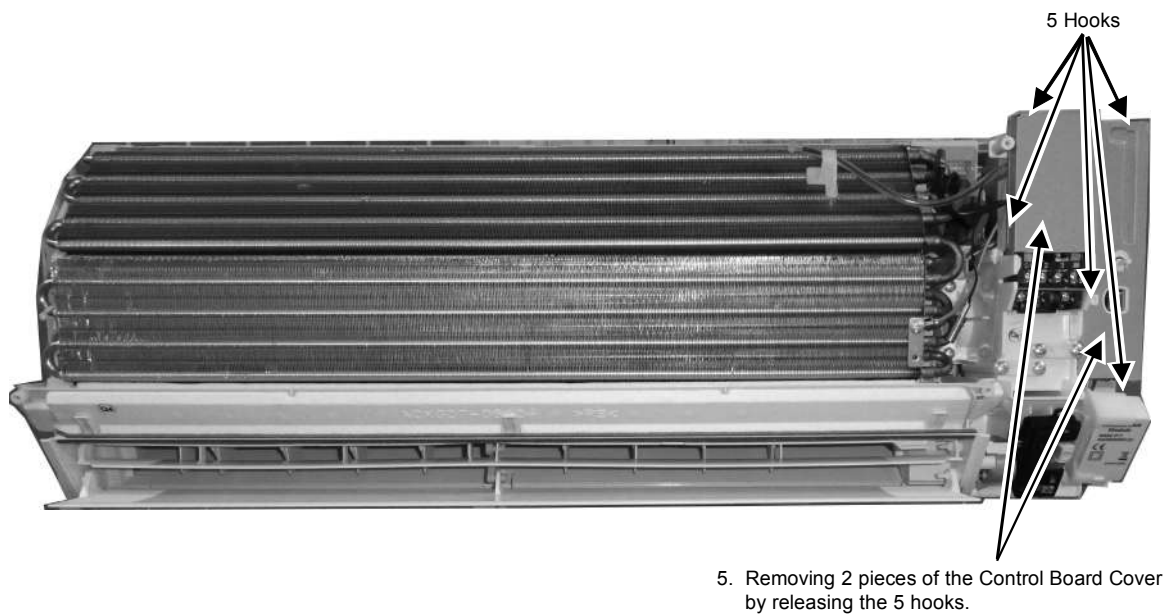
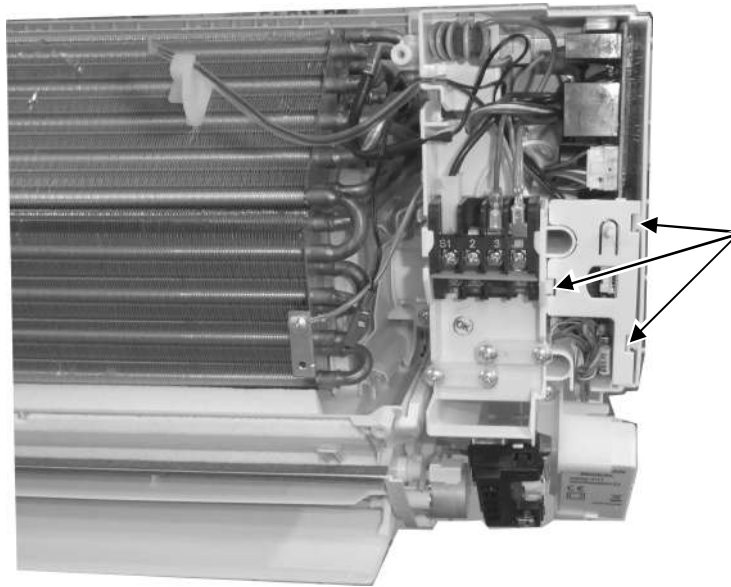

Figure 2



6. Remove the Particular Piece from the 3 hooks.

**Figure 3**

10. Remove the earth wire screw.

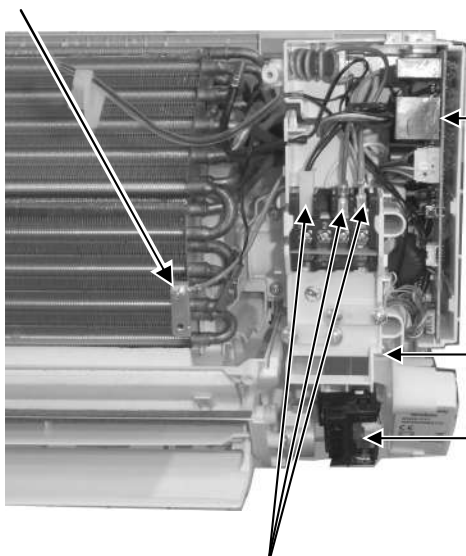

11. Pull out the Main Electronic Controller halfway.

7. Remove the screw of the WIFI Complete.

8. Detach the CN-DISP connector then remove the Indicator Complete.

9. Detach the lead wires AC308 (Black), AC307 (Brown), AC304 (Red) and G301 (Green) from the Terminal Board.

**Figure 4**

12. Detach all connectors as labelled from the Main Electronic Controller. Then pull out the Main Electronic Controller gently.

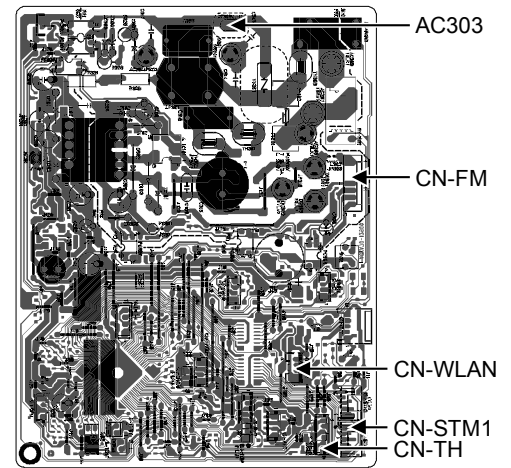

**Figure 5**

### 19.1.1.3 To Remove Discharge Grille

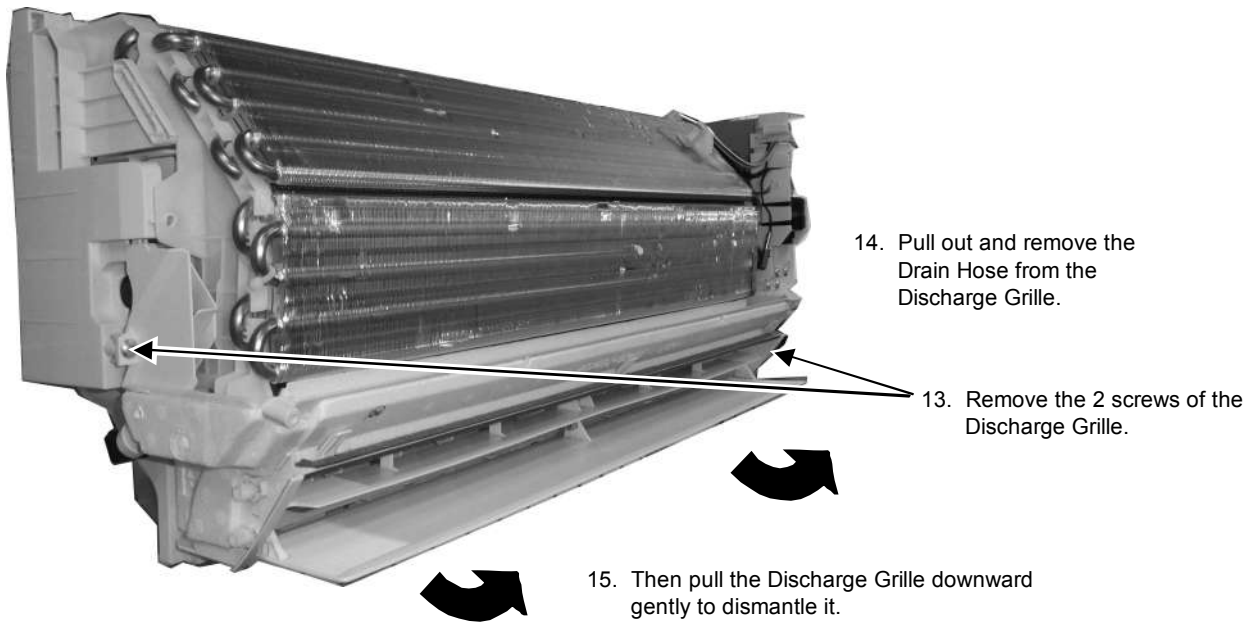

Figure 6

### 19.1.1.4 To Remove Control Board

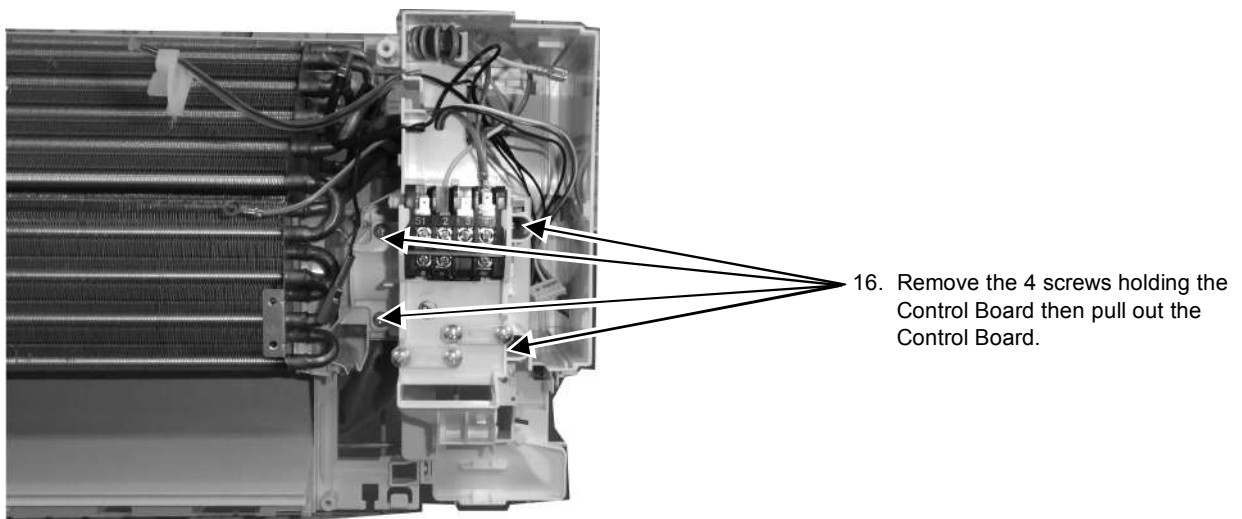
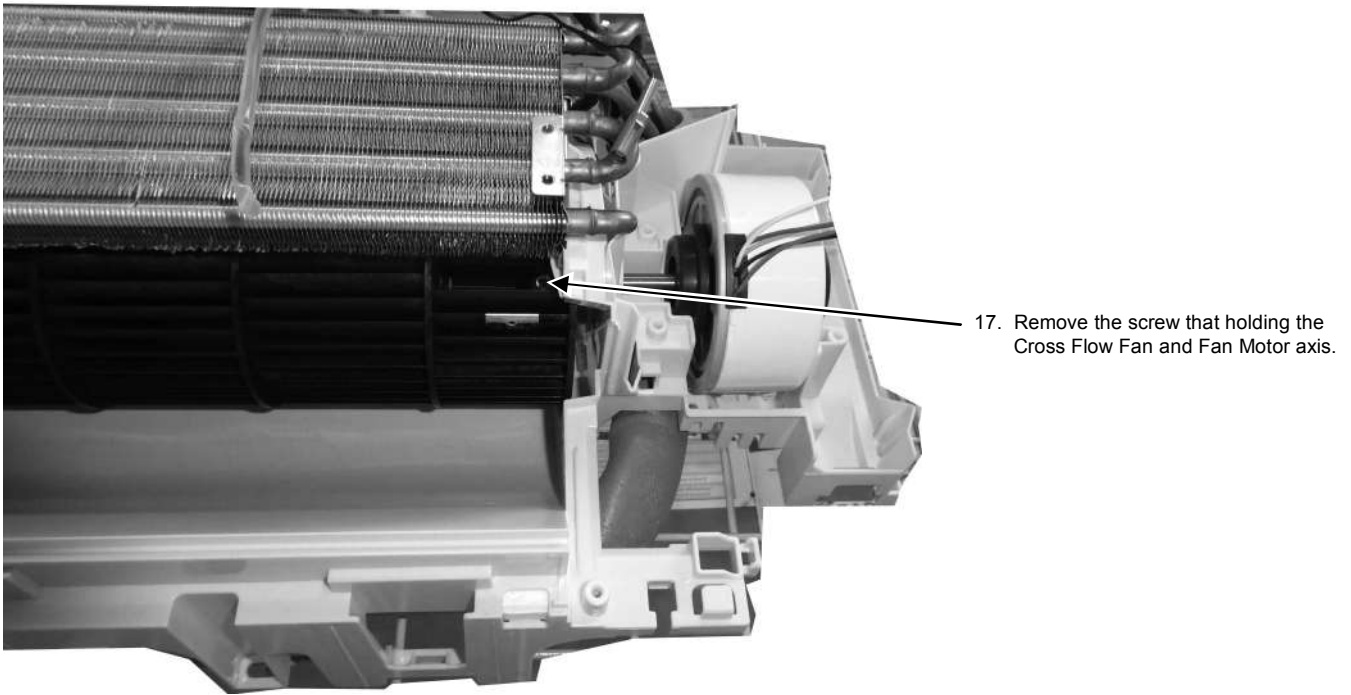
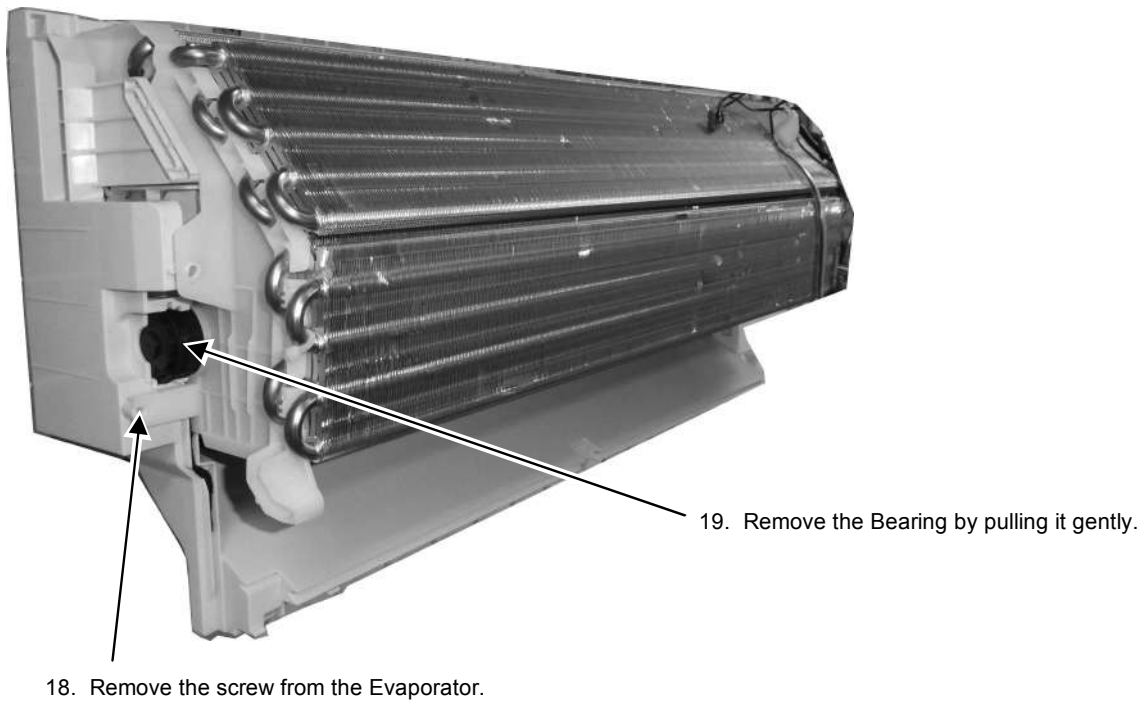

Figure 7

**19.1.1.5 To Remove Cross Flow Fan and Indoor Fan Motor**



**Figure 8**



**Figure 9**

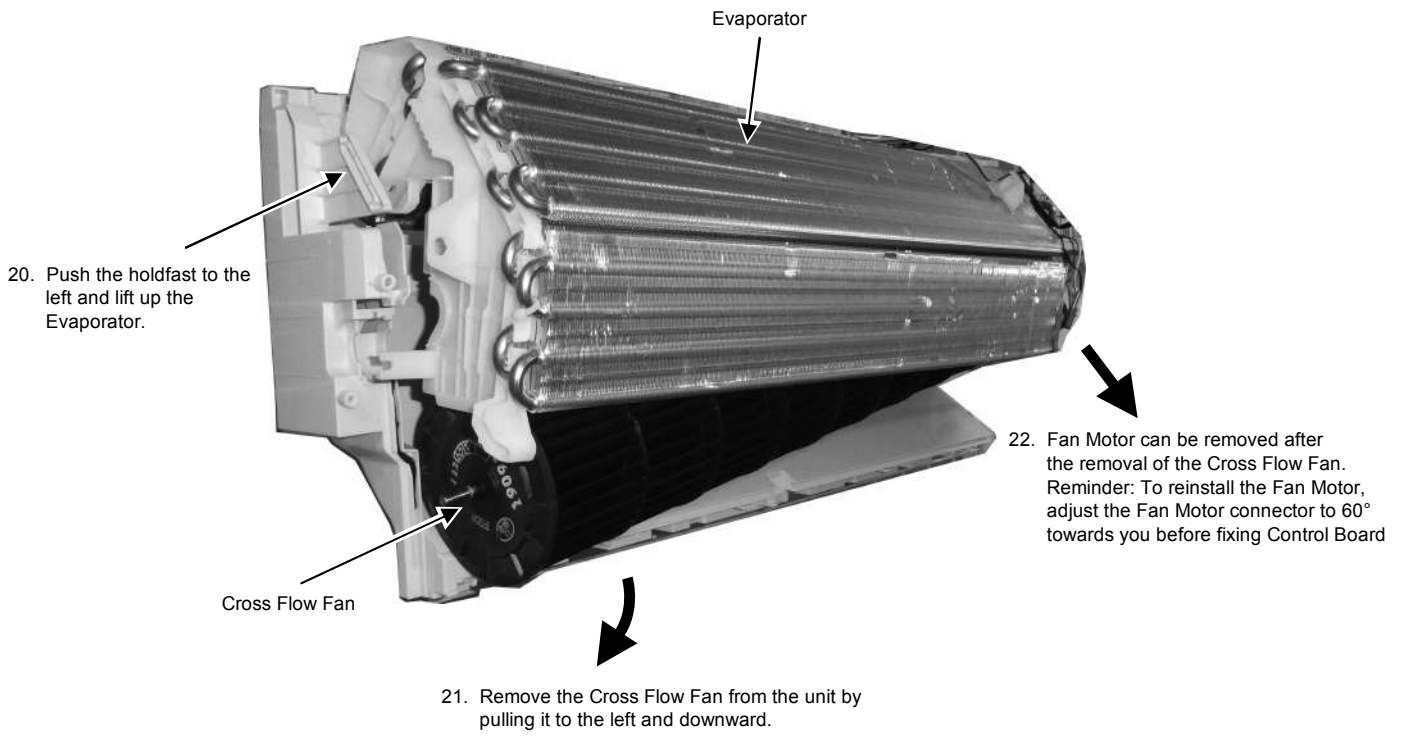

**Figure 10**

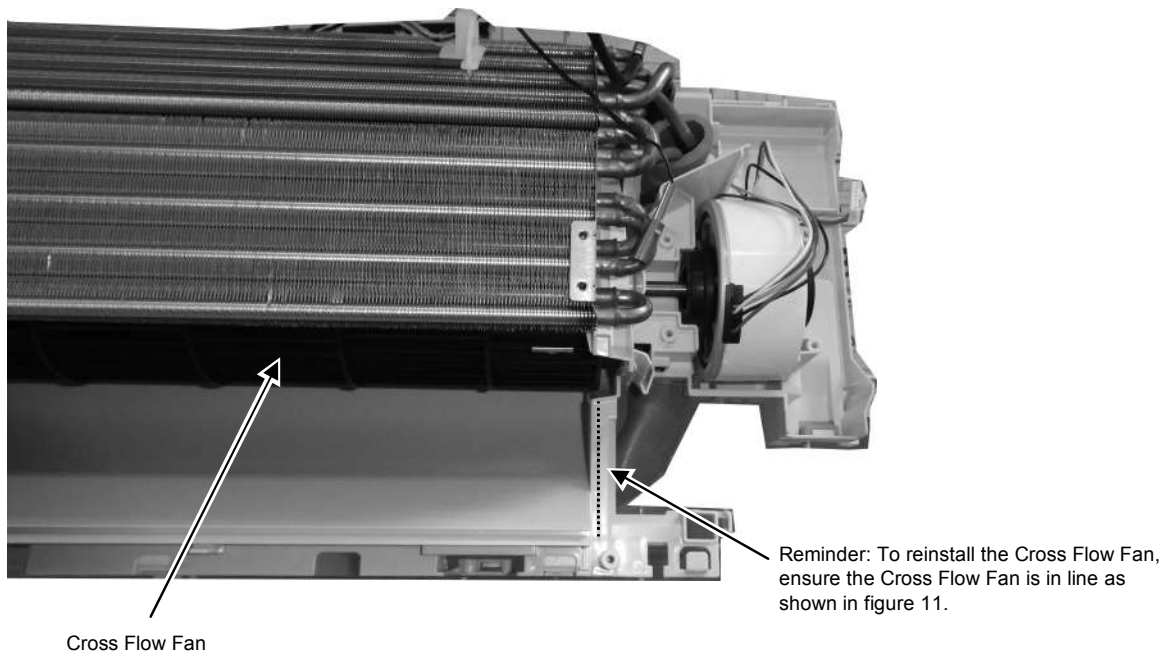

**Figure 11**

⚠ "Precaution of Maintenance"  
Removed all electrical parts before doing wet servicing

 **WARNING**

High Voltage is generated in the electrical parts area by the capacitor. Ensure that the capacitor has discharged sufficiently before proceeding with repair work. Failure to heed this caution may result in electric shocks.

## 19.2 CS-TZ60WKEW CS-TZ71WKEW

### 19.2.1 Indoor Electronic Controllers, Cross Flow Fan and Indoor Fan Motor Removal Procedures

#### 19.2.1.1 To Remove Front Grille

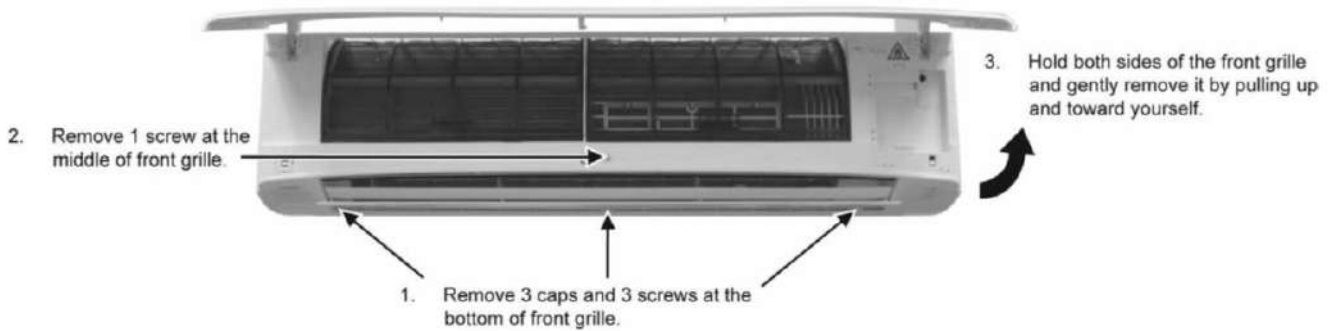

Figure 1

#### 19.2.1.2 To Remove Electronic Controller



Figure 2

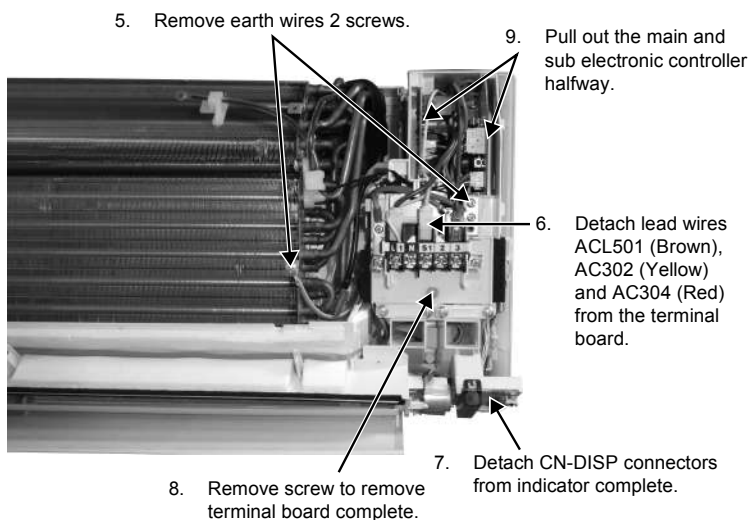

Figure 3

10. Detach all connectors as labelled from the electronic controller. Then pull out the main and sub electronic controller gently.

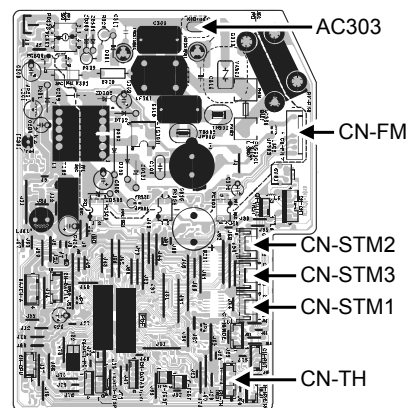

Figure 4

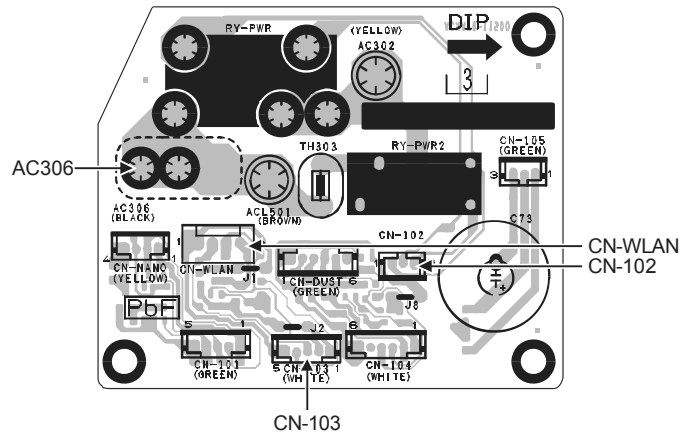

Figure 5

### 19.2.1.3 To Remove Discharge Grille

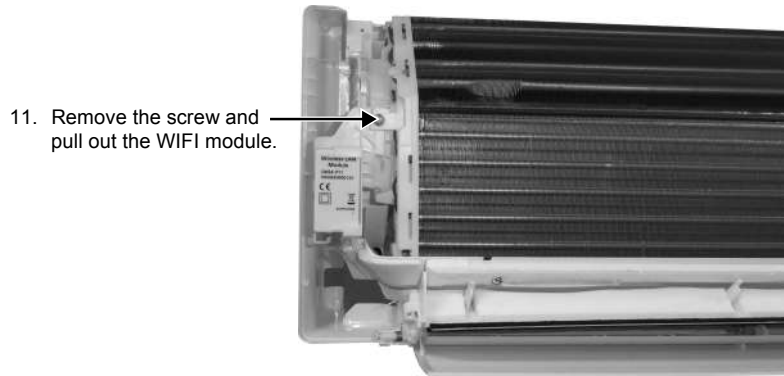

Figure 6

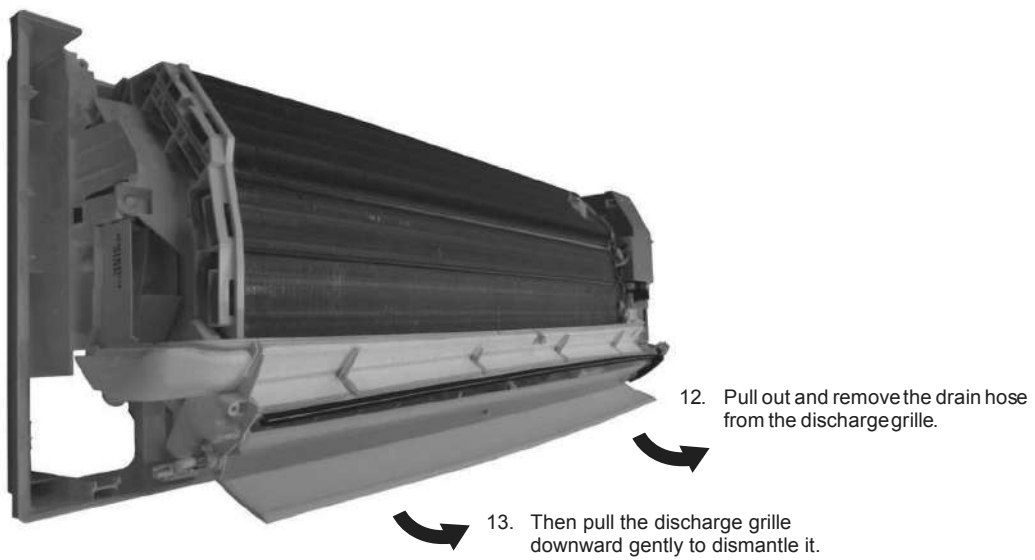

Figure 7

#### 19.2.1.4 To Remove Control Board

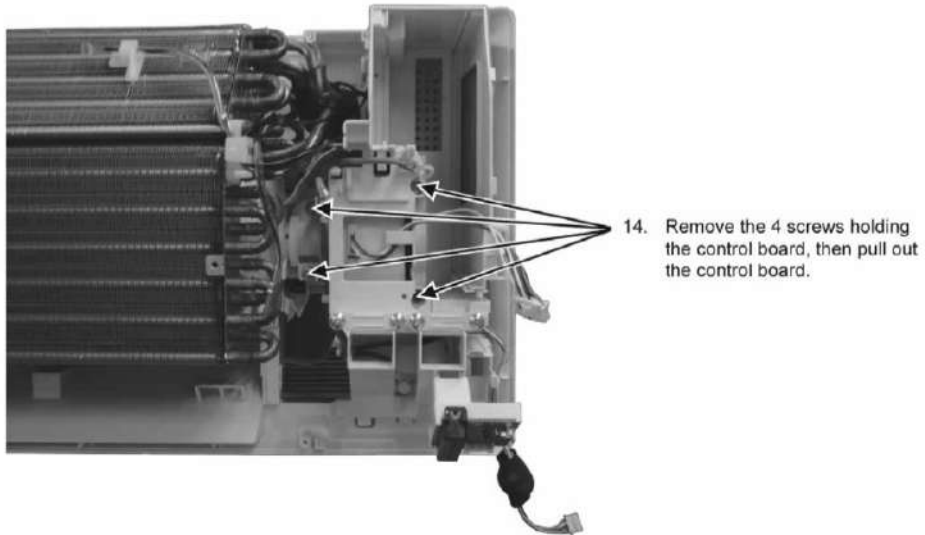

Figure 8

#### 19.2.1.5 To Remove Cross Flow Fan and Indoor Fan Motor

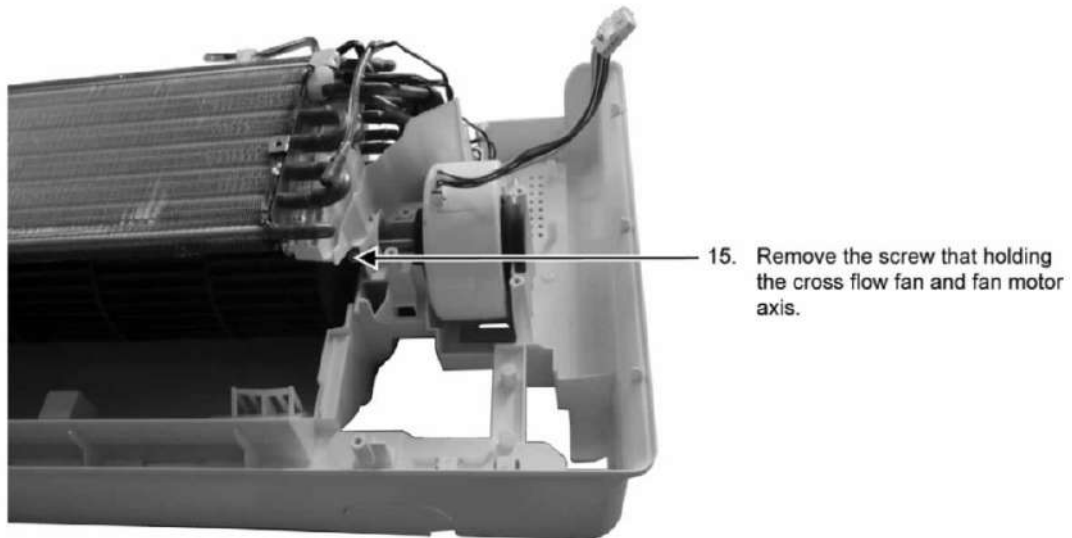

Figure 9

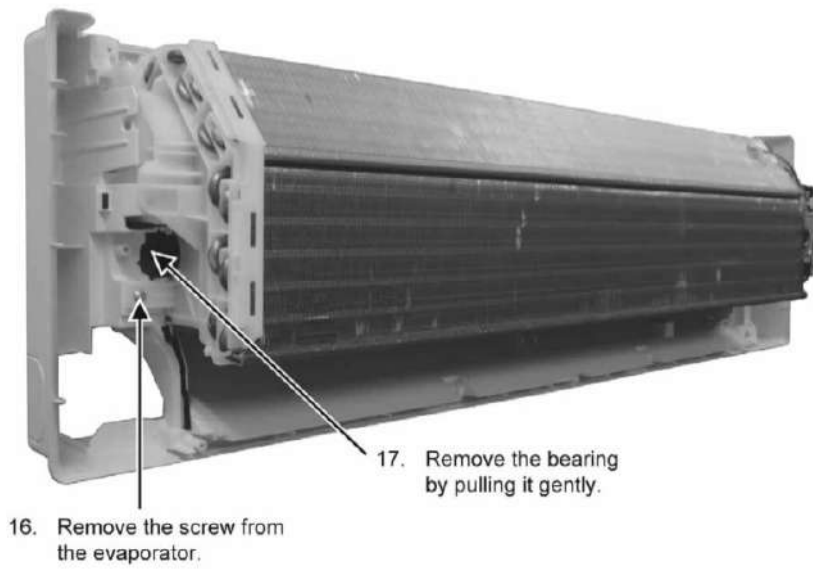

Figure 10

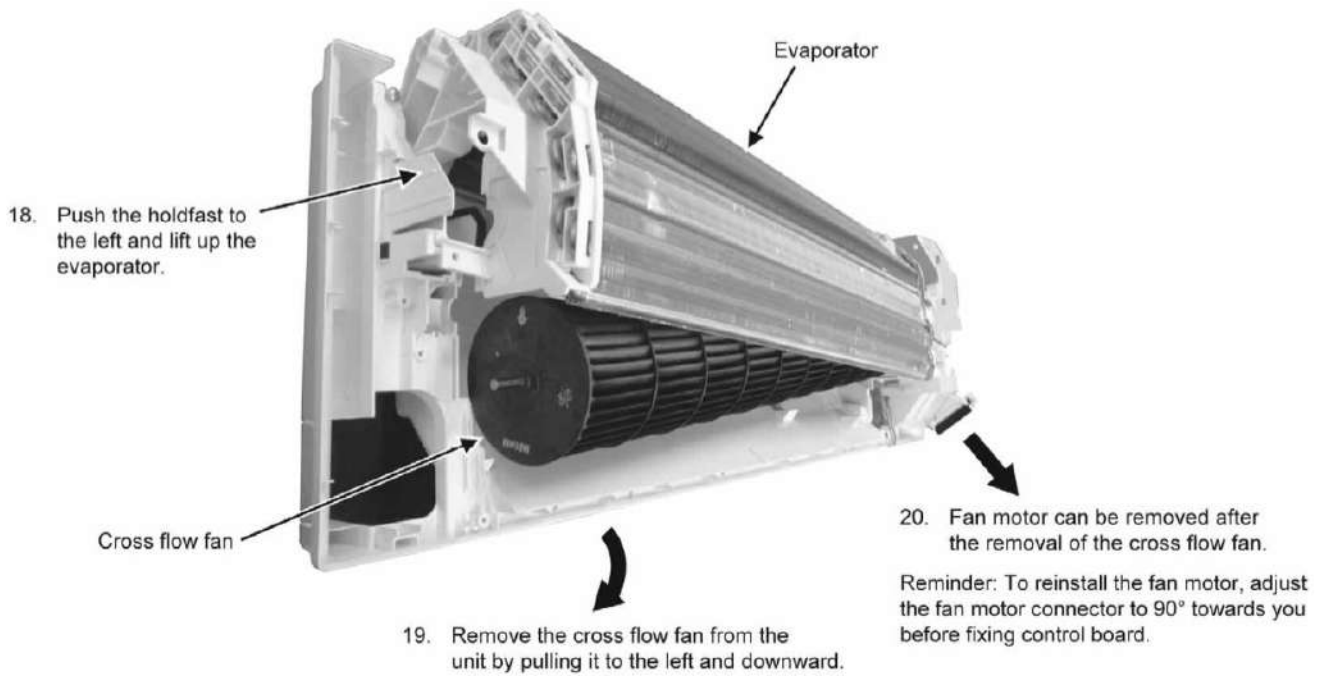

Figure 11

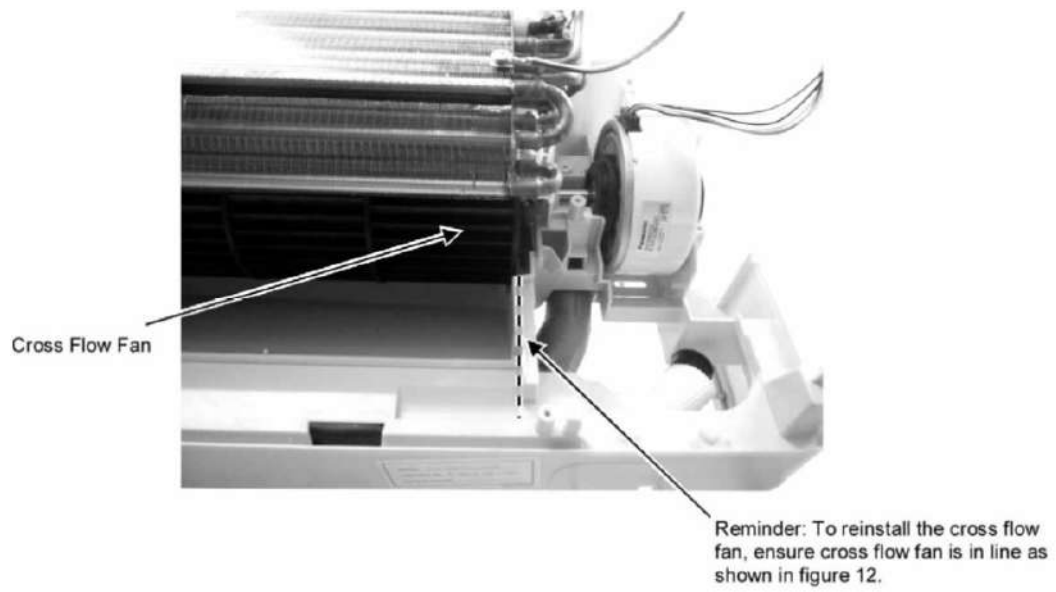
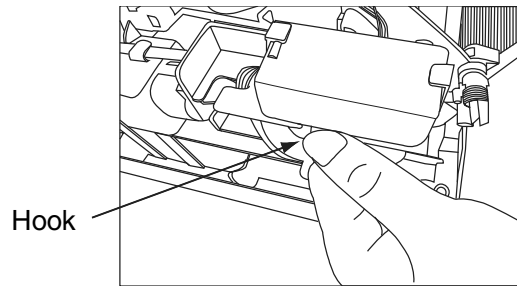

Figure 12

⚠ "Precaution of Maintenance"  
Removed all electrical parts before doing wet servicing

### 19.3 To Replace Wireless LAN Module (Network Adapter)

- 1 Remove the network adapter box by releasing the hook.



- 2 Remove the cover by unclipping it and pulling it out.

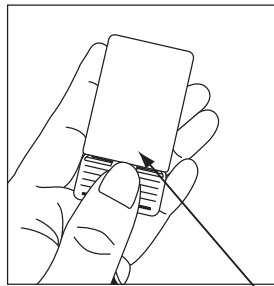

Unclip & pull down

- 3 Remove the top casing by pressing the side of the network adapter box.

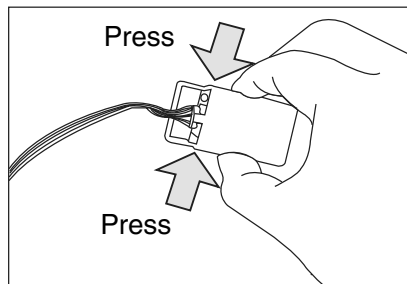

- 4 After that, network adapter can be easily replaced.

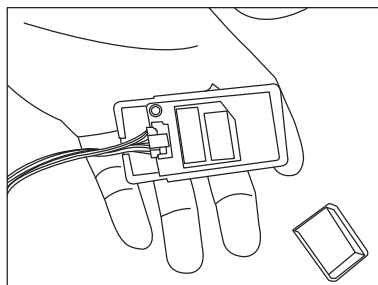

Reminder: Serviceman or owner must setting again Panasonic Comfort Cloud app after replace Wireless LAN Module.

## 19.4 Outdoor Electronic Controller Removal Procedure

### 19.4.1 CU-TZ20WKE CU-TZ25WKE CU-TZ35WKE CU-TZ42WKE CU-RZ20WKE CU-RZ25WKE CU-RZ35WKE

⚠ Caution! When handling electronic controller, be careful of electrostatic discharge.

5 Remove the 5 screws of the Top Panel.

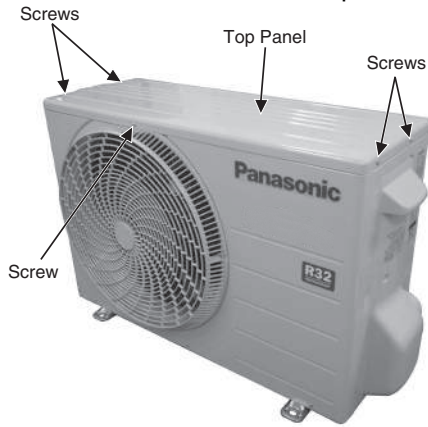

Fig. 1

6 Remove the 6 screws of the Front Panel.

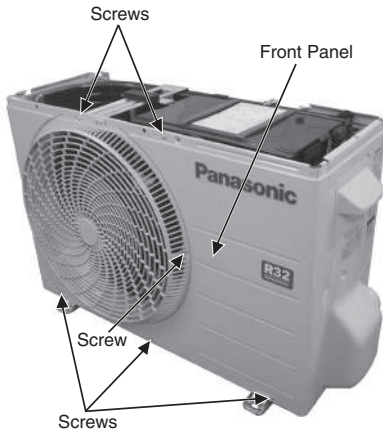

Fig. 2

7 Remove the screw of the Terminal Board Cover.

8 Remove the Top Cover of the Control Board by 4 hooks.

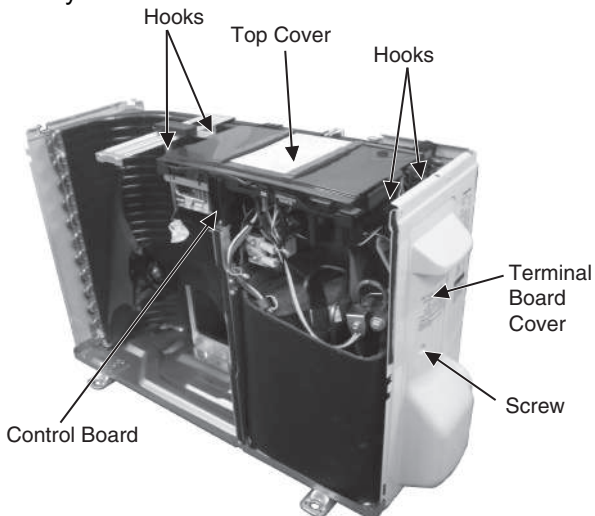

Fig. 3

9 Remove the Control Board as follows:

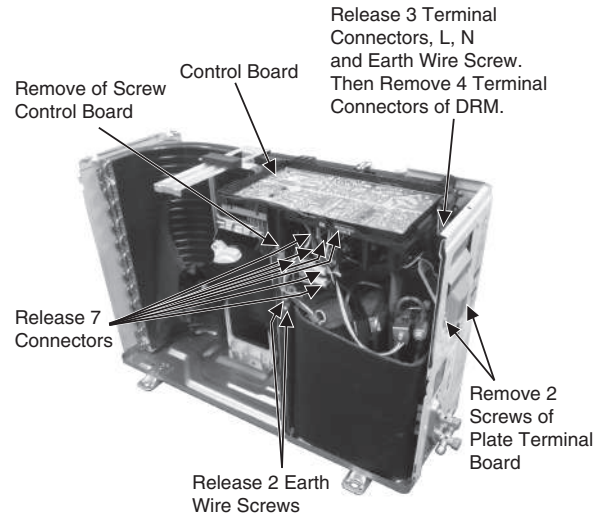

Fig. 4

Remove the Terminal Cover and 3 Terminal Compressor

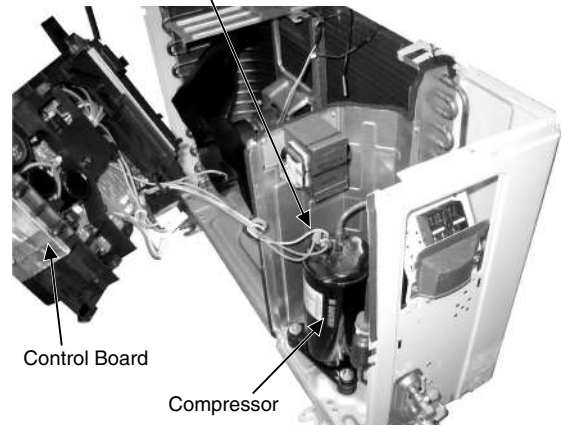

Fig. 5

Electronic Controller Control Board

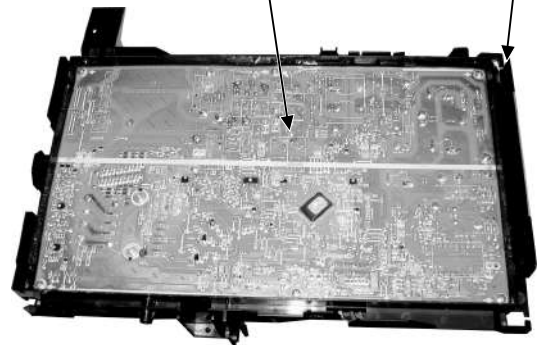

Fig. 6

## 19.4.2 CU-TZ50WKE CU-TZ60WKE CU-RZ50WKE

⚠ Caution! When handling electronic controller, be careful of electrostatic discharge.

- 1 Remove the 5 screws of the Top Panel.

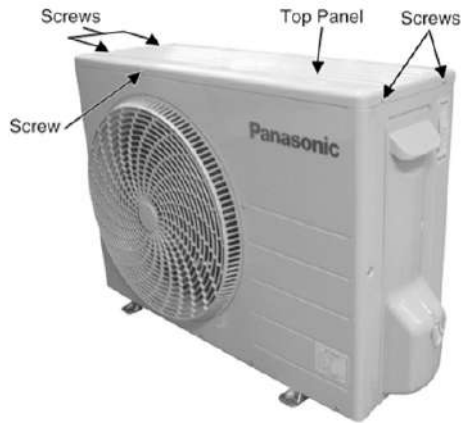

Fig. 1

- 2 Remove the 8 screws of the Front Panel.

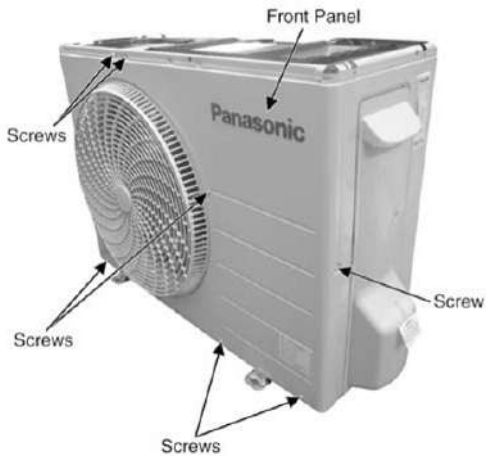

Fig. 2

- 3 Remove the screw of the Terminal Board Cover.
- 4 Remove the Top Cover of the Control Board by 4 hooks.

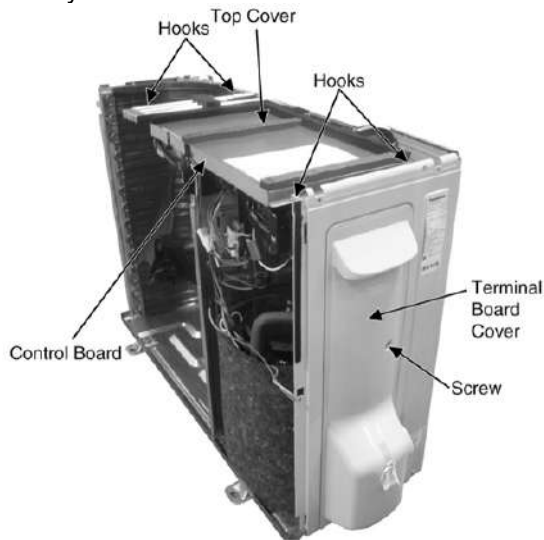

Fig. 3

- 5 Remove the Control Board as follows:

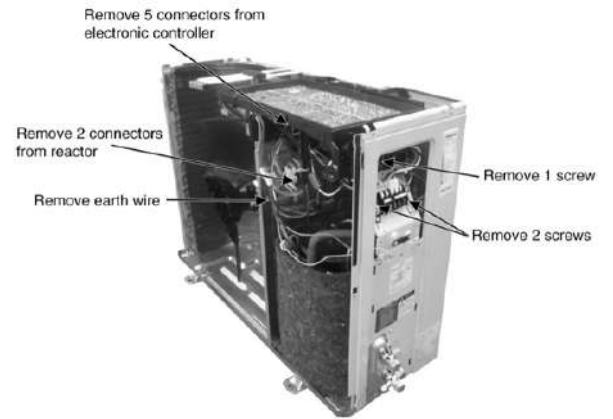

Fig. 4

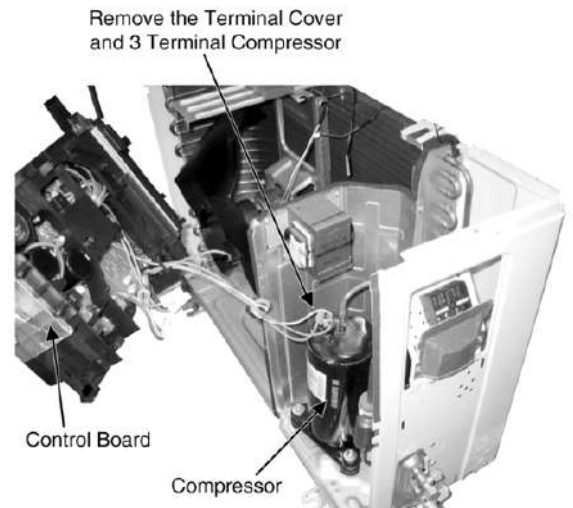

Fig. 5

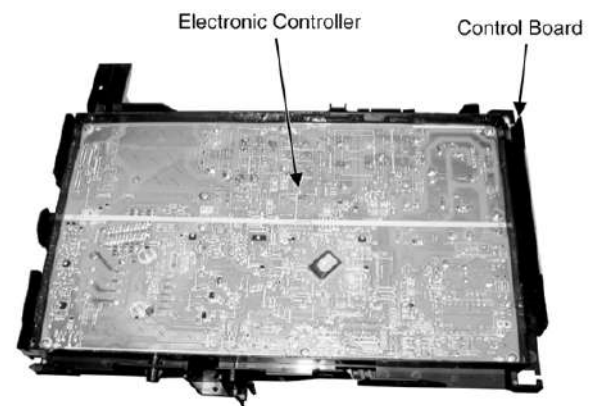

Fig. 6

### 19.4.3 CU-TZ71WKE

⚠ Caution! When handling electronic controller, be careful of electrostatic discharge.

- 1 Remove the 5 screws of the Top Panel.

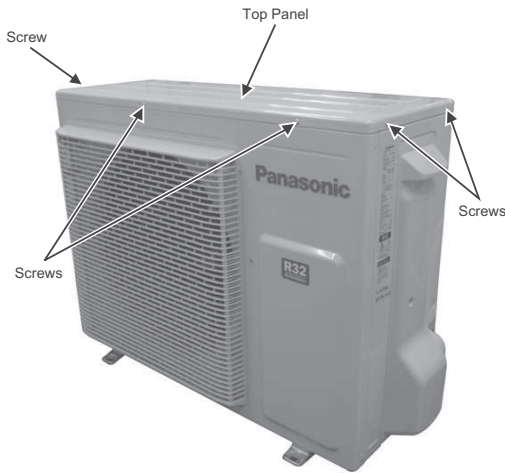

Fig. 1

- 2 Remove the 8 screws of the Front Panel.

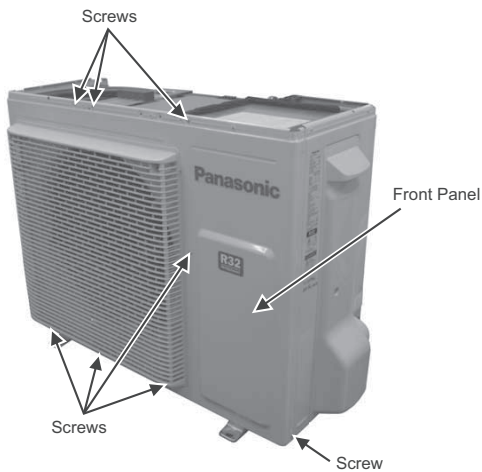

Fig. 2

- 3 Remove the screw of the Terminal Board Cover.

- 4 Remove the Top Cover of the Electronic Controller by 4 hooks.

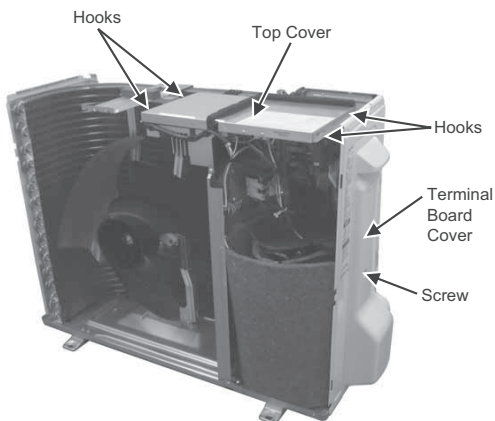

Fig. 3

- 5 Remove 2 screws for the plate of Terminal Board Cover.

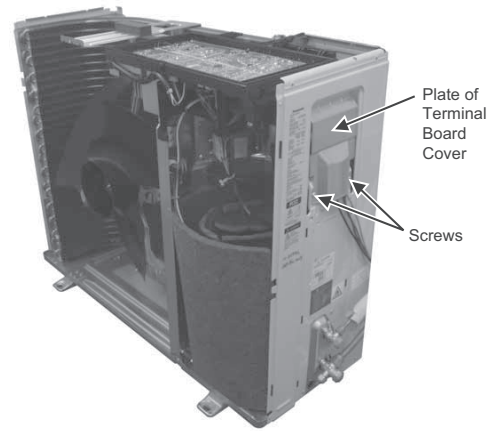

Fig. 4

- 6 Remove the Control Board.

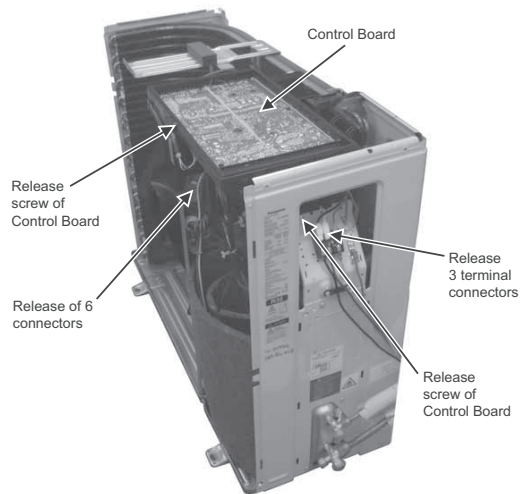
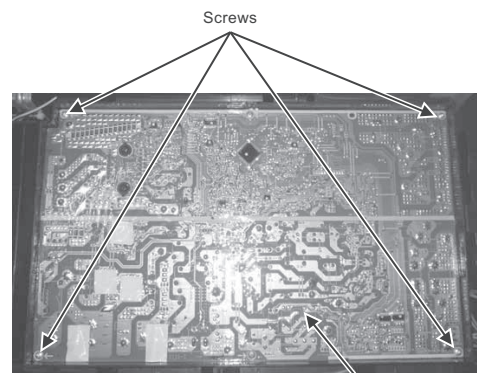

Fig. 5

- 7 Remove the 4 screws of the Electronic Controller.



Electronic Controller

Fig. 6

## 19.5 To Set Panasonic Comfort Cloud App. After Replace Main Printed Circuit Board and Wireless LAN Module

### 19.5.1 'Panasonic Comfort Cloud' App Setting Procedure [ After Replace Main Printed Circuit Board]

#### 19.5.1.1 Initial Setup

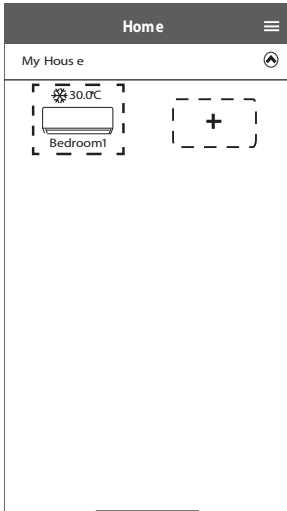

1. Select air-conditioner.

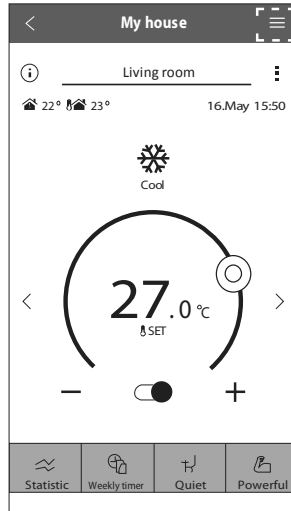

2. Select 'Menu'.

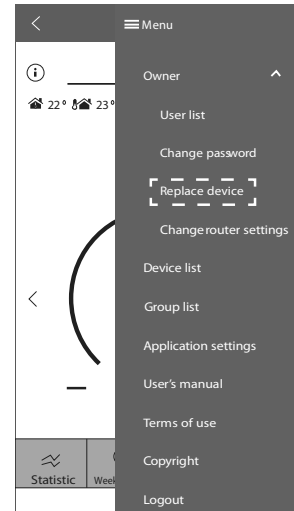

3. Select 'Replace device'.

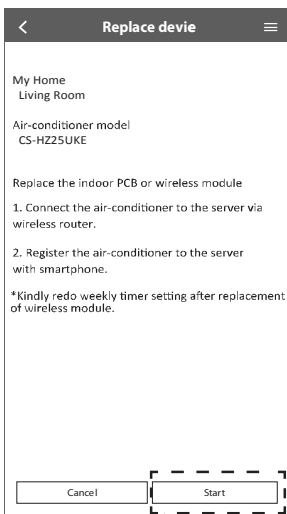

4. Select start button to proceed for network setting.

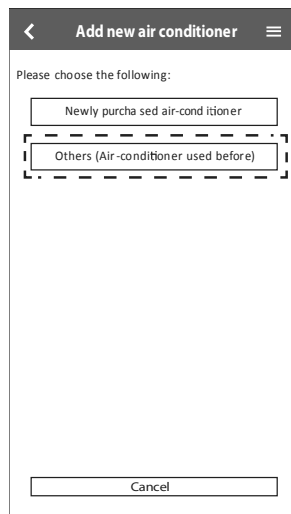

5. Select 'Others (Air-Conditioner used before)'

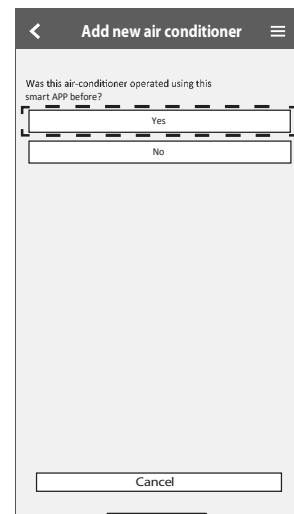

6. Select 'Yes'.

## 19.5.1.2 Setting Connection Network

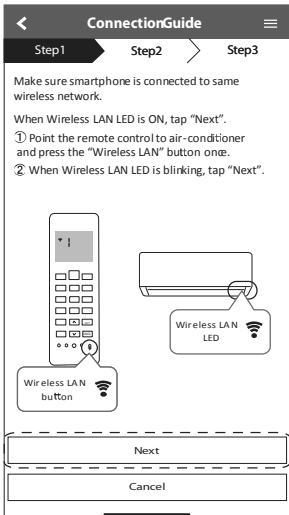

1. Ensure Wireless LAN LED is ON. point the remote control to air conditioner and press Wireless LAN button until the Wireless LAN LED changed to blinking.

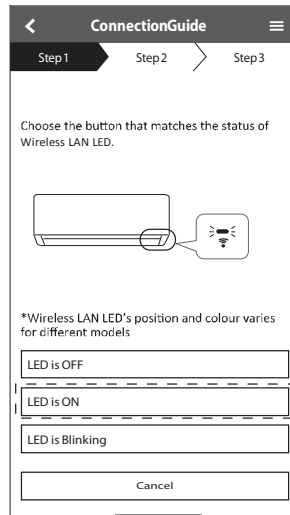

2. When Wireless LAN LED is blinking, select preferred connection setup mode.

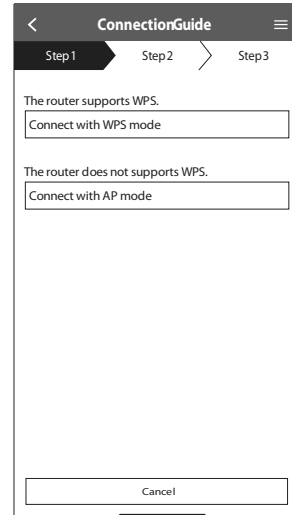

3. Select the preferred router support connectivity mode.

## 19.5.1.3 Connection Network Using WPS Mode (Method 1)

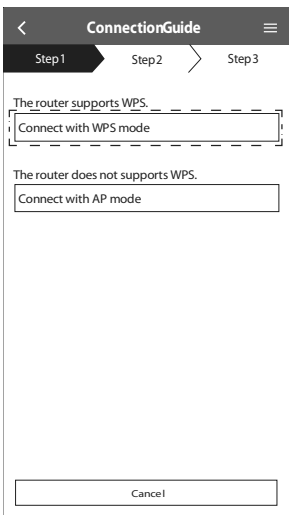

1. Select 'Connect with WPS mode'.

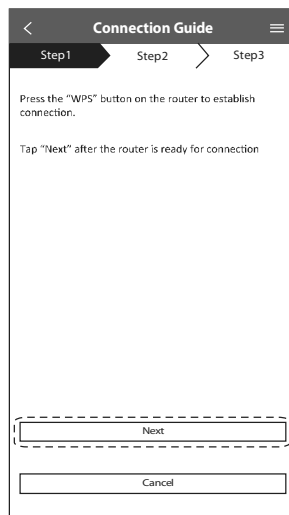

2. Press the "WPS" button from the router that will be connected to an air conditioner.
  - Check the status of Wireless LAN LED on the remote control. If the Wireless LAN LED is OFF, press the Wireless LAN button to enable the Wireless LAN connection.

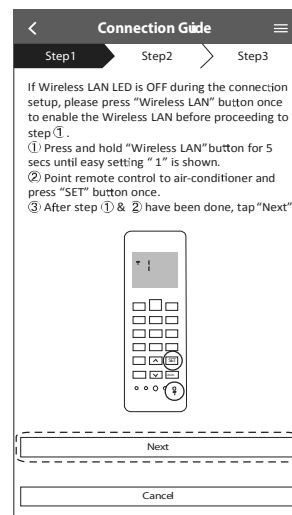

3. Ensure Wireless LAN LED is ON. Press and hold the Wireless LAN button for 5 seconds until "1" is shown on the remote control and press pointing to the air conditioner.

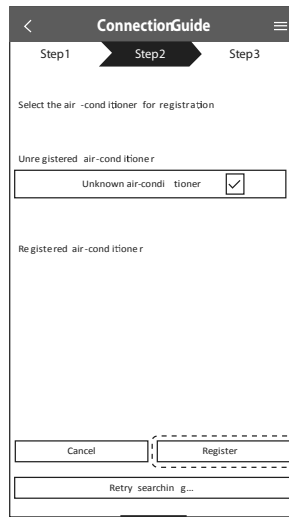

4. If the Wireless LAN LED keep blinking, check the wireless router connection.

5. Select the air conditioner model to register the device.

### 19.5.1.4 Connection Network Using AP Mode (Method 2)

\* (For Android 4.4 and above & iOS 11 and above only)

- ① Ensure Wireless LAN LED is ON. Press and hold the Wireless LAN button for 5 seconds until "4" is shown on the remote control. Press until "2" is shown on the remote control and press pointing to the air conditioner. Join to connect "Panasonic-CS-wirelessAP" network.

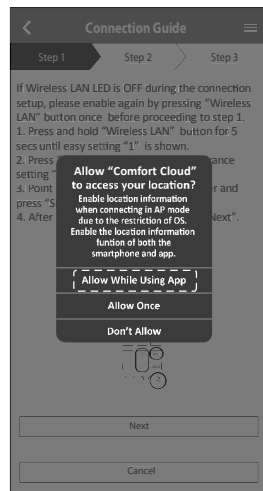
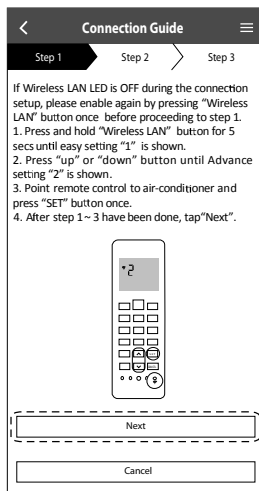

- ② Enter the password of the selected wireless router and continue.

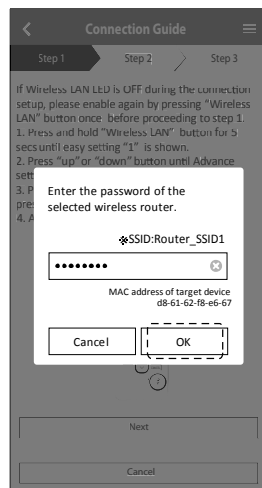

- ③ When connection of air conditioner to router is successful, the Wireless LAN LED will be changed from blinking to ON. If the Wireless LAN LED is ON, connect the smartphone to wireless router. (return to this application after completing the wireless network settings to continue the setup)
- If the Wireless LAN LED keep blinking, check the wireless router connection.

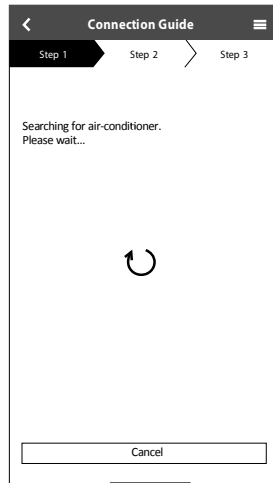
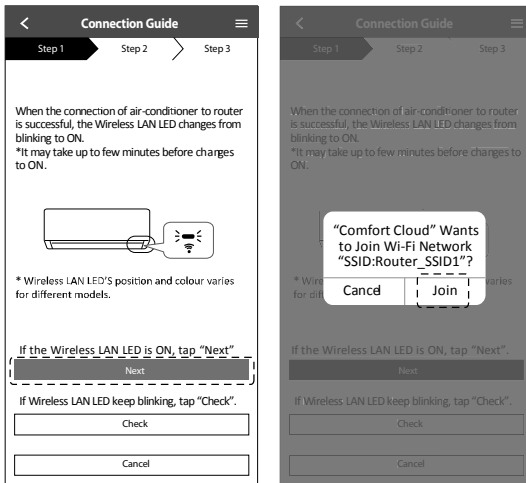

### 19.5.1.5 Select the Air-Conditioner and Set the Password

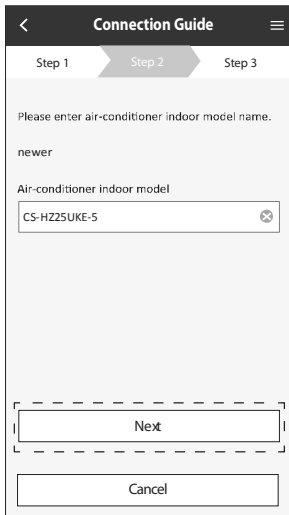

1. Select the air-conditioner model to register the device.

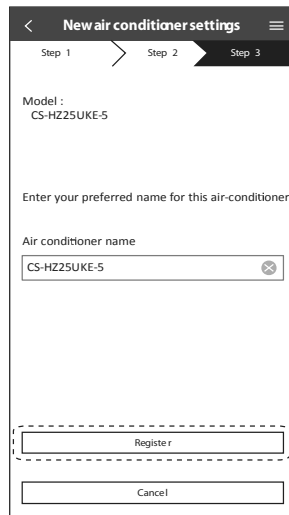

2. Once connection is established between the app and the new air-conditioner through the registration process, set the preferred name for this air-conditioner to help identify it.

- By registered the new name of air conditioner, the function of "Panasonic Comfort Cloud" app is ready to be used.

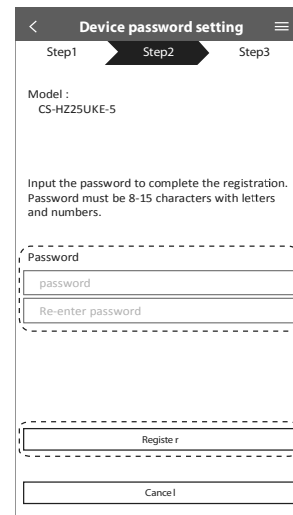

3. Password must be 8-15 characters with letters and number.

**Note**  
Keep password for future used on additional user registration.

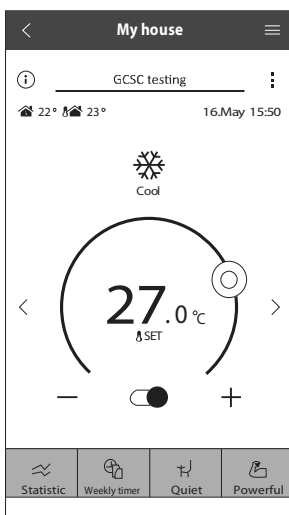

4. Setting completed.

By registered the new name of air

## 19.5.2 'Panasonic Comfort Cloud' App Setting Procedure [After Replace Wireless LAN Module]

### 19.5.2.1 Initial Setup (Method 1)

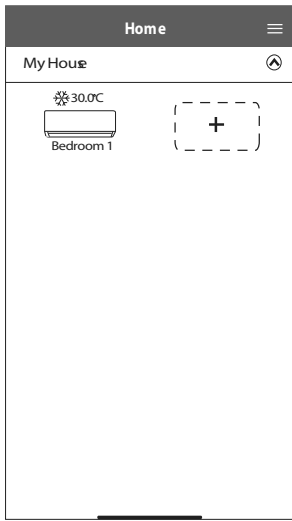

1. Select model.

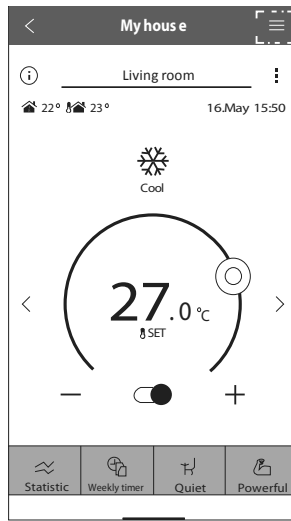

2. Select 'Menu'.

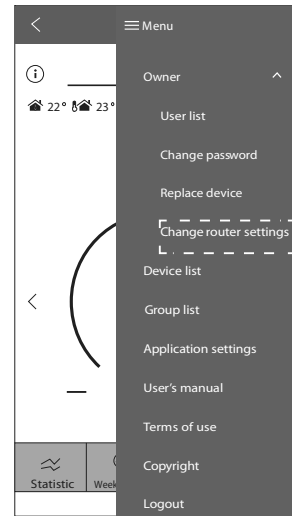

3. Select 'Change router setting'.

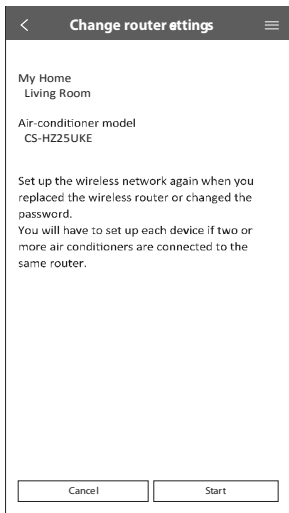

4. Select start button to proceed for network setting.

## 19.5.2.2 Initial Setup (Method 2)

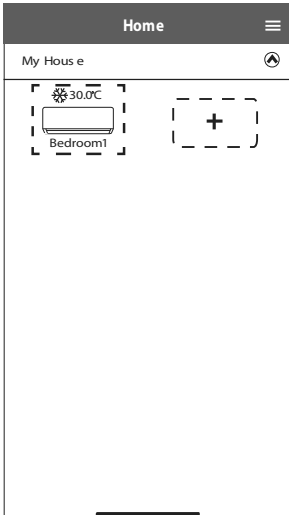

1. Select air-conditioner.

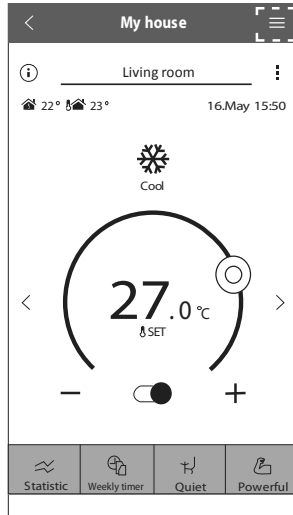

2. Select 'Menu'.

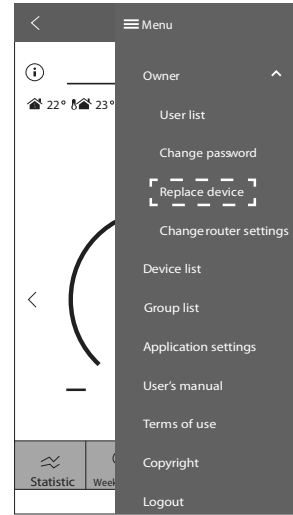

3. Select 'Replace device'.

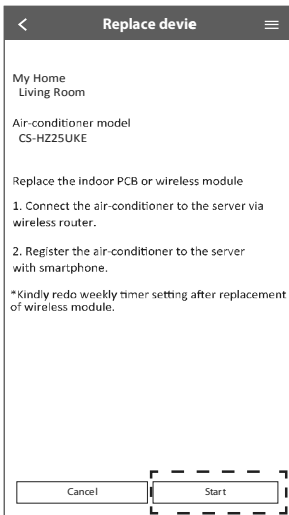

4. Select start button to proceed for network setting.

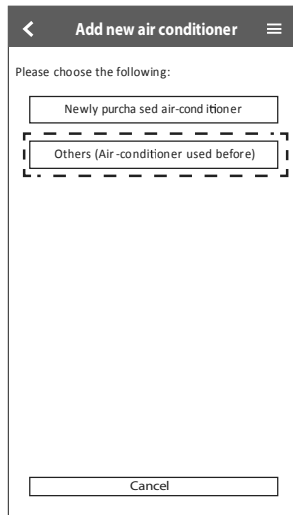

5. Select 'Others (Air-Conditioner used before)'

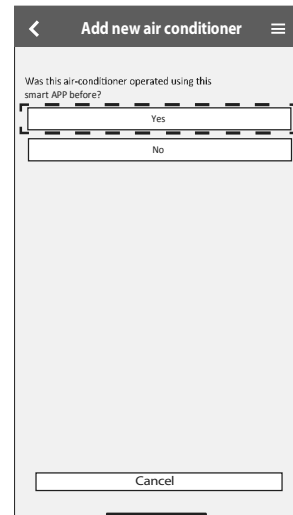

6. Select 'Yes'.

### 19.5.2.3 Setting Connection Network



1. Ensure Wireless LAN LED is ON. point the remote control to air conditioner and press Wireless LAN button until the Wireless LAN LED changed to blinking.

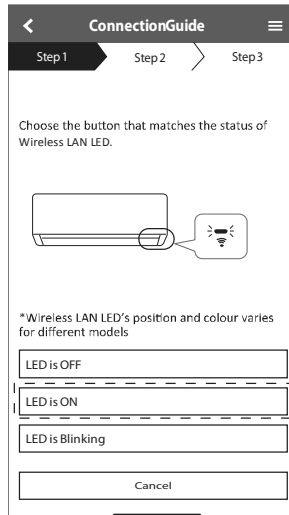

2. When Wireless LAN LED is blinking, select preferred connection setup mode.

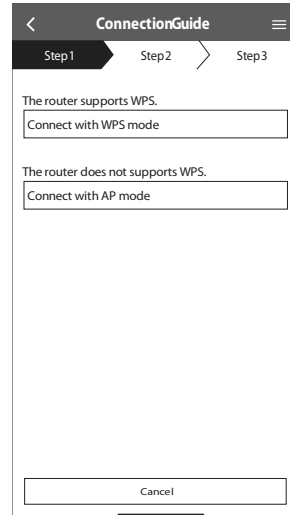

3. Select the preferred router support connectivity mode.

### 19.5.2.4 Connection Network Using WPS Mode (Method 1)

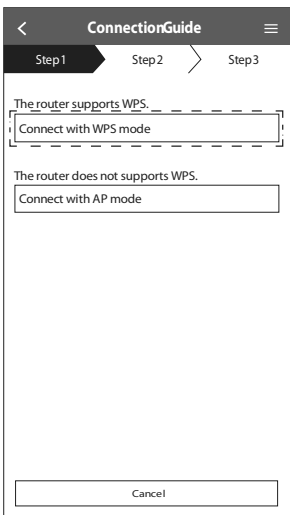

1. Select 'Connect with WPS mode'.

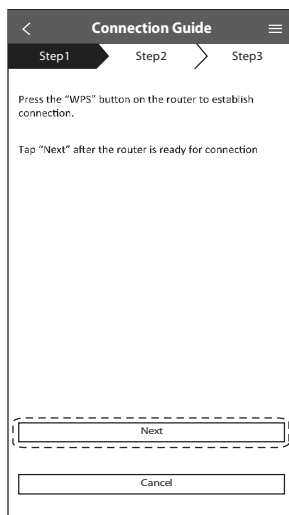

2. Press the "WPS" button from the router that will be connected to an air conditioner.
  - Check the status of Wireless LAN LED on the remote control. If the Wireless LAN LED is OFF, press the Wireless LAN button to enable the Wireless LAN connection.

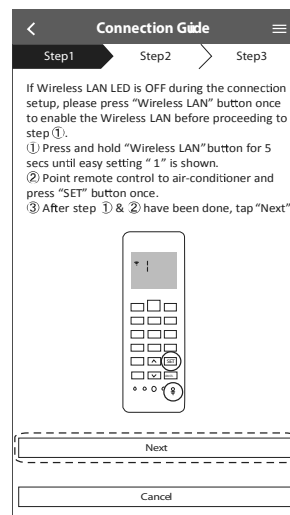

3. Ensure Wireless LAN LED is ON. Press and hold the Wireless LAN button for 5 seconds until "1" is shown on the remote control and press pointing to the air conditioner.

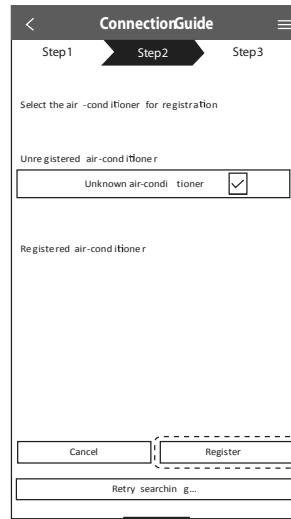
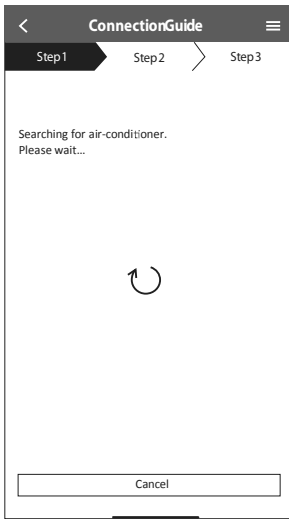

4. If the Wireless LAN LED keep blinking, check the wireless router connection.

5. Select the air conditioner model to register the device.

### 19.5.2.5 Connection Network Using AP Mode (Method 2)

\* (For Android 4.4 and above & iOS 11 and above only)

- ① Ensure Wireless LAN LED is ON. Press and hold the Wireless LAN button for 5 seconds until "1" is shown on the remote control. Press until "2" is shown on the remote control and press pointing to the air conditioner. Join to connect "Panasonic-CS-wirelessAP" network.

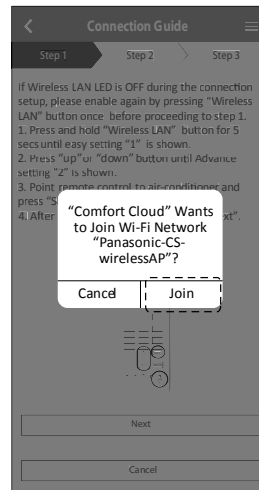
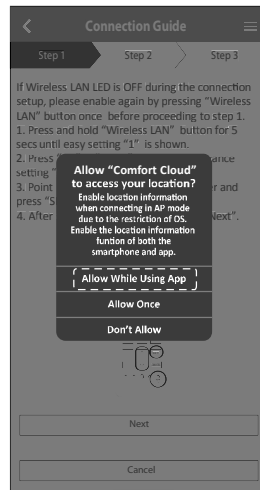
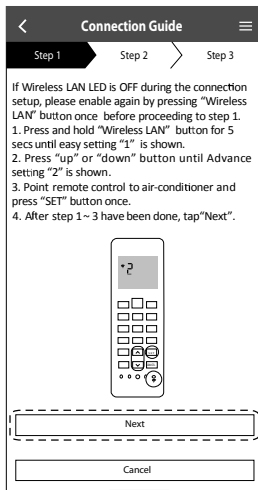

- ② Enter the password of the selected wireless router and continue.

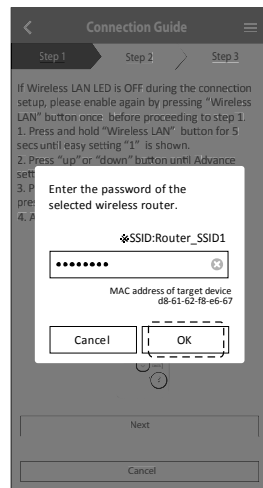

- ③ When connection of air conditioner to router is successful, the Wireless LAN LED will change from blinking to ON. If the Wireless LAN LED is ON, connect the smartphone to wireless router. (return to this application after completing the wireless network settings to continue the setup)
- If the Wireless LAN LED keep blinking, check the wireless router connection.

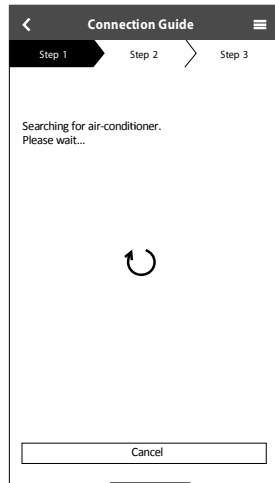
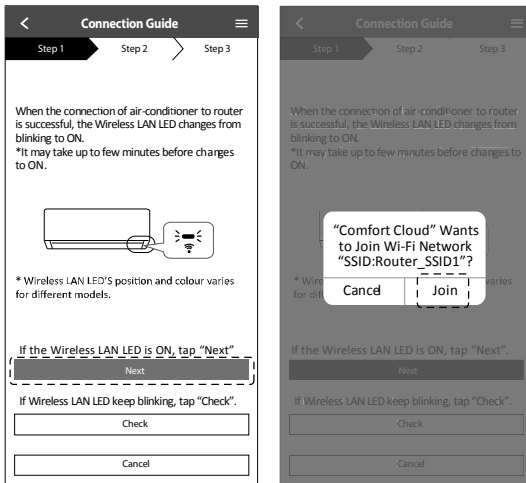

### 19.5.2.6 Select the Air Conditioner and Set the Password

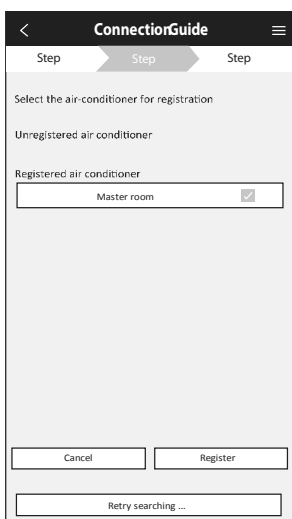

1. Select the air conditioner model to register the device.

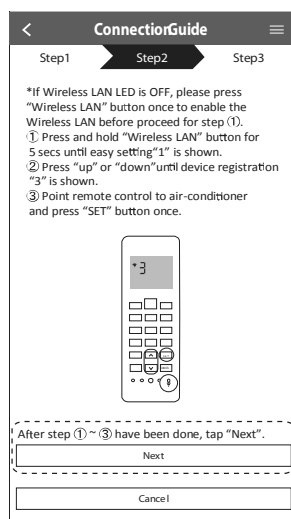

2. Set a password for new air conditioner model to complete the registration.

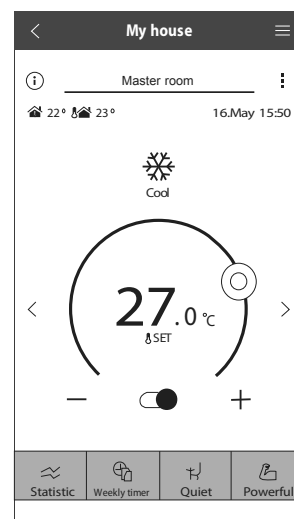

3. Setting completed.

## 20. Technical Data

Technical data provided are based on the air conditioner running under free frequency.

### 20.1 Cool Mode Performance Data - Sensible Capacity

Unit setting: Standard piping length, Hi Fan, Cool mode at 16°C

Voltage: 230V

#### 20.1.1 CS-TZ20WKEW CU-TZ20WKE

Indoor (°C)		Outdoor DB (°C)																				
DB	WB	-10			-5			0			5			16			25			35		
		TC	SHC	IP	TC	SHC	IP	TC	SHC	IP	TC	SHC	IP	TC	SHC	IP	TC	SHC	IP	TC	SHC	IP
27	19	2453	2166	279	2395	2146	338	2344	2132	365	2175	2050	419	2408	2159	296	2256	2084	385	2000	1978	490
	22	2613	1646	295	2505	1631	362	2531	1634	327	2489	1617	349	2565	1663	294	2444	1606	389	2223	1519	493
23	15.7	2280	2169	266	2194	2116	316	2017	1976	354	2010	1970	401	2170	2125	306	1967	1928	390	1781	1745	480
	18.4	2400	1647	276	2365	1674	335	2195	1574	384	2271	1601	339	2370	1670	301	2172	1553	390	1978	1478	489
20	13.3	1984	1945	196	2061	2020	295	1863	1826	331	1920	1881	319	2023	1983	310	1904	1866	390	1626	1594	475
	15.8	2272	1661	266	2207	1627	316	2033	1556	358	2031	1521	402	2184	1621	307	2004	1513	389	1787	1399	480

(Dry bulb value based on 46% humidity)

#### 20.1.2 CS-RZ20WKEW CU-RZ20WKE

Indoor (°C)		Outdoor DB (°C)																				
DB	WB	-10			-5			0			5			16			25			35		
		TC	SHC	IP	TC	SHC	IP	TC	SHC	IP	TC	SHC	IP	TC	SHC	IP	TC	SHC	IP	TC	SHC	IP
27	19	2441	2155	290	2383	2135	352	2333	2121	380	2164	2040	436	2396	2148	308	2245	2074	401	2000	1978	510
	22	2600	1637	307	2493	1622	376	2518	1626	341	2477	1609	364	2552	1654	306	2431	1598	405	2211	1511	514
23	15.7	2268	2159	276	2183	2106	328	2007	1967	369	2000	1960	417	2159	2115	318	1957	1918	406	1772	1737	500
	18.4	2388	1639	288	2353	1666	349	2184	1566	400	2260	1593	353	2359	1662	314	2161	1545	406	1968	1470	509
20	13.3	1974	1935	204	2051	2010	307	1854	1817	344	1910	1872	332	2013	1973	322	1894	1856	406	1618	1586	494
	15.8	2261	1653	277	2196	1619	329	2023	1548	373	2021	1514	418	2173	1613	319	1994	1505	405	1778	1392	500

(Dry bulb value based on 46% humidity)

#### 20.1.3 CS-TZ25WKEW CU-TZ25WKE

Indoor (°C)		Outdoor DB (°C)																				
DB	WB	-10			-5			0			5			16			25			35		
		TC	SHC	IP	TC	SHC	IP	TC	SHC	IP	TC	SHC	IP	TC	SHC	IP	TC	SHC	IP	TC	SHC	IP
27	19	3067	2571	370	2994	2548	449	2931	2531	484	2719	2434	556	3009	2563	392	2820	2475	511	2500	2348	650
	22	3266	1954	391	3132	1936	480	3163	1940	434	3112	1920	464	3206	1974	390	3055	1907	516	2778	1803	655
23	15.7	2850	2575	352	2742	2512	419	2521	2397	470	2512	2410	532	2712	2523	406	2459	2398	517	2226	2182	637
	18.4	2999	1955	366	2956	1987	445	2744	1869	509	2839	1901	450	2963	1983	400	2715	1843	518	2472	1754	648
20	13.3	2480	2396	260	2576	2472	391	2329	2314	439	2400	2364	424	2529	2419	411	2380	2346	518	2033	1992	630
	15.8	2841	1972	353	2759	1931	420	2541	1847	475	2539	1806	533	2730	1925	407	2505	1796	517	2234	1661	637

(Dry bulb value based on 46% humidity)

### 20.1.4 CS-RZ25WKEW CU-RZ25WKE

Indoor (°C)		Outdoor DB (°C)																				
DB	WB	-10			-5			0			5			16			25			35		
		TC	SHC	IP	TC	SHC	IP	TC	SHC	IP	TC	SHC	IP	TC	SHC	IP	TC	SHC	IP	TC	SHC	IP
27	19	3036	2546	375	2964	2522	456	2901	2506	491	2692	2410	565	2979	2538	398	2792	2450	519	2500	2347	660
	22	3234	1934	397	3100	1916	487	3132	1920	441	3081	1901	471	3174	1954	396	3024	1888	524	2750	1785	665
23	15.7	2821	2550	358	2715	2487	425	2496	2373	477	2487	2386	540	2685	2498	412	2434	2374	525	2204	2160	647
	18.4	2969	1936	372	2927	1968	451	2717	1850	517	2811	1882	457	2933	1963	406	2687	1825	526	2448	1737	658
20	13.3	2455	2372	264	2551	2447	397	2306	2291	445	2376	2340	430	2504	2395	417	2356	2322	526	2013	1972	639
	15.8	2812	1952	358	2731	1912	426	2516	1829	482	2513	1788	541	2703	1906	413	2480	1778	525	2211	1645	647

(Dry bulb value based on 46% humidity)

### 20.1.5 CS-TZ35WKEW CU-TZ35WKE

Indoor (°C)		Outdoor DB (°C)																				
DB	WB	-10			-5			0			5			16			25			35		
		TC	SHC	IP	TC	SHC	IP	TC	SHC	IP	TC	SHC	IP	TC	SHC	IP	TC	SHC	IP	TC	SHC	IP
27	19	3879	2948	719	3898	2967	715	3913	2923	719	3802	2941	837	4280	3175	571	3990	3103	758	3500	2878	980
	22	4279	2372	727	4211	2370	791	4232	2364	769	4401	2424	666	4714	2578	547	4372	2437	749	3898	2284	984
23	15.7	3465	2918	769	3491	2906	735	3456	2879	804	3478	2858	785	3856	3069	590	3577	2974	765	3164	2848	980
	18.4	3832	2353	719	3859	2348	696	3885	2364	719	3738	2322	820	4098	2459	576	3902	2426	759	3507	2276	981
20	13.3	3078	2730	880	3050	2694	735	3292	2861	770	3194	2761	803	3628	3066	603	3294	2900	768	2939	2717	978
	15.8	3496	2321	768	3487	2317	728	3466	2288	808	3399	2256	844	3814	2445	589	3553	2351	764	3188	2210	981

(Dry bulb value based on 46% humidity)

### 20.1.6 CS-RZ35WKEW CU-RZ35WKE

Indoor (°C)		Outdoor DB (°C)																				
DB	WB	-10			-5			0			5			16			25			35		
		TC	SHC	IP	TC	SHC	IP	TC	SHC	IP	TC	SHC	IP	TC	SHC	IP	TC	SHC	IP	TC	SHC	IP
27	19	3860	2933	733	3878	2952	729	3894	2909	733	3783	2926	854	4258	3159	583	3970	3088	774	3500	2849	1000
	22	4258	2360	742	4190	2358	807	4211	2352	784	4379	2412	680	4690	2565	558	4350	2424	764	3879	2273	1004
23	15.7	3448	2904	785	3474	2892	750	3439	2865	821	3460	2843	801	3837	3053	602	3559	2959	781	3148	2834	1000
	18.4	3812	2341	734	3839	2337	710	3865	2352	734	3720	2311	836	4078	2446	588	3882	2414	775	3490	2264	1001
20	13.3	3062	2716	898	3034	2681	750	3276	2846	785	3178	2747	820	3609	3050	616	3278	2886	784	2924	2703	998
	15.8	3478	2310	784	3469	2305	743	3449	2276	824	3382	2244	861	3795	2432	601	3535	2340	780	3172	2199	1001

(Dry bulb value based on 46% humidity)

### 20.1.7 CS-TZ42WKEW CU-TZ42WKE

Indoor (°C)		Outdoor DB (°C)																				
DB	WB	-10			-5			0			5			16			25			35		
		TC	SHC	IP	TC	SHC	IP	TC	SHC	IP	TC	SHC	IP	TC	SHC	IP	TC	SHC	IP	TC	SHC	IP
27	19	4763	3259	954	4840	3292	871	4731	3290	884	4603	3316	927	4985	3414	780	4567	3296	990	4200	3013	1250
	22	5273	2643	852	5139	2607	938	5149	2629	825	4959	2567	962	5372	2714	784	4968	2564	992	4295	2341	1254
23	15.7	3959	3168	1008	4203	3176	945	4315	3300	858	4173	3234	943	4591	3365	784	4157	3153	989	3728	2879	1227
	18.4	4661	2561	936	4639	2588	934	4635	2584	871	4444	2559	973	4849	2678	792	4457	2535	997	3950	2336	1245
20	13.3	3311	2854	761	3633	2857	757	3513	2925	717	3660	3020	889	3607	2989	614	3681	3129	979	3305	2815	1216
	15.8	4031	2459	1007	4195	2523	970	4299	2559	904	3991	2447	1027	4340	2604	773	4010	2471	983	3571	2283	1228

(Dry bulb value based on 46% humidity)

### 20.1.8 CS-TZ50WKEW CU-TZ50WKE CS-RZ50WKEW CU-RZ50WKE

Indoor (°C)		Outdoor DB (°C)																				
DB	WB	-10			-5			0			5			16			25			35		
		TC	SHC	IP	TC	SHC	IP	TC	SHC	IP	TC	SHC	IP	TC	SHC	IP	TC	SHC	IP	TC	SHC	IP
27	19	5403	3622	1174	5428	3645	1167	5450	3592	1174	5295	3613	1366	5961	3900	933	5557	3812	1238	5000	3627	1600
	22	5960	2914	1187	5865	2911	1291	5894	2905	1255	6130	2979	1088	6565	3168	893	6089	2993	1223	5429	2806	1607
23	15.7	4826	3585	1256	4862	3571	1200	4813	3537	1313	4843	3511	1281	5370	3770	964	4981	3653	1250	4406	3499	1600
	18.4	5336	2890	1174	5374	2885	1136	5410	2904	1174	5206	2853	1338	5708	3021	940	5434	2981	1240	4884	2796	1602
20	13.3	4286	3354	1436	4247	3310	1201	4585	3514	1257	4449	3392	1311	5052	3766	985	4588	3563	1254	4093	3338	1597
	15.8	4869	2852	1254	4856	2846	1189	4827	2811	1319	4734	2771	1378	5312	3003	962	4949	2889	1248	4439	2716	1601

(Dry bulb value based on 46% humidity)

### 20.1.9 CS-TZ60WKEW CU-TZ60WKE

Indoor (°C)		Outdoor DB (°C)																				
DB	WB	-10			-5			0			5			16			25			35		
		TC	SHC	IP	TC	SHC	IP	TC	SHC	IP	TC	SHC	IP	TC	SHC	IP	TC	SHC	IP	TC	SHC	IP
27	19	6590	5003	1591	6733	5116	1522	6685	4986	1536	6679	5040	1529	7343	5329	1219	6788	5135	1516	6000	4898	1850
	22	7522	3888	1423	7292	3856	1535	7520	3936	1450	7318	3873	1622	8027	4104	1210	7398	3871	1522	6688	3648	1891
23	15.7	6214	4958	1483	6081	4905	1482	6026	5053	1571	6049	5001	1485	6573	5246	1207	6053	5033	1498	5363	4698	1816
	18.4	6798	3929	1499	6627	3925	1495	6693	3836	1515	6522	3913	1535	7223	4047	1218	6656	3904	1508	5881	3632	1822
20	13.3	4953	4505	1235	5572	4692	1641	5199	4783	1549	4841	4540	1700	5581	4704	1132	5682	4817	1466	5092	4422	1801
	15.8	5887	3689	1673	6083	3735	1583	5542	3750	1583	5793	3814	1483	6698	4021	1215	6144	3801	1495	5419	3529	1802

(Dry bulb value based on 46% humidity)

### 20.1.10 CS-TZ71WKEW CU-TZ71WKE

Indoor (°C)		Outdoor DB (°C)																				
DB	WB	-10			-5			0			5			16			25			35		
		TC	SHC	IP	TC	SHC	IP	TC	SHC	IP	TC	SHC	IP	TC	SHC	IP	TC	SHC	IP	TC	SHC	IP
27	19	7776	5694	1648	7976	5728	1491	8000	5763	1509	7891	5749	1467	8070	5782	1385	7492	5511	1752	7100	5498	2240
	22	8807	4648	1453	8899	4664	1364	8663	4602	1561	8554	4500	1547	8873	4608	1323	8223	4355	1776	7577	4169	2268
23	15.7	7274	5692	1494	7329	5739	1384	7079	5589	1548	7290	5722	1427	7021	5489	1430	6716	5281	1768	6257	5305	2240
	18.4	7876	4624	1409	7929	4641	1476	7625	4499	1639	7904	4603	1477	7714	4395	1393	7338	4337	1800	6817	4154	2261
20	13.3	5643	4968	1229	5615	5031	1315	5316	4983	1027	4806	4486	832	6840	6703	1462	6185	5151	1775	5812	5060	2235
	15.8	7080	4439	1616	6015	3932	1288	6216	3964	1234	5538	3738	879	7180	4369	1425	6683	4203	1812	6196	4035	2261

(Dry bulb value based on 46% humidity)

TC - Total Cooling Capacity (W)  
 SHC - Sensible Heat Capacity (W)  
 IP - Input Power (W)

## 20.2 Heat Mode Performance Data

Unit setting: Standard piping length, Hi Fan, Heat mode at 30°C  
Voltage: 230V

### 20.2.1 CS-TZ20WKEW CU-TZ20WKE

Indoor (°C)	Outdoor WB (°C)									
DB	-15		-7		2		7		12	
	TC	IP	TC	IP	TC	IP	TC	IP	TC	IP
24	1614	751	2105	852	2500	891	2501	649	2720	669
20	1628	721	2140	840	2610	900	2700	650	2879	655
16	1573	739	2179	827	2747	885	2683	645	3088	656

### 20.2.2 CS-RZ20WKEW CU-RZ20WKE

Indoor (°C)	Outdoor WB (°C)									
DB	-15		-7		2		7		12	
	TC	IP	TC	IP	TC	IP	TC	IP	TC	IP
24	1598	751	2084	872	2475	911	2476	669	2692	689
20	1612	721	2140	860	2610	920	2700	670	2850	675
16	1558	739	2157	847	2720	905	2656	665	3057	676

### 20.2.3 CS-TZ25WKEW CU-TZ25WKE

Indoor (°C)	Outdoor WB (°C)									
DB	-15		-7		2		7		12	
	TC	IP	TC	IP	TC	IP	TC	IP	TC	IP
24	2056	870	2655	1025	2844	981	3057	789	3324	813
20	2074	836	2700	1010	2970	990	3300	790	3518	796
16	2004	856	2749	994	3126	974	3279	784	3774	797

### 20.2.4 CS-RZ25WKEW CU-RZ25WKE

Indoor (°C)	Outdoor WB (°C)									
DB	-15		-7		2		7		12	
	TC	IP	TC	IP	TC	IP	TC	IP	TC	IP
24	2035	870	2629	1035	2816	991	3027	799	3291	823
20	2053	836	2700	1020	2970	1000	3300	800	3483	806
16	1984	856	2722	1004	3095	984	3246	794	3736	807

### 20.2.5 CS-TZ35WKEW CU-TZ35WKE

Indoor (°C)	Outdoor WB (°C)									
DB	-15		-7		2		7		12	
	TC	IP	TC	IP	TC	IP	TC	IP	TC	IP
24	2696	1237	3004	1318	3594	1192	3642	992	3877	986
20	2700	1170	3300	1310	3700	1220	4000	990	4033	986
16	2544	1107	3403	1254	3724	1161	4164	989	4275	984

### 20.2.6 CS-RZ35WKEW CU-RZ35WKE

Indoor (°C)	Outdoor WB (°C)									
DB	-15		-7		2		7		12	
	TC	IP	TC	IP	TC	IP	TC	IP	TC	IP
24	2682	1243	2989	1359	3576	1231	3623	1052	3857	1046
20	2700	1176	3300	1350	3700	1260	4000	1050	4013	1046
16	2532	1113	3386	1292	3705	1199	4142	1049	4253	1044

### 20.2.7 CS-TZ42WKEW CU-TZ42WKE

Indoor (°C)	Outdoor WB (°C)									
	-15		-7		2		7		12	
	TC	IP	TC	IP	TC	IP	TC	IP	TC	IP
24	3064	1513	3874	1772	4697	1823	4728	1340	5082	1353
20	3092	1404	3900	1700	4930	1810	5000	1340	5290	1349
16	3217	1395	4103	1629	4918	1789	5266	1339	5558	1349

### 20.2.8 CS-TZ50WKEW CU-TZ50WKE CS-RZ50WKEW CU-RZ50WKE

Indoor (°C)	Outdoor WB (°C)									
	-15		-7		2		7		12	
	TC	IP	TC	IP	TC	IP	TC	IP	TC	IP
24	3656	1872	4205	2013	5275	1992	5254	1703	5593	1694
20	3662	1771	4620	2000	5430	2040	5800	1700	5818	1694
16	3451	1676	4765	1915	5465	1941	6006	1698	6166	1691

### 20.2.9 CS-TZ60WKEW CU-TZ60WKE

Indoor (°C)	Outdoor WB (°C)									
	-15		-7		2		7		12	
	TC	IP	TC	IP	TC	IP	TC	IP	TC	IP
24	3596	1631	4767	2051	5827	2053	6904	1911	7116	1933
20	3666	1562	4900	1950	5940	2040	7000	1900	7213	1903
16	3833	1551	4938	1847	6119	1937	7247	1830	7778	1914

### 20.2.10 CS-TZ71WKEW CU-TZ71WKE

Indoor (°C)	Outdoor WB (°C)									
	-15		-7		2		7		12	
	TC	IP	TC	IP	TC	IP	TC	IP	TC	IP
24	4509	2082	5558	2485	6902	2532	7665	2449	7883	2438
20	4660	2006	6130	2480	7170	2520	8600	2450	8528	2438
16	5035	1899	6340	2475	7697	2140	8047	2437	9121	2448

TC - Total Cooling Capacity (W)

IP - Input Power (W)

## 21. Service Data

Service data provided are based on the air conditioner running under rated frequency during forced cooling / forced heating mode.

### 21.1 Cool Mode Outdoor Air Temperature Characteristic

Condition

- Indoor room temperature: 27°C Dry Bulb/19°C Wet Bulb
- Unit setting: Standard piping length, forced cooling at 16°C, Hi fan
- Compressor frequency: Rated for cooling operation
- Piping length: 5m
- Voltage: 230V

#### 21.1.1 CS-TZ20WKEW CU-TZ20WKE

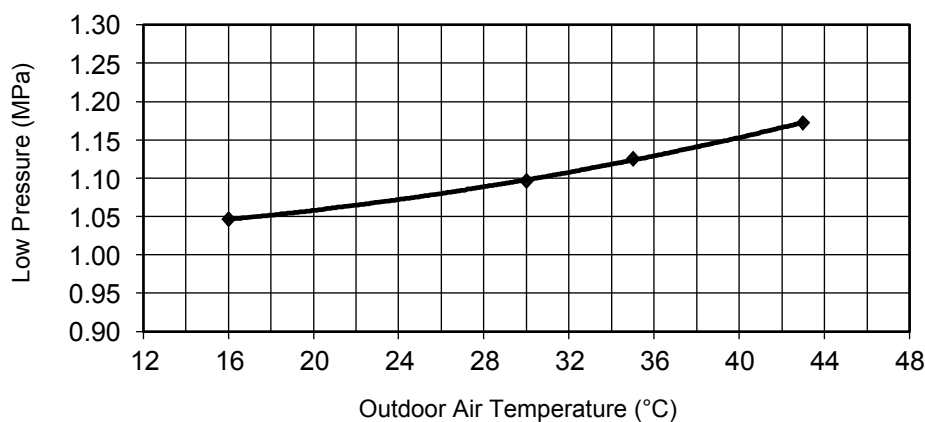
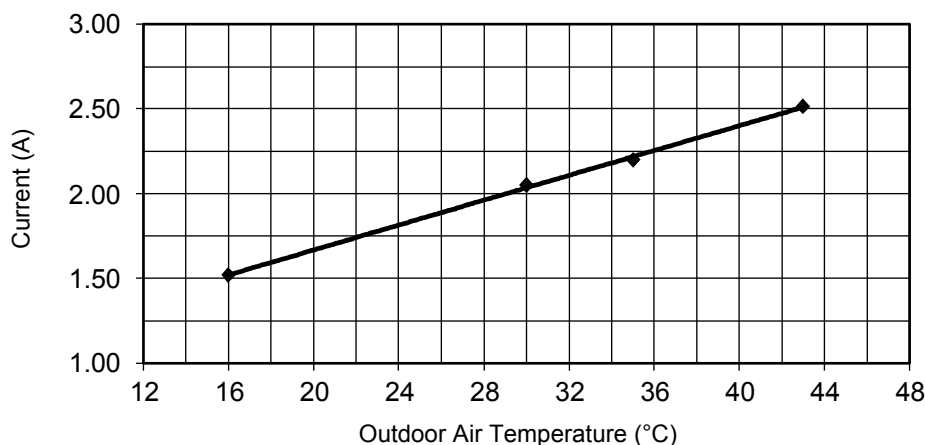
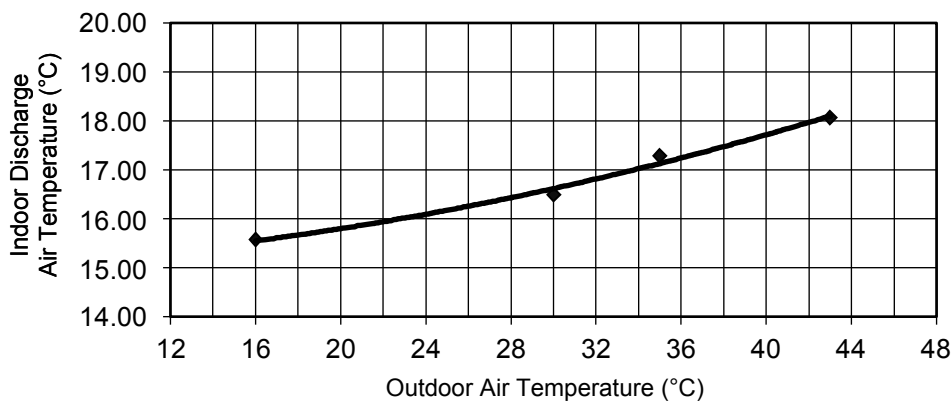

### 21.1.2 CS-RZ20WKEW CU-RZ20WKE

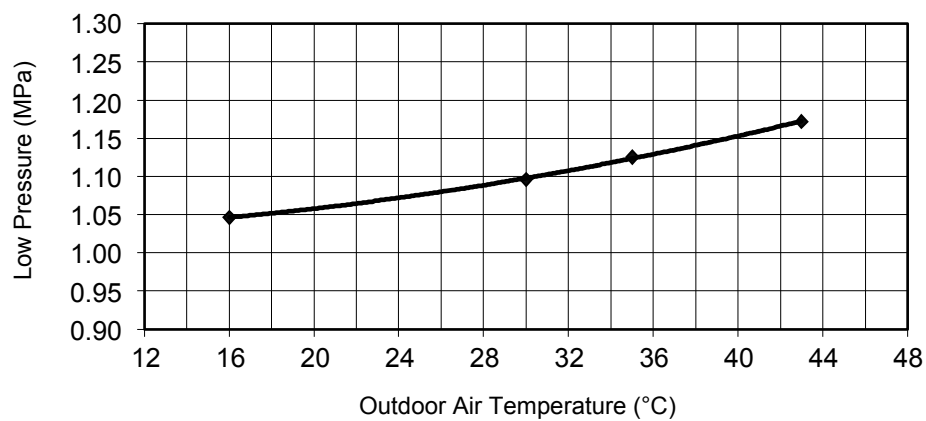
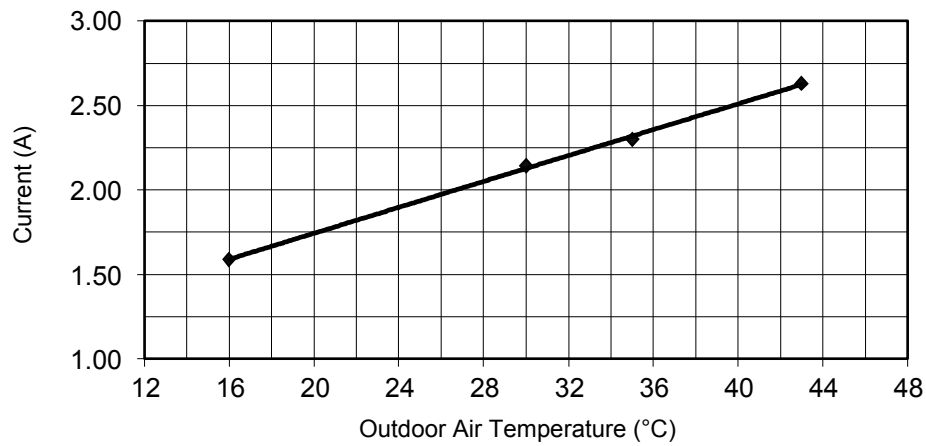
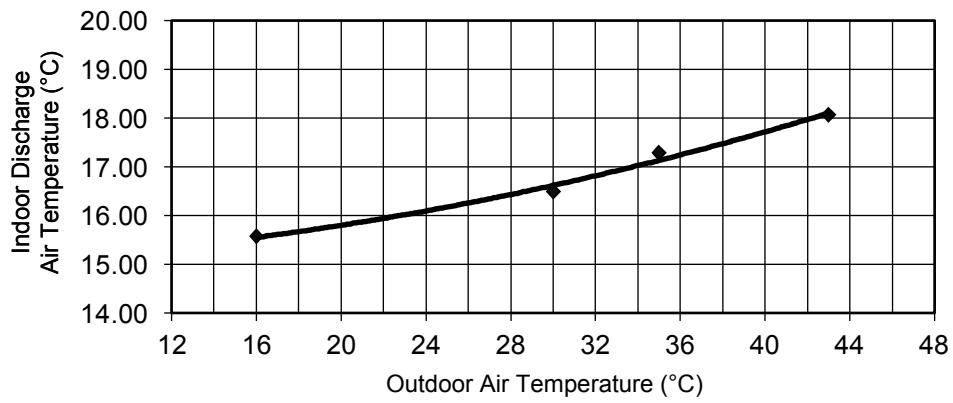

### 21.1.3 CS-TZ25WKEW CU-TZ25WKE

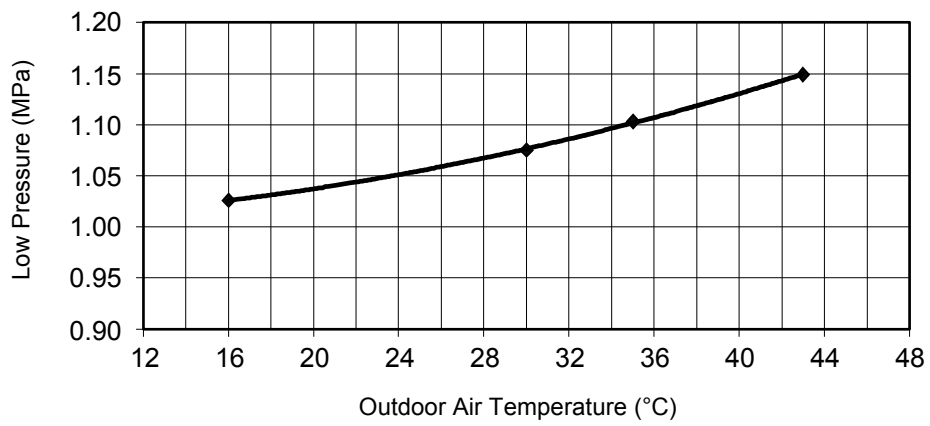
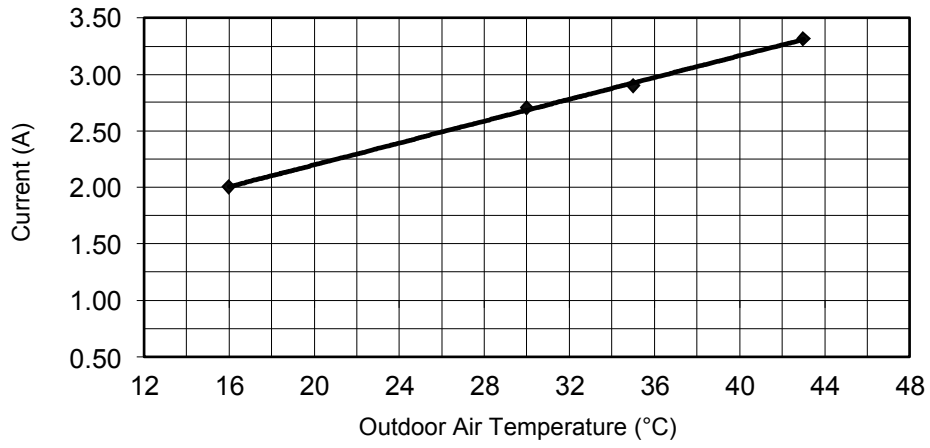
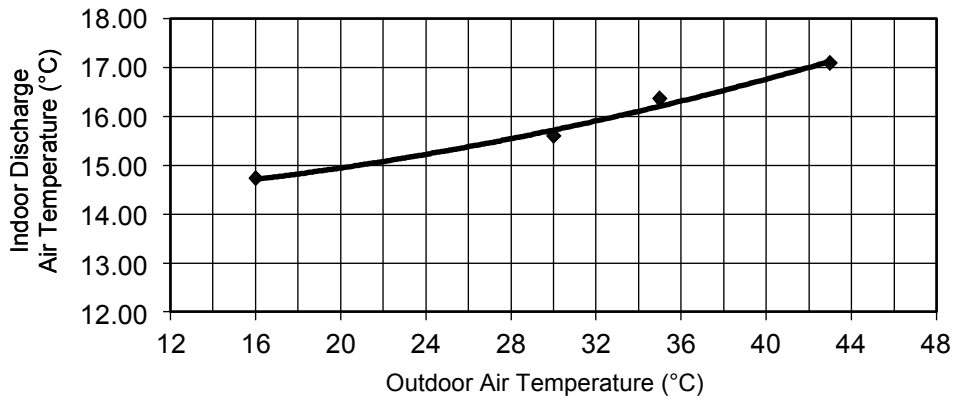

### 21.1.4 CS-RZ25WKEW CU-RZ25WKE

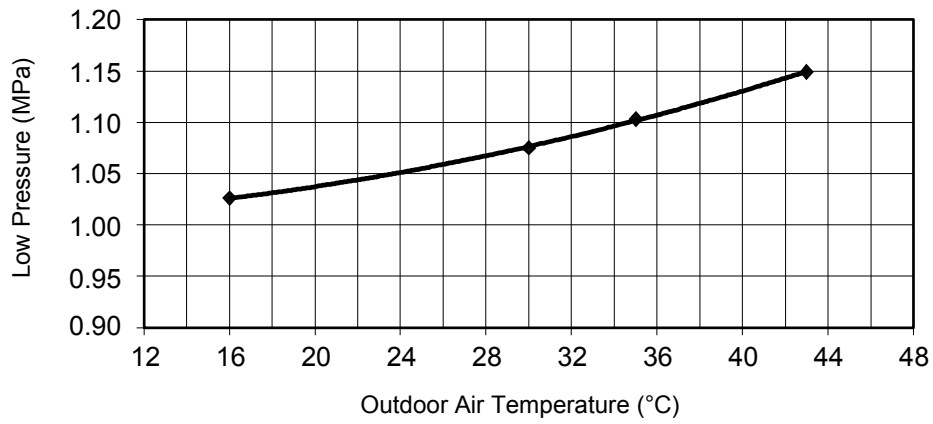
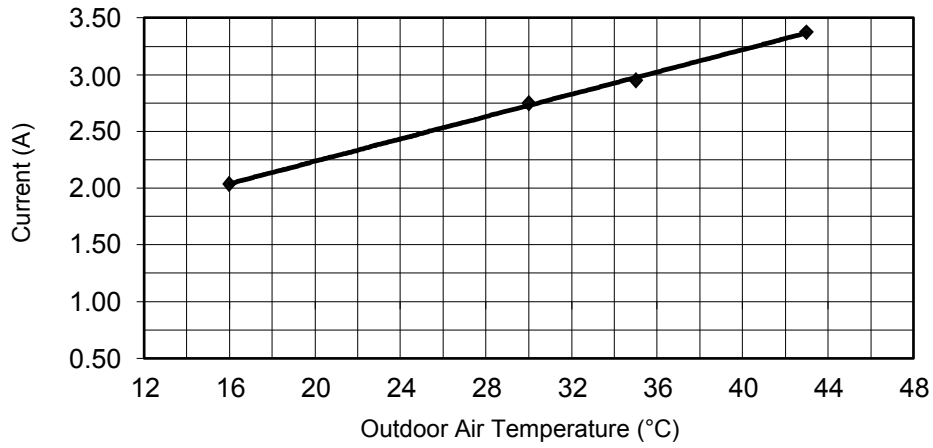
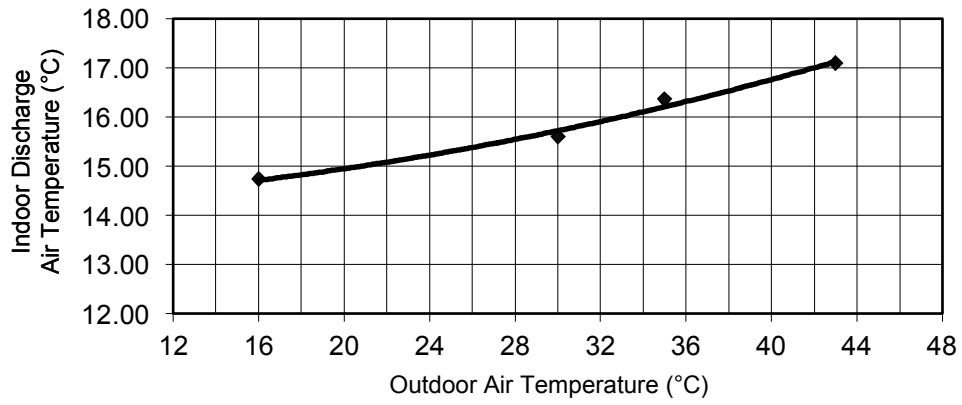

### 21.1.5 CS-TZ35WKEW CU-TZ35WKE

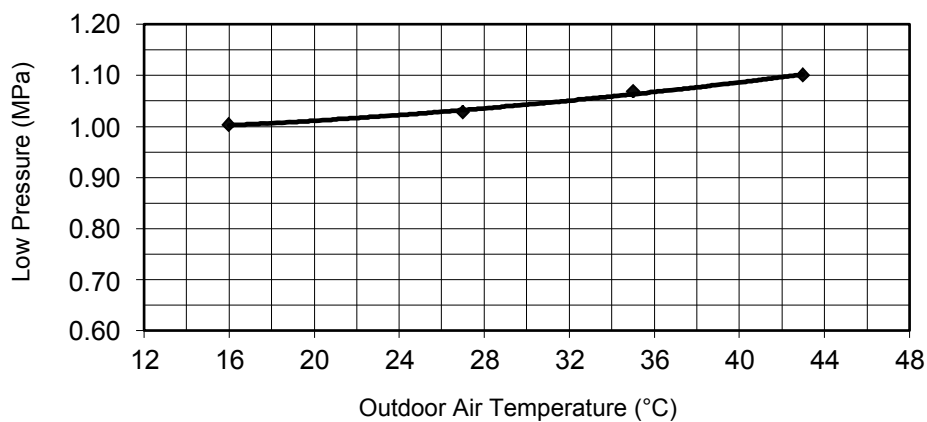
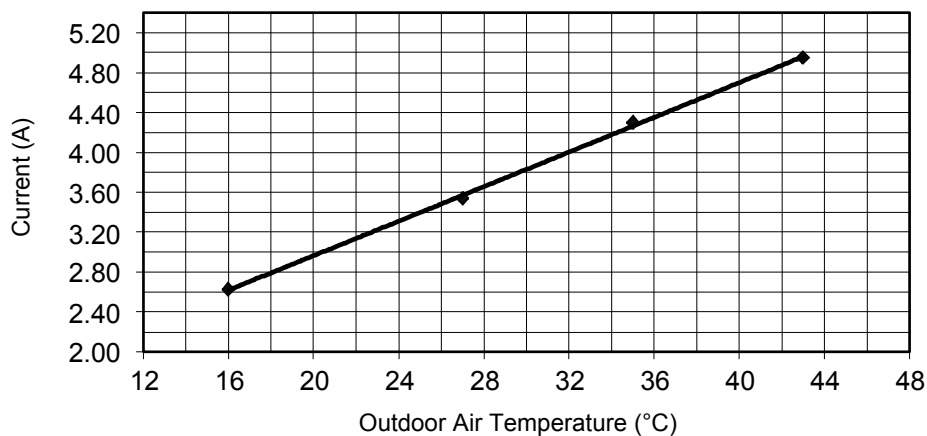
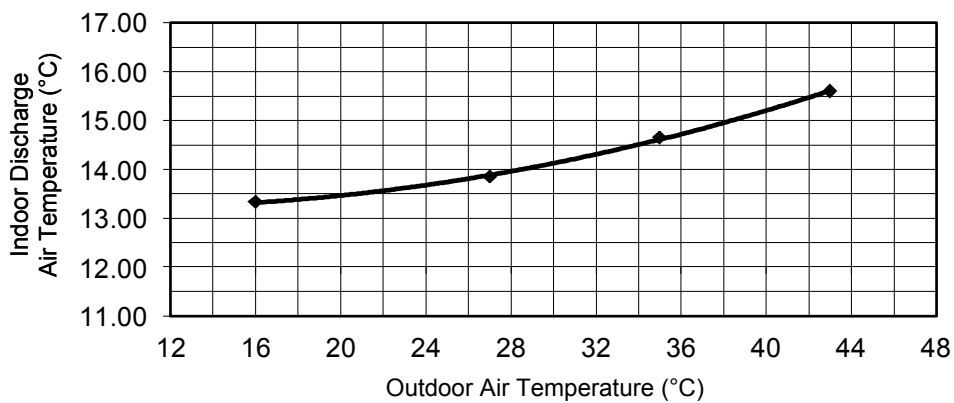

### 21.1.6 CS-RZ35WKEW CU-RZ35WKE

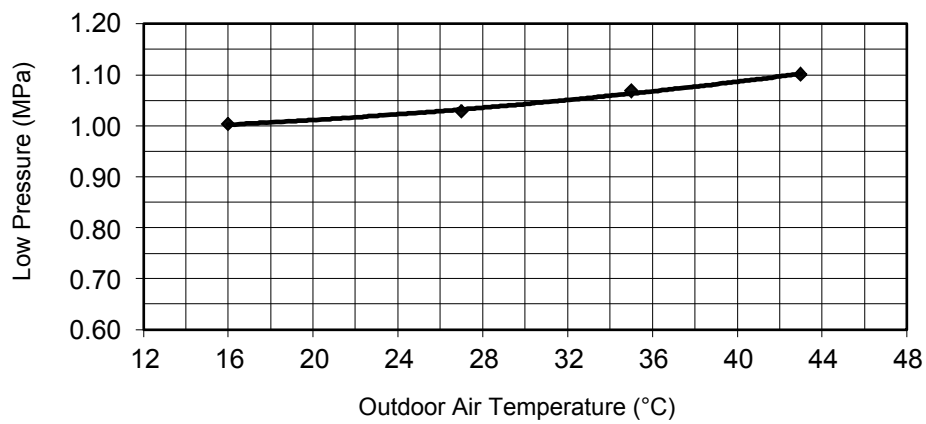
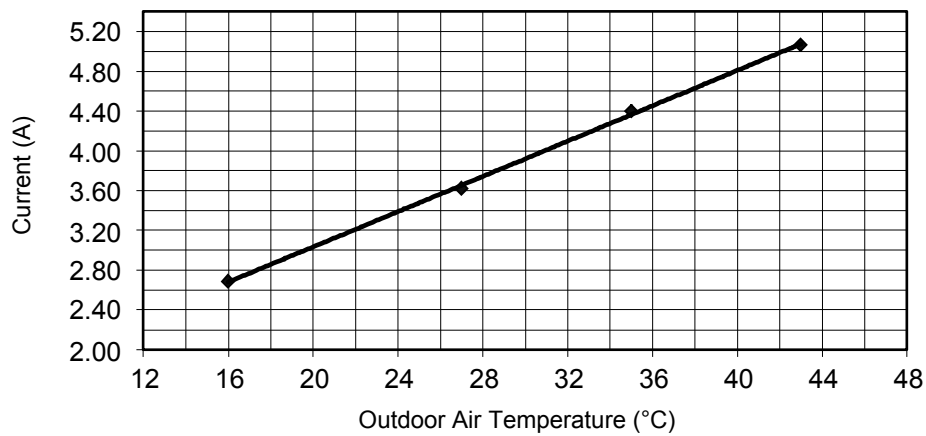
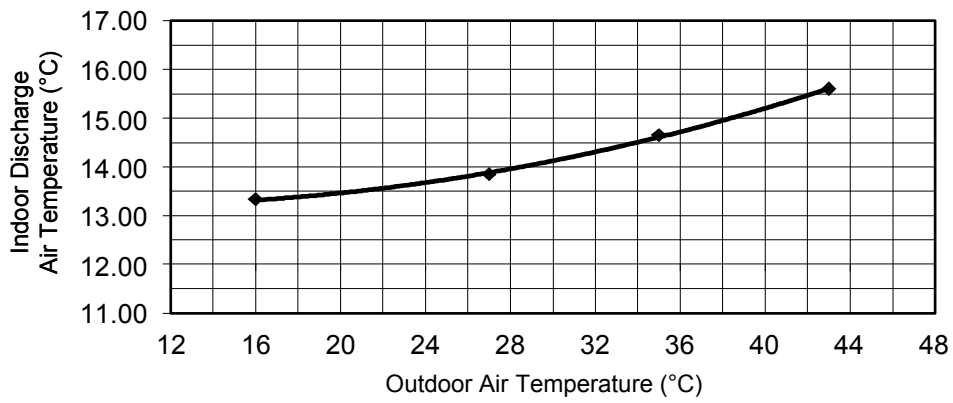

### 21.1.7 CS-TZ42WKEW CU-TZ42WKE

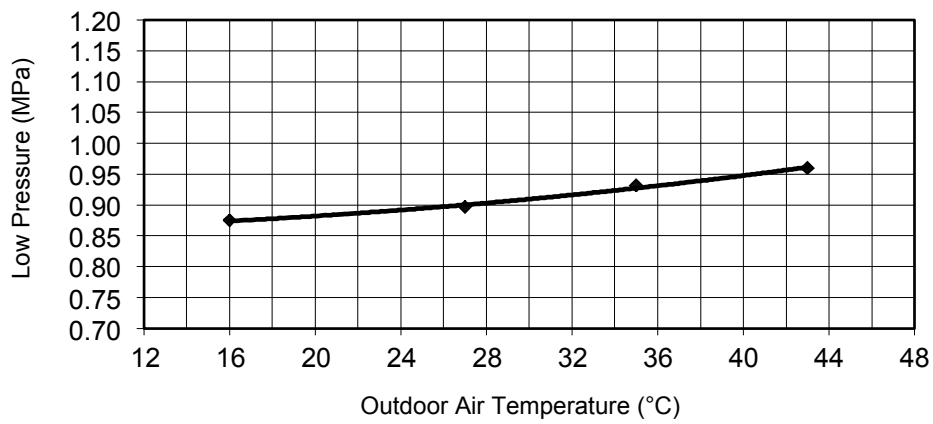
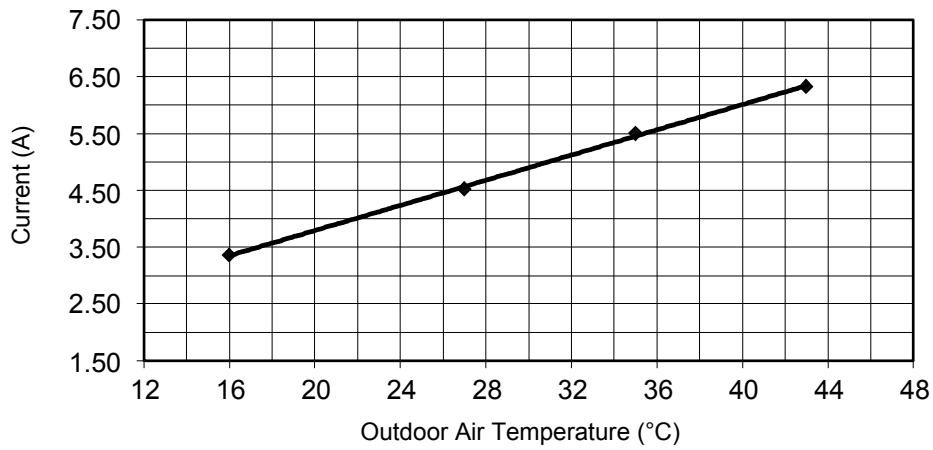
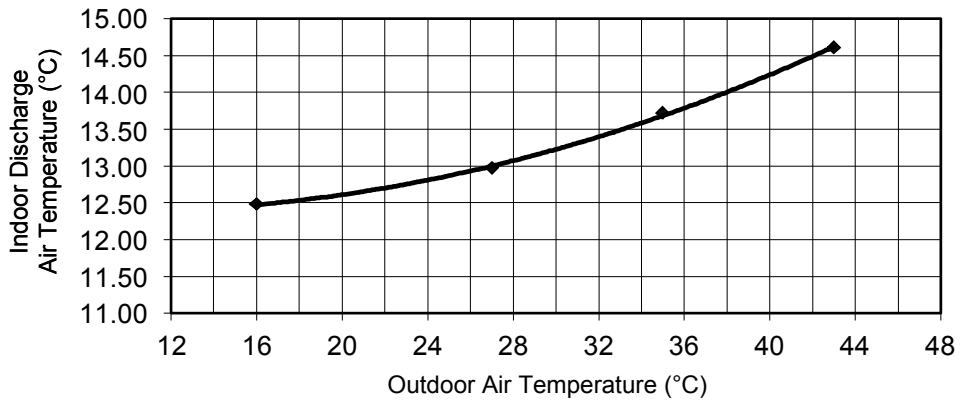

21.1.8 CS-TZ50WKEW CU-TZ50WKE CS-RZ50WKEW CU-RZ50WKE

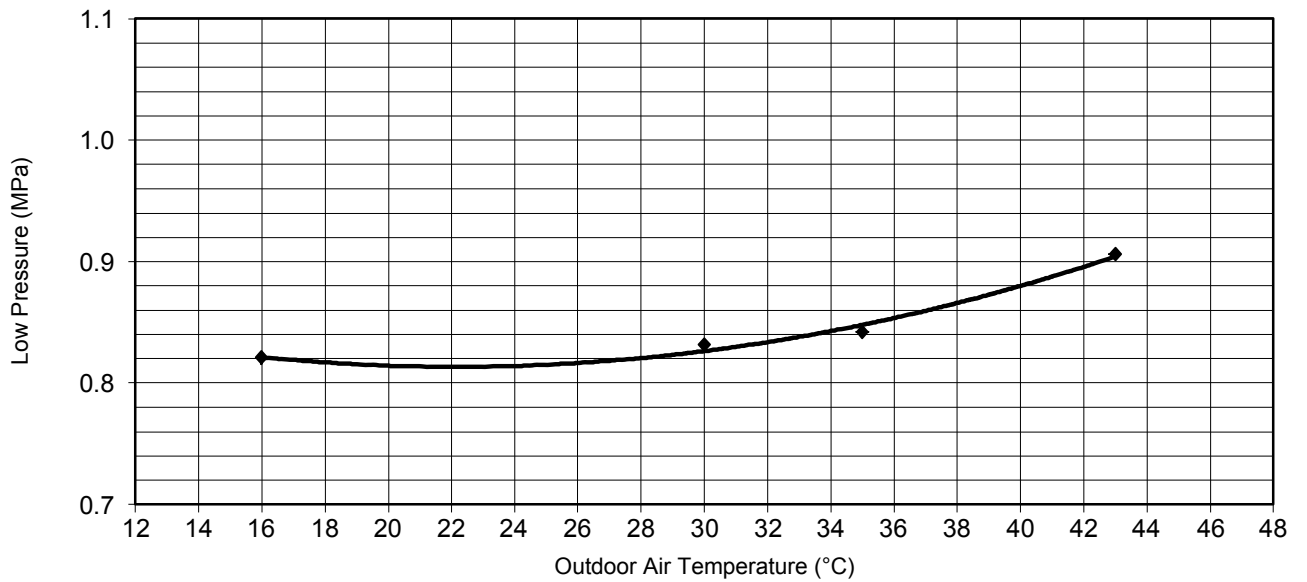
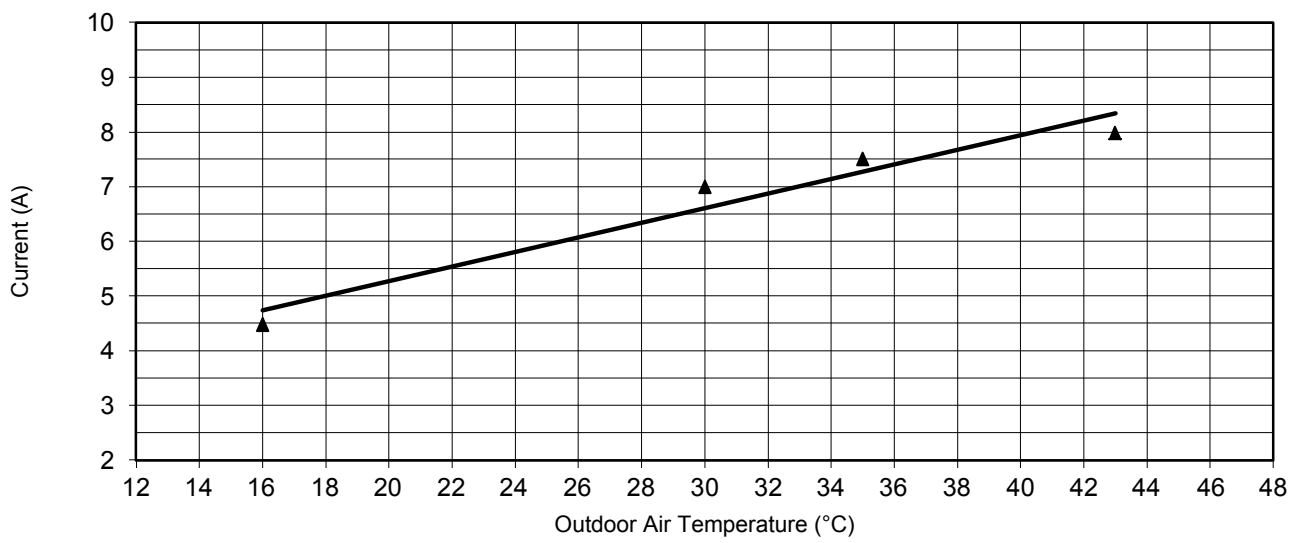
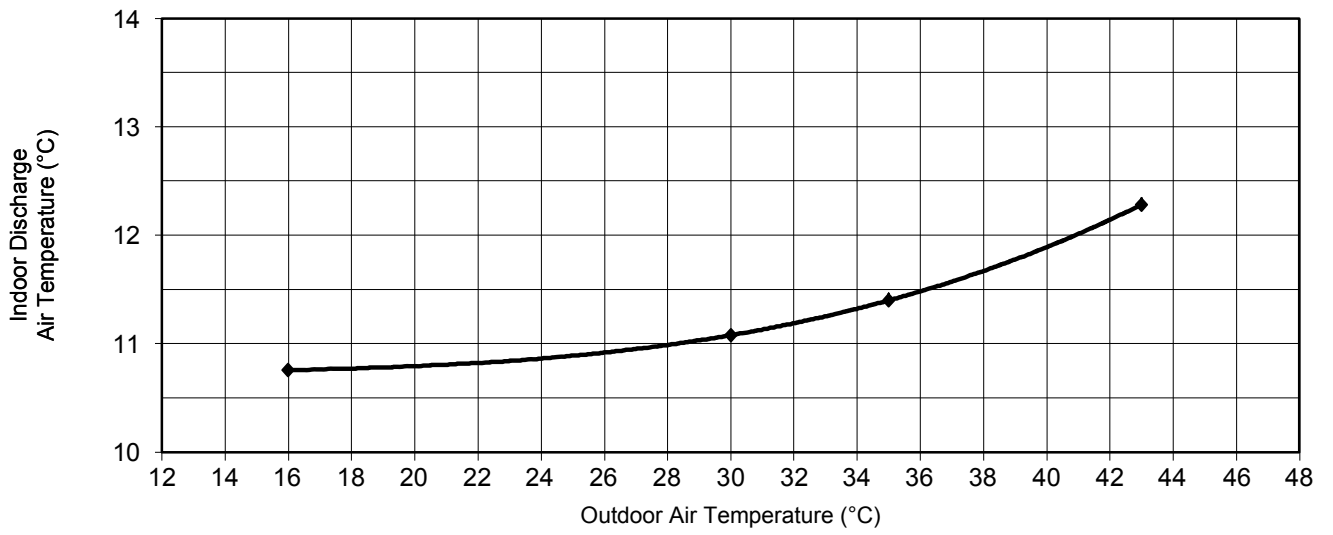

### 21.1.9 CS-TZ60WKEW CU-TZ60WKE

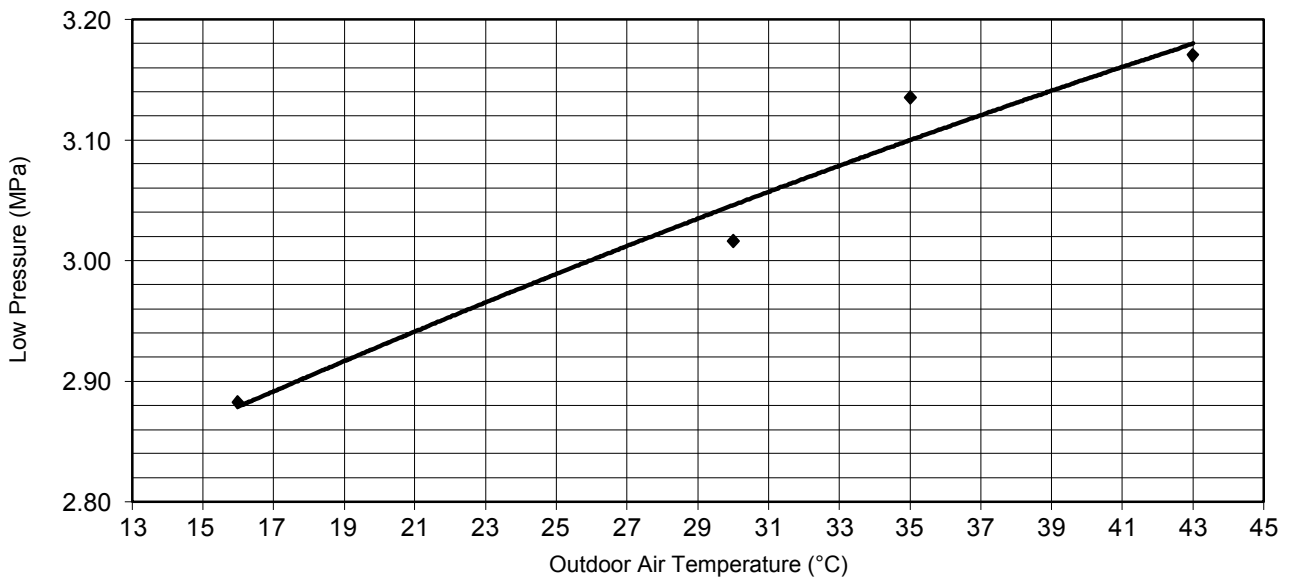
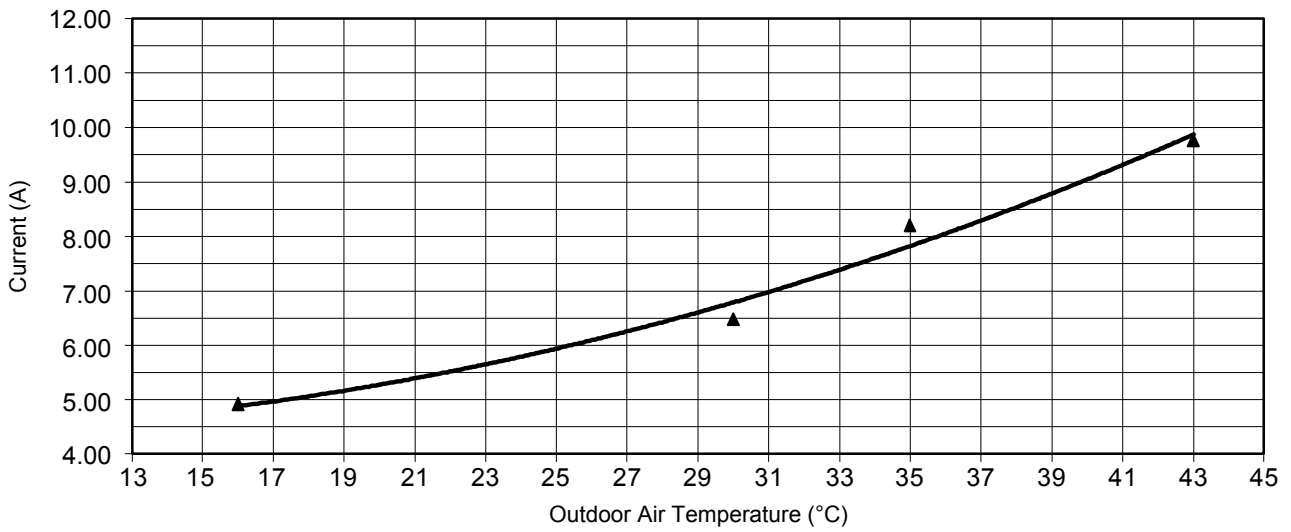
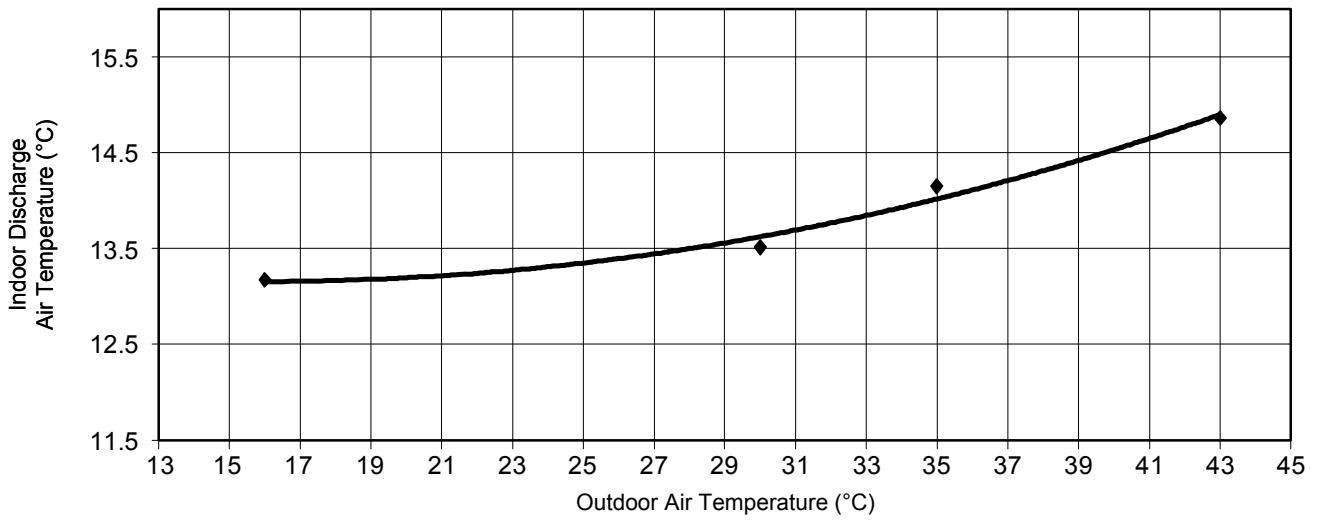

### 21.1.10 CS-TZ71WKEW CU-TZ71WKE

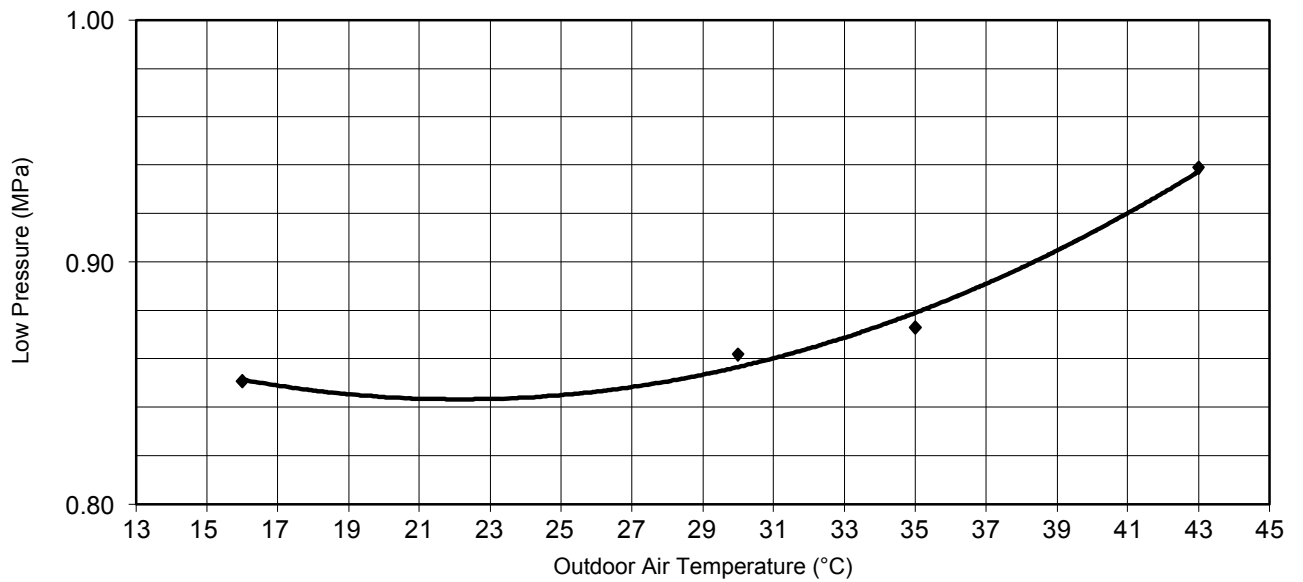
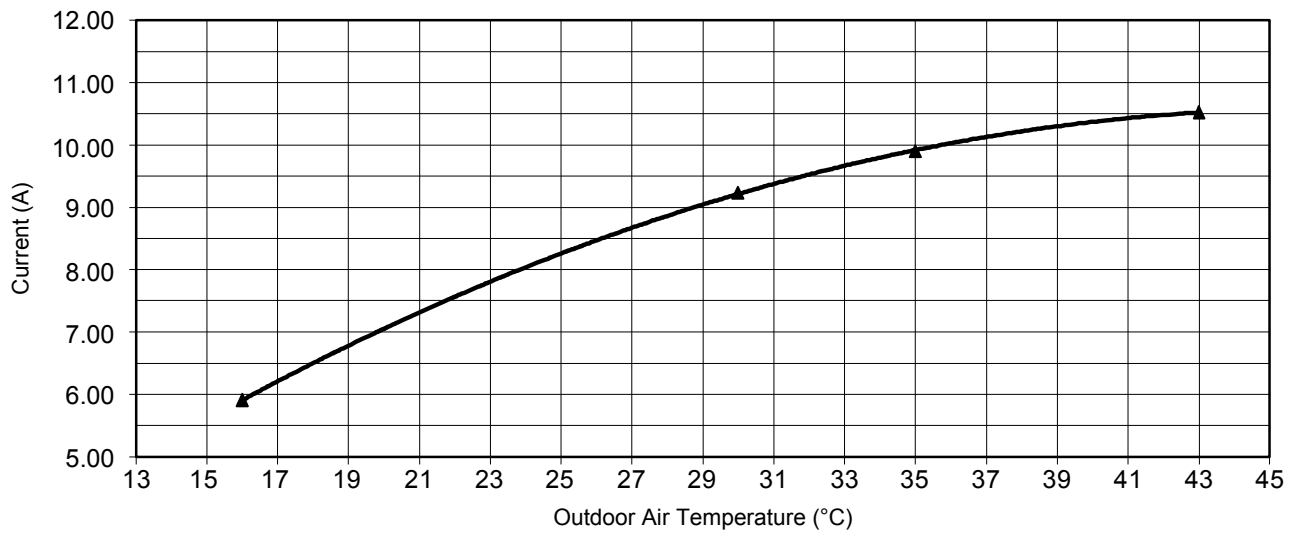
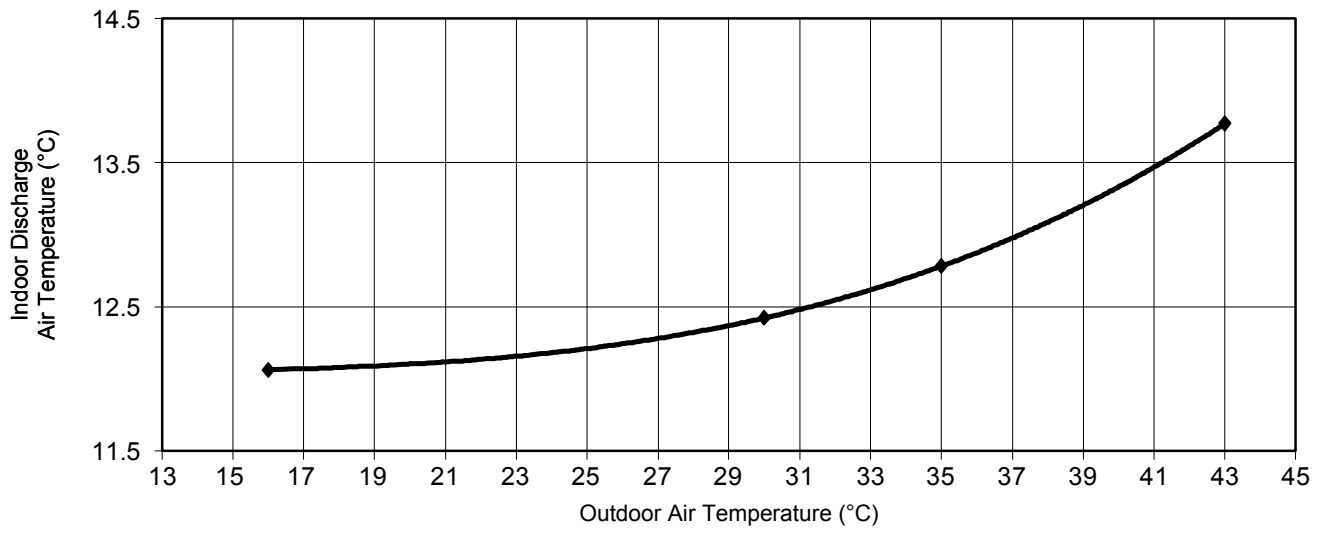

## 21.2 Heat Mode Outdoor Air Temperature Characteristic

### Condition

- Indoor room temperature: 20°C Dry Bulb/ -°C Wet Bulb
- Unit setting: Standard piping length, forced heating at 30°C, Hi fan
- Compressor frequency: Rated for Heating operation
- Piping length: 5m
- Voltage: 230V

### 21.2.1 CS-TZ20WKEW CU-TZ20WKE

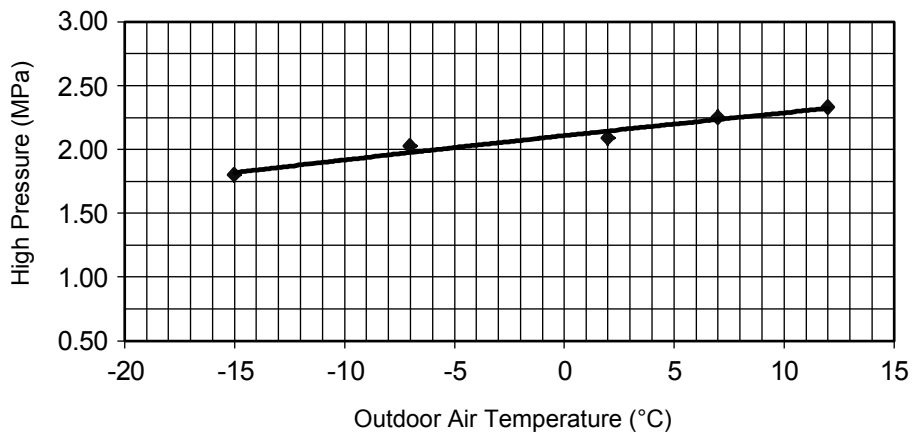
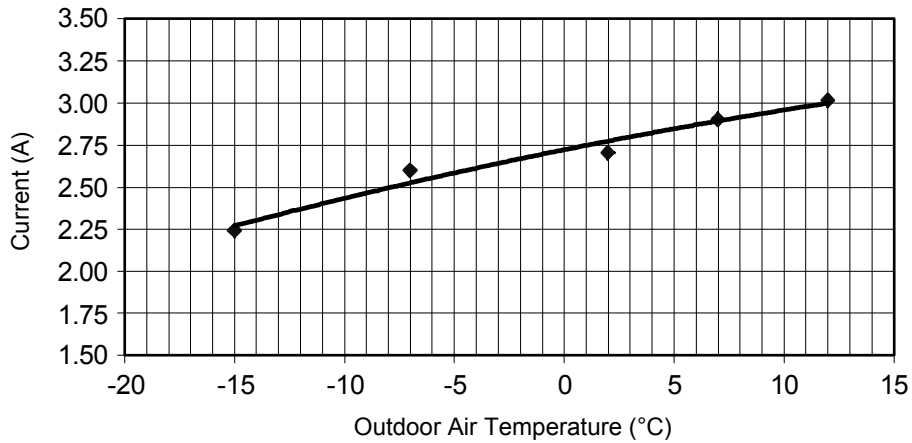
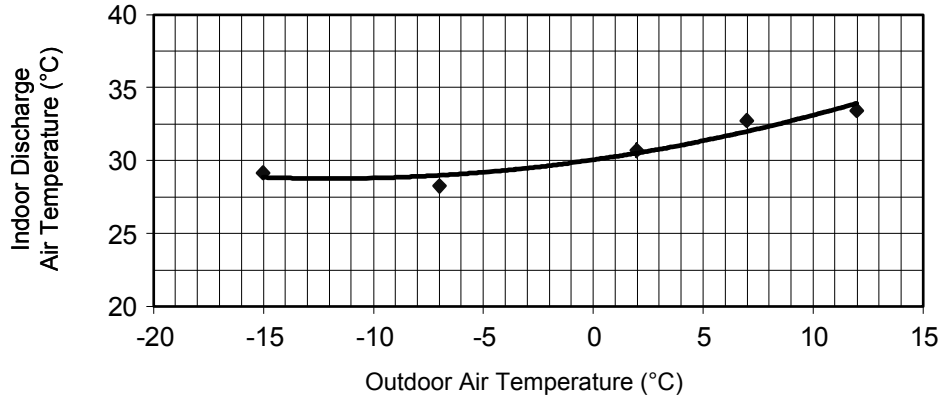

### 21.2.2 CS-RZ20WKEW CU-RZ20WKE

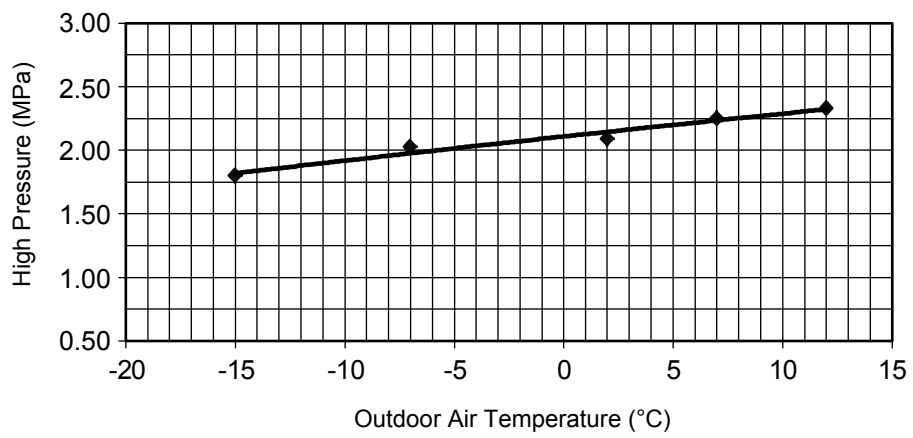
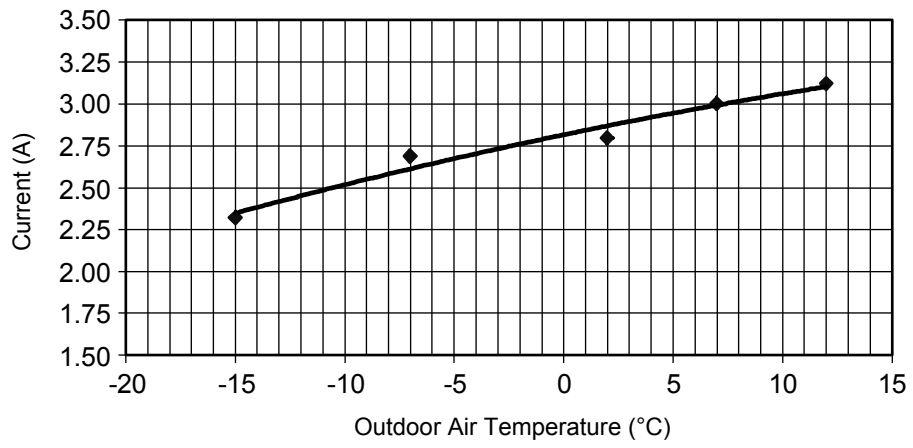
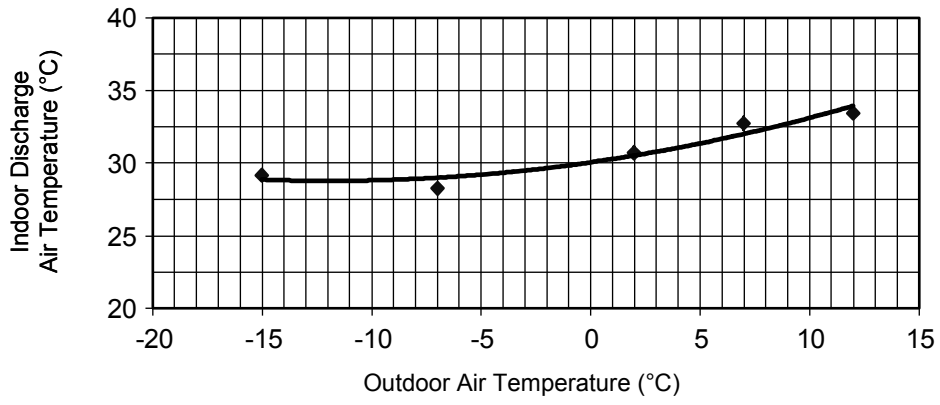

### 21.2.3 CS-TZ25WKEW CU-TZ25WKE

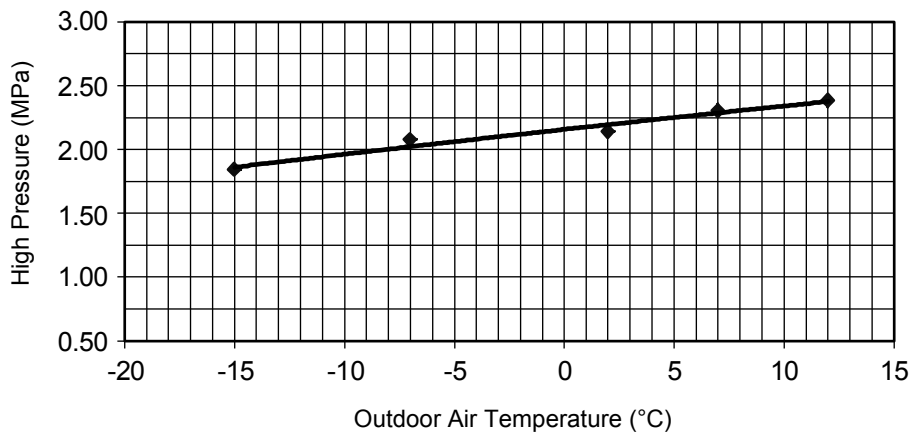
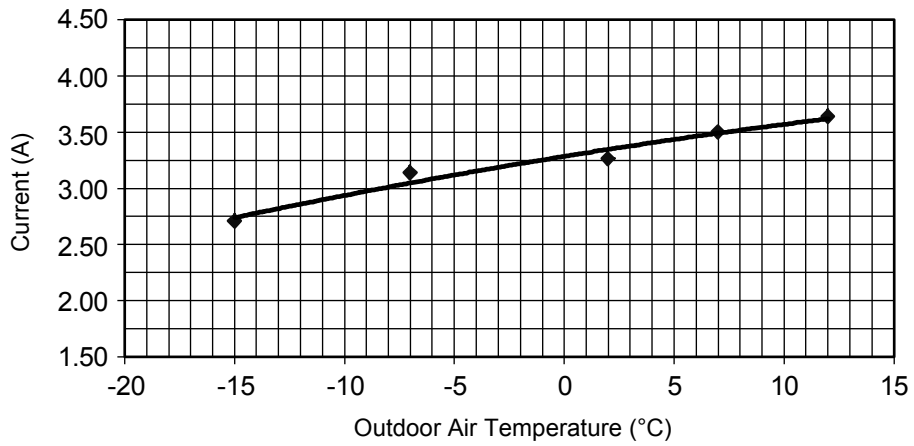
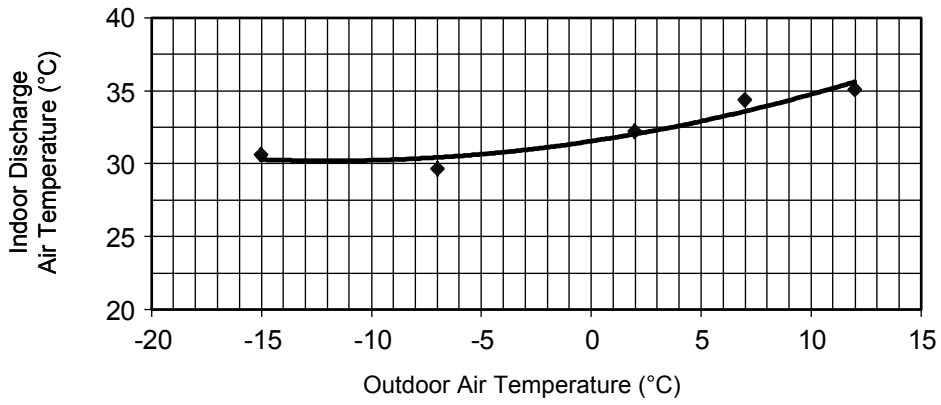

### 21.2.4 CS-RZ25WKEW CU-RZ25WKE

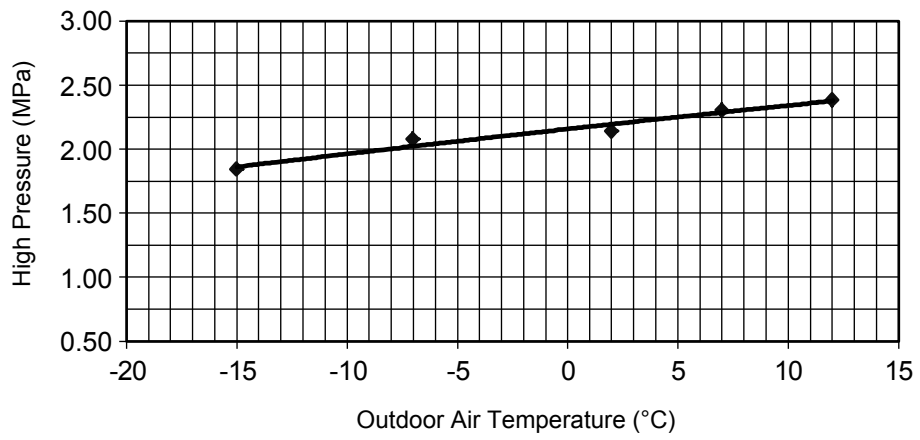
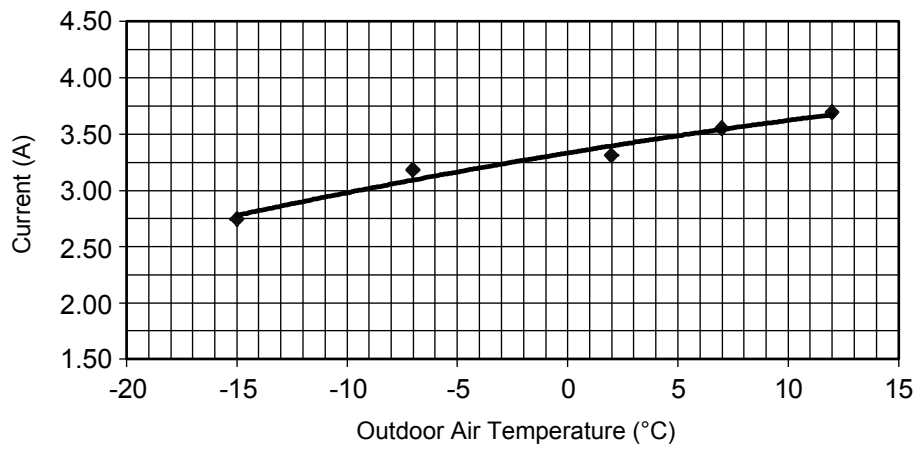
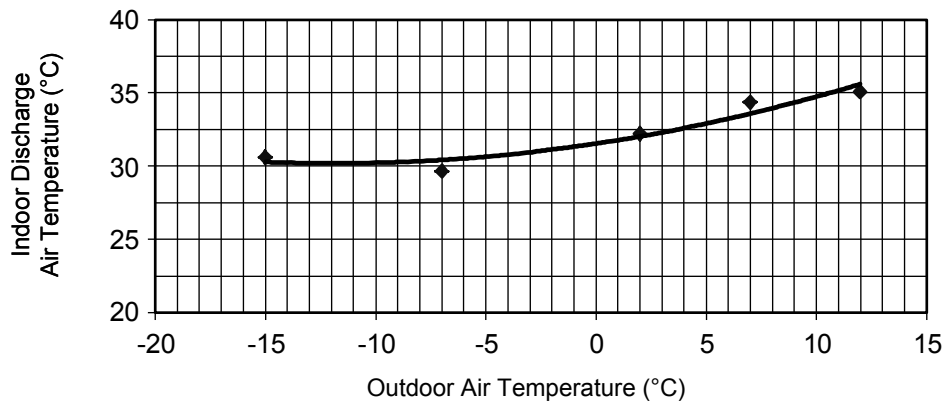

### 21.2.5 CS-TZ35WKEW CU-TZ35WKE

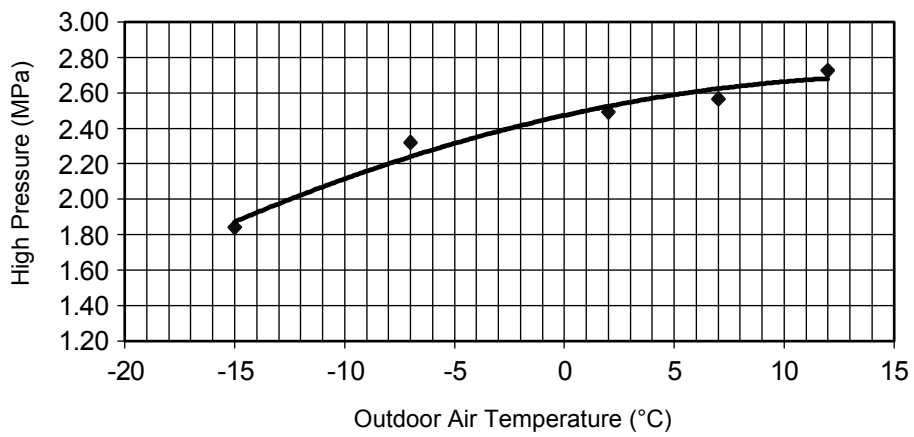
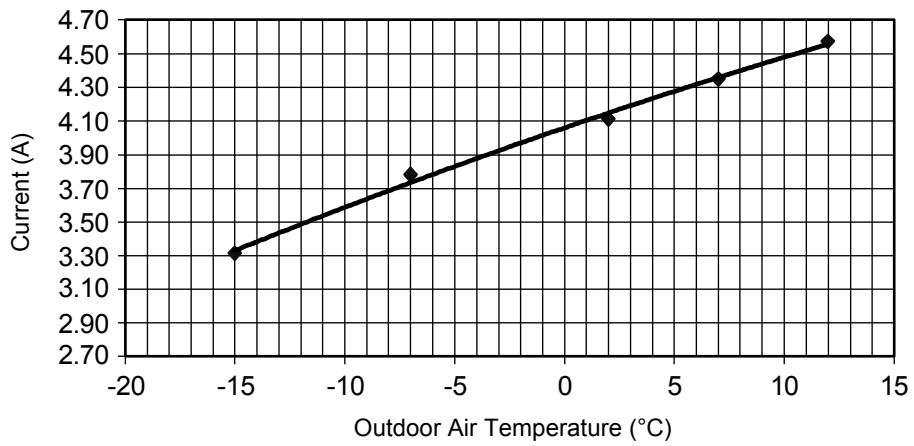
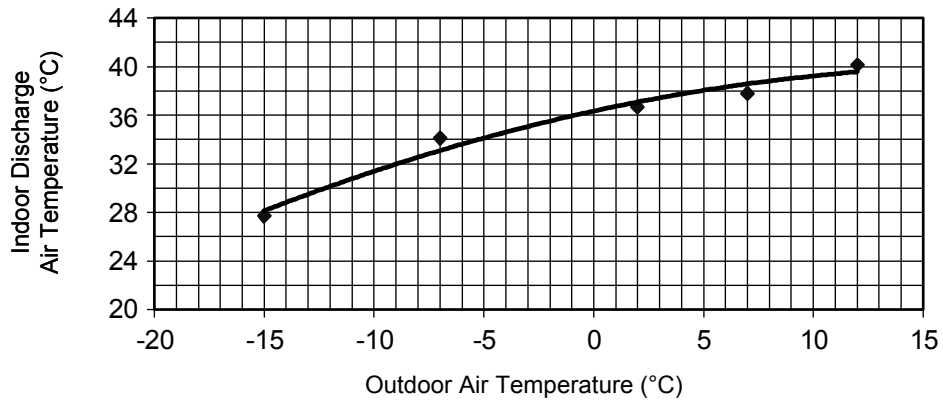

## 21.2.6 CS-RZ35WKEW CU-RZ35WKE

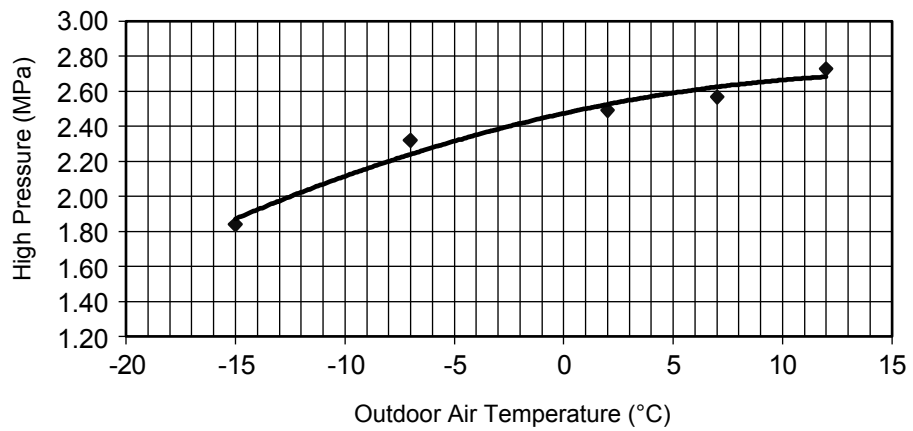
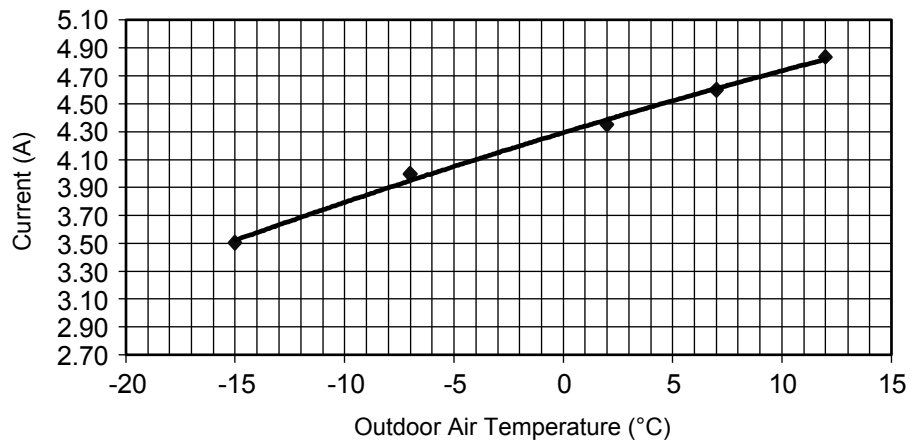
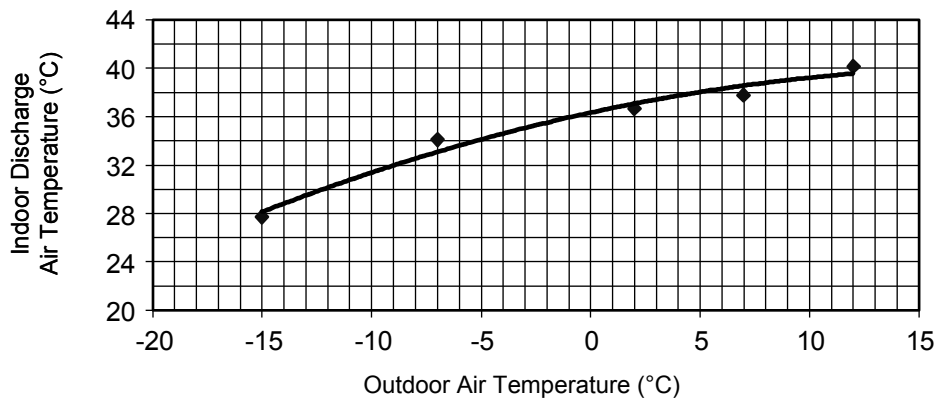

### 21.2.7 CS-TZ42WKEW CU-TZ42WKE

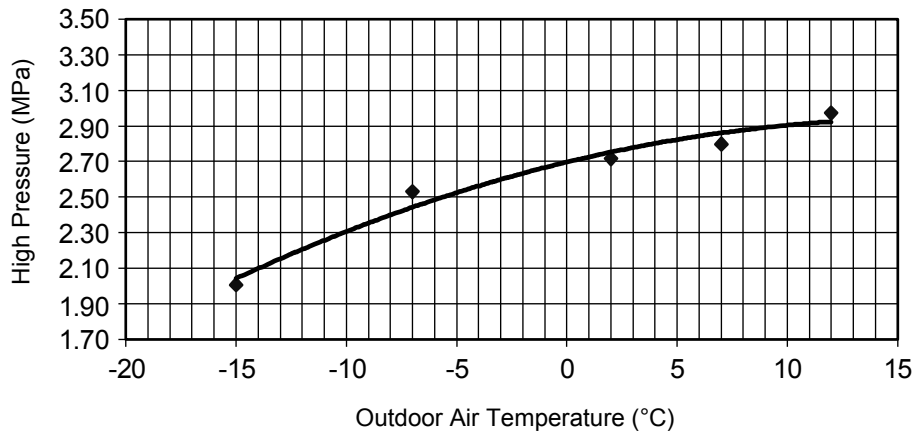
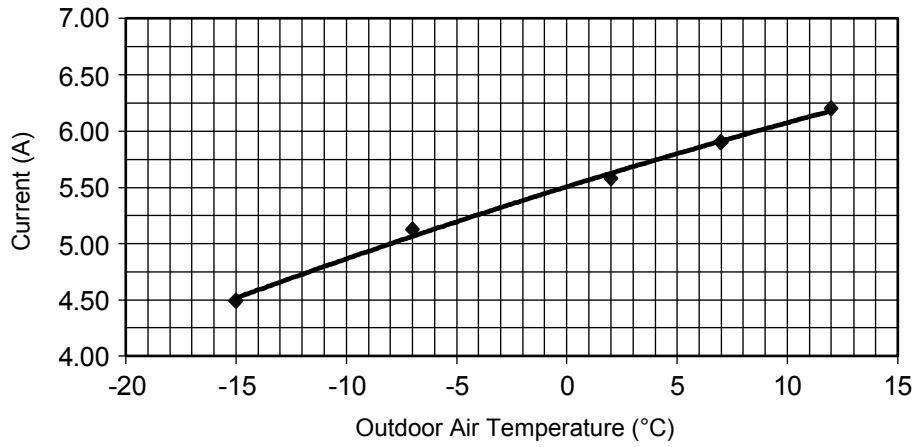
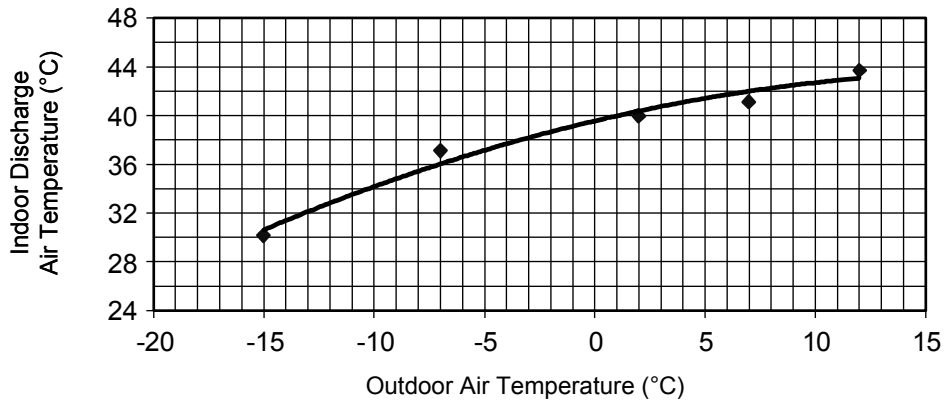

### 21.2.8 CS-TZ50WKEW CU-TZ50WKE CS-RZ50WKEW CU-RZ50WKE

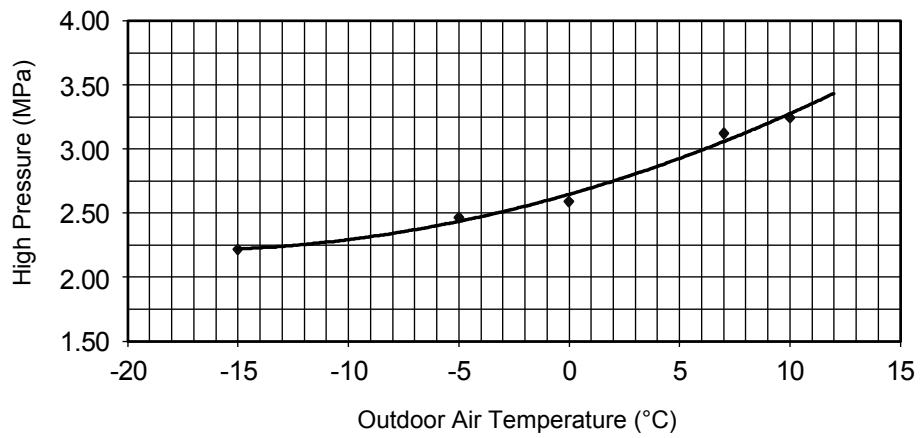
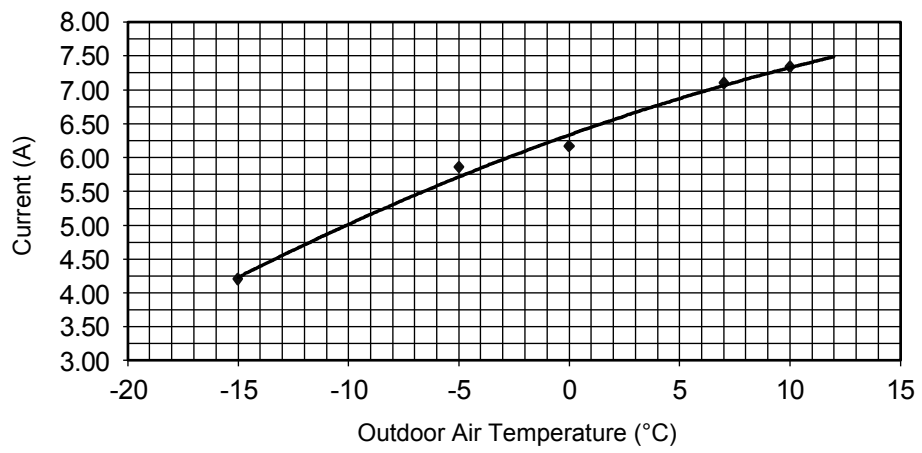
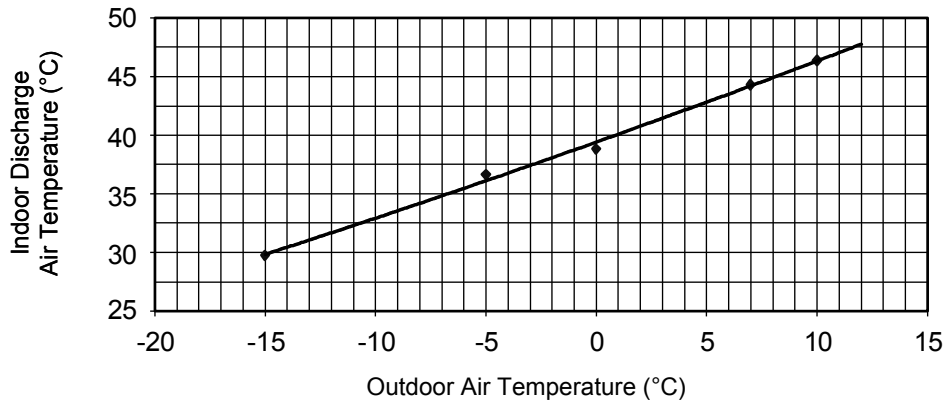

### 21.2.9 CS-TZ60WKEW CU-TZ60WKE

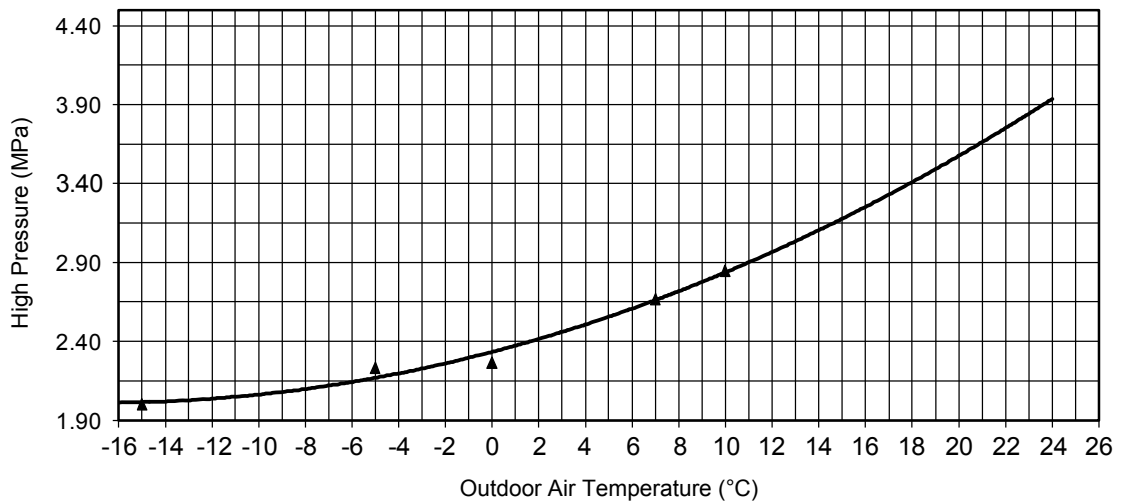
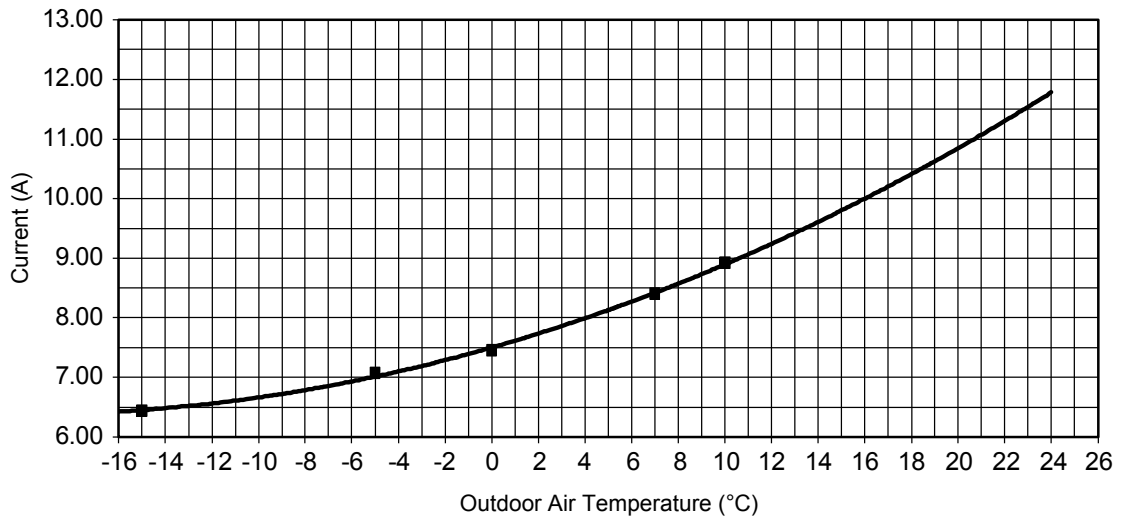
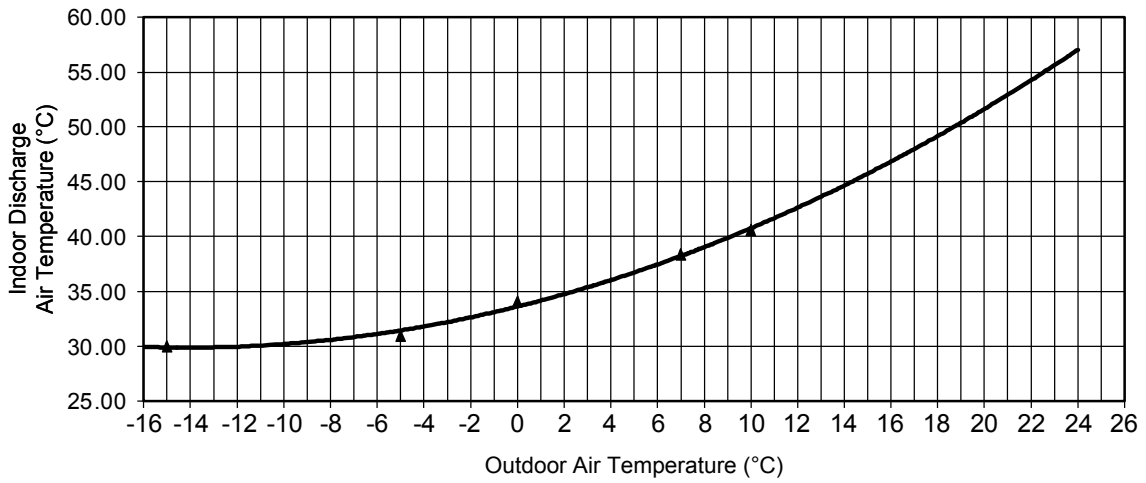

### 21.2.10 CS-TZ71WKEW CU-TZ71WKE

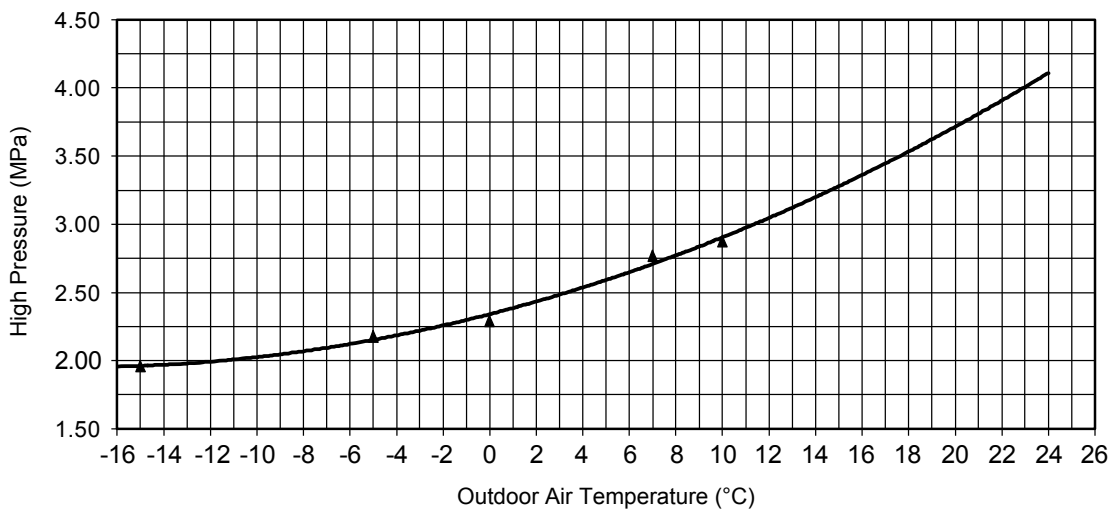
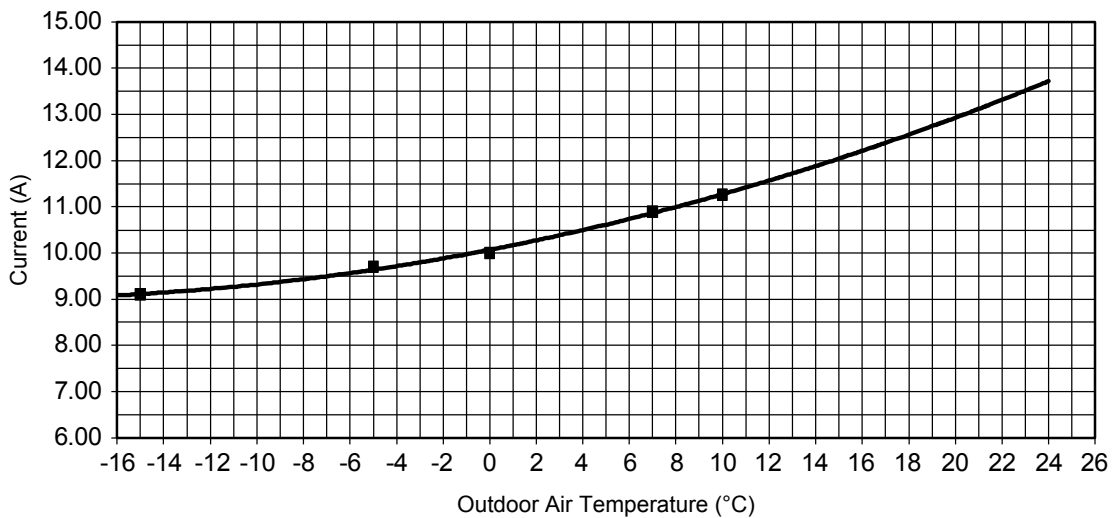
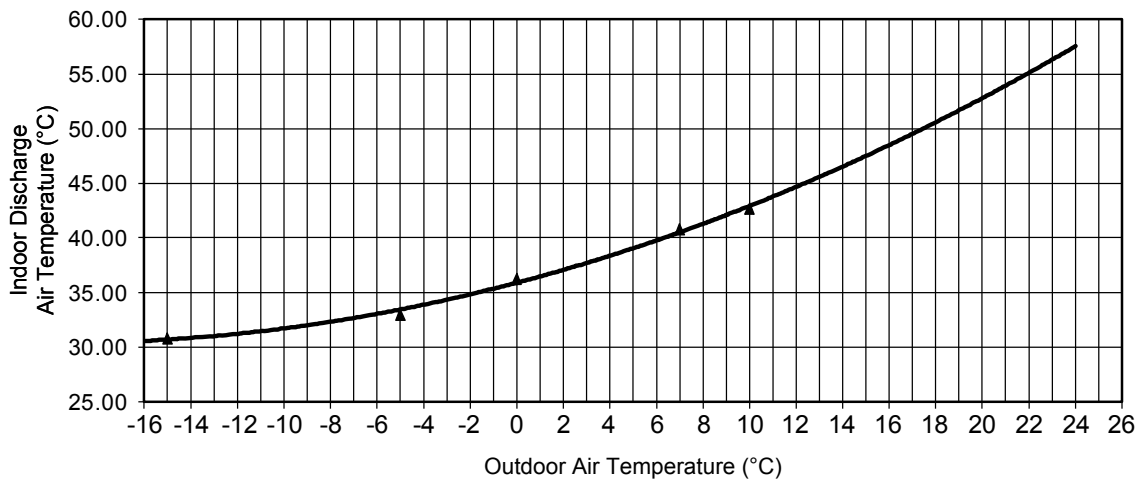

### 21.3 Piping Length Correction Factor

The characteristic of the unit has to be corrected in accordance with the piping length.

#### 21.3.1 CS-TZ20WKEW CU-TZ20WKE CS-TZ25WKEW CU-TZ25WKE CS-RZ20WKEW CU-RZ20WKE CS-RZ25WKEW CU-RZ25WKE

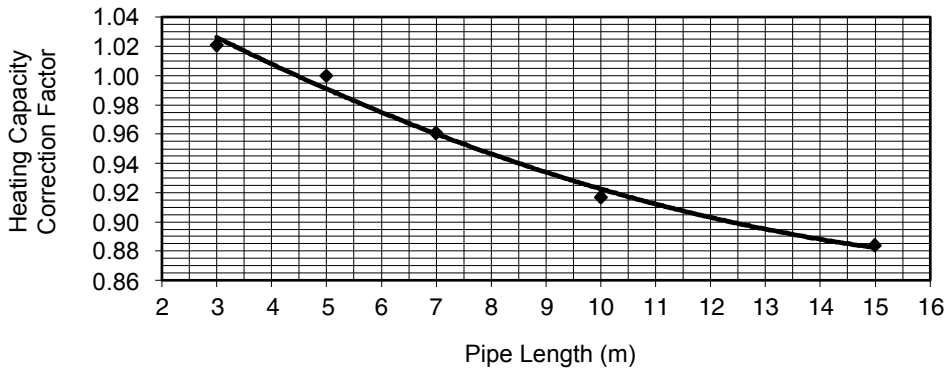
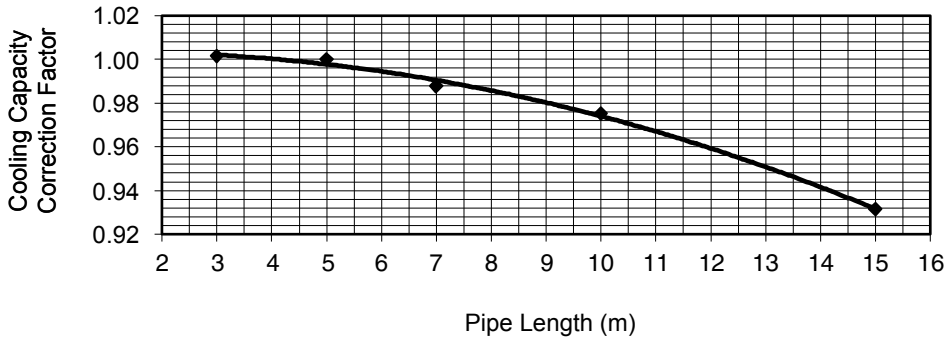

Note: The graphs show the factor after added right amount of additional refrigerant.

#### 21.3.2 CS-TZ35WKEW CU-TZ35WKE CS-RZ35WKEW CU-RZ35WKE

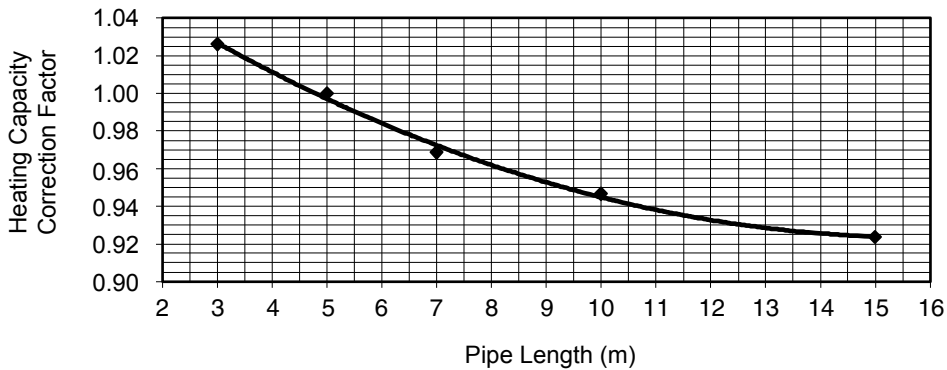
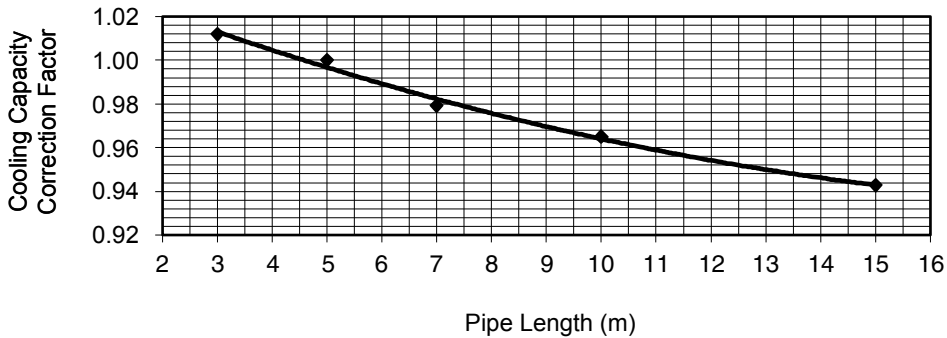

Note: The graphs show the factor after added right amount of additional refrigerant.

### 21.3.3 CS-TZ42WKEW CU-TZ42WKE

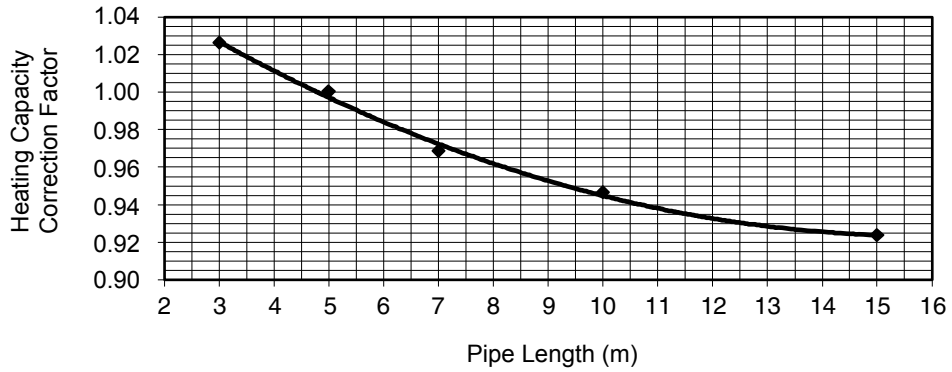
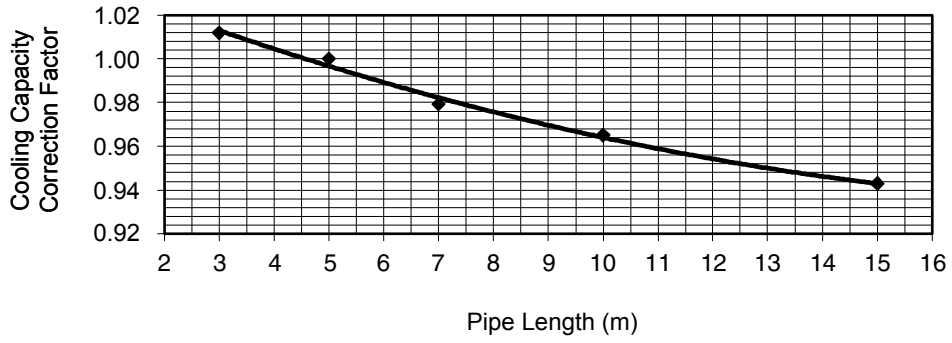

Note: The graphs show the factor after added right amount of additional refrigerant.

### 21.3.4 CS-TZ50WKEW CU-TZ50WKE CS-RZ50WKEW CU-RZ50WKE

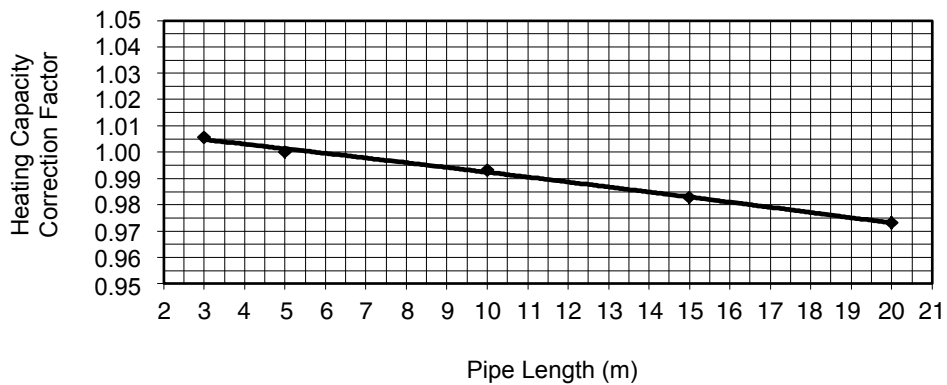
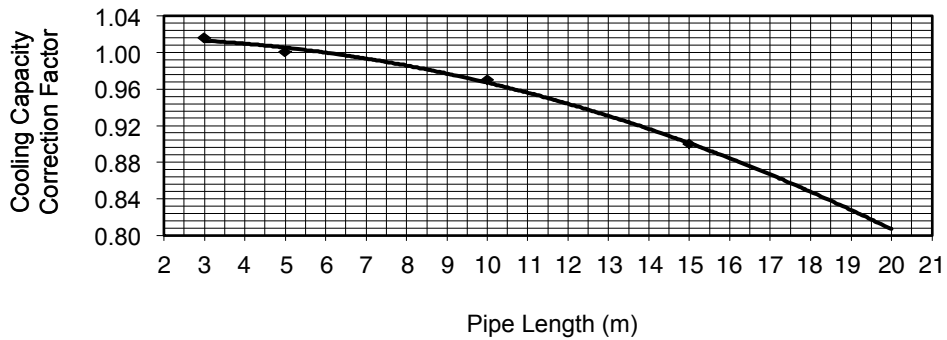

Note: The graphs show the factor after added right amount of additional refrigerant.

### 21.3.5 CS-TZ60WKEW CU-TZ60WKE

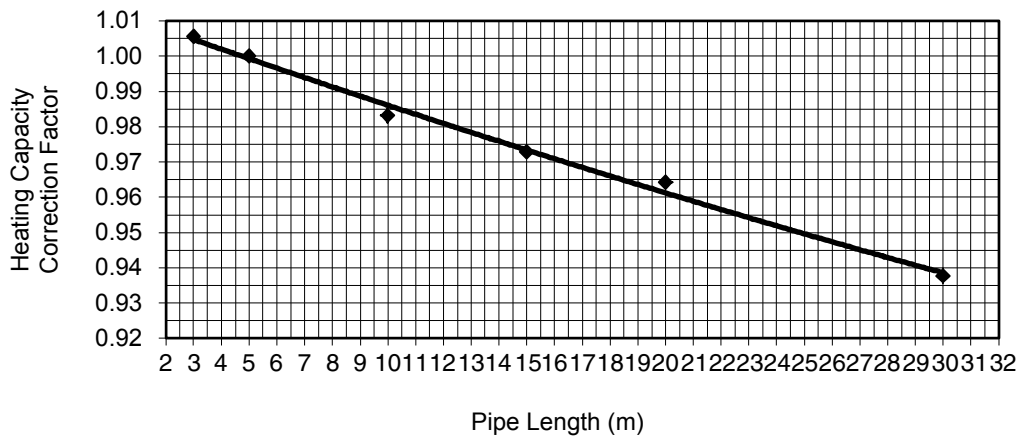
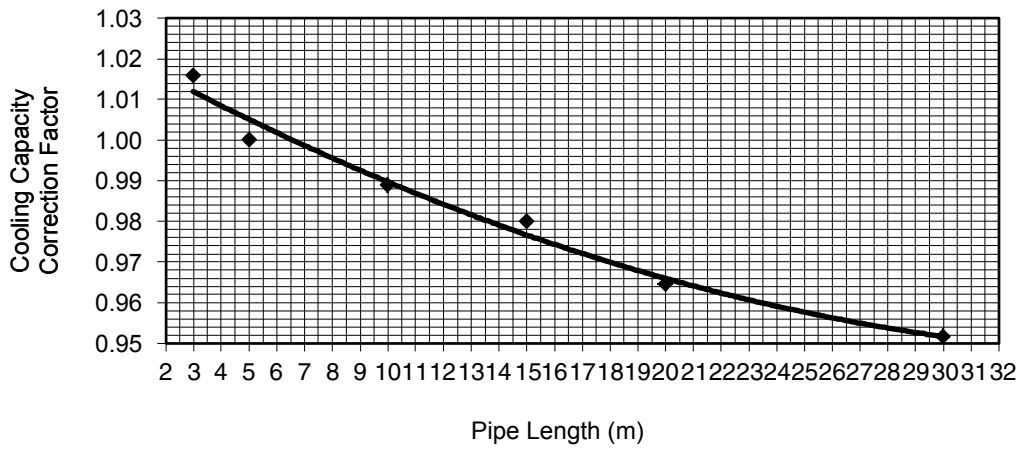

Note: The graphs show the factor after added right amount of additional refrigerant.

### 21.3.6 CS-TZ71WKEW CU-TZ71WKE

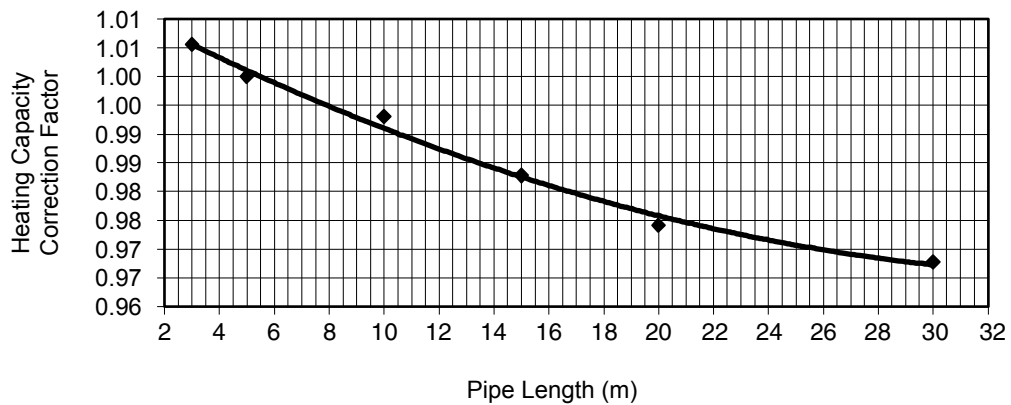
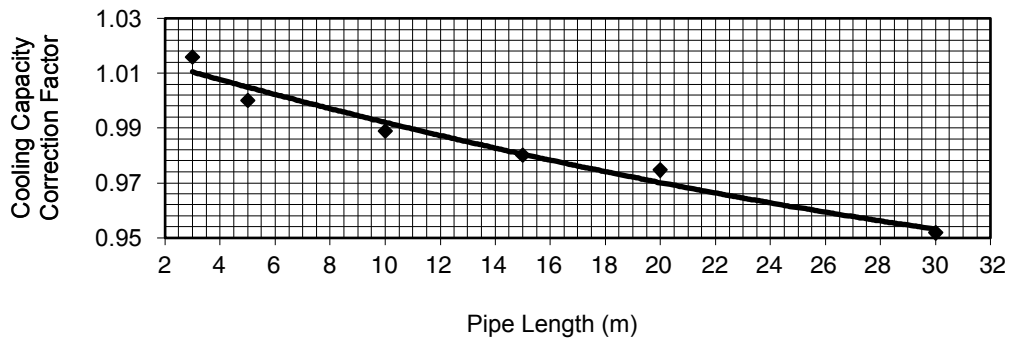

Note: The graphs show the factor after added right amount of additional refrigerant.

## 22. Exploded View and Replacement Parts List

### 22.1 Indoor Unit

#### 22.1.1 CS-TZ20WKEW CS-TZ25WKEW CS-TZ35WKEW CS-TZ42WKEW CS-TZ50WKEW CS-RZ20WKEW CS-RZ25WKEW CS-RZ35WKEW CS-RZ50WKEW

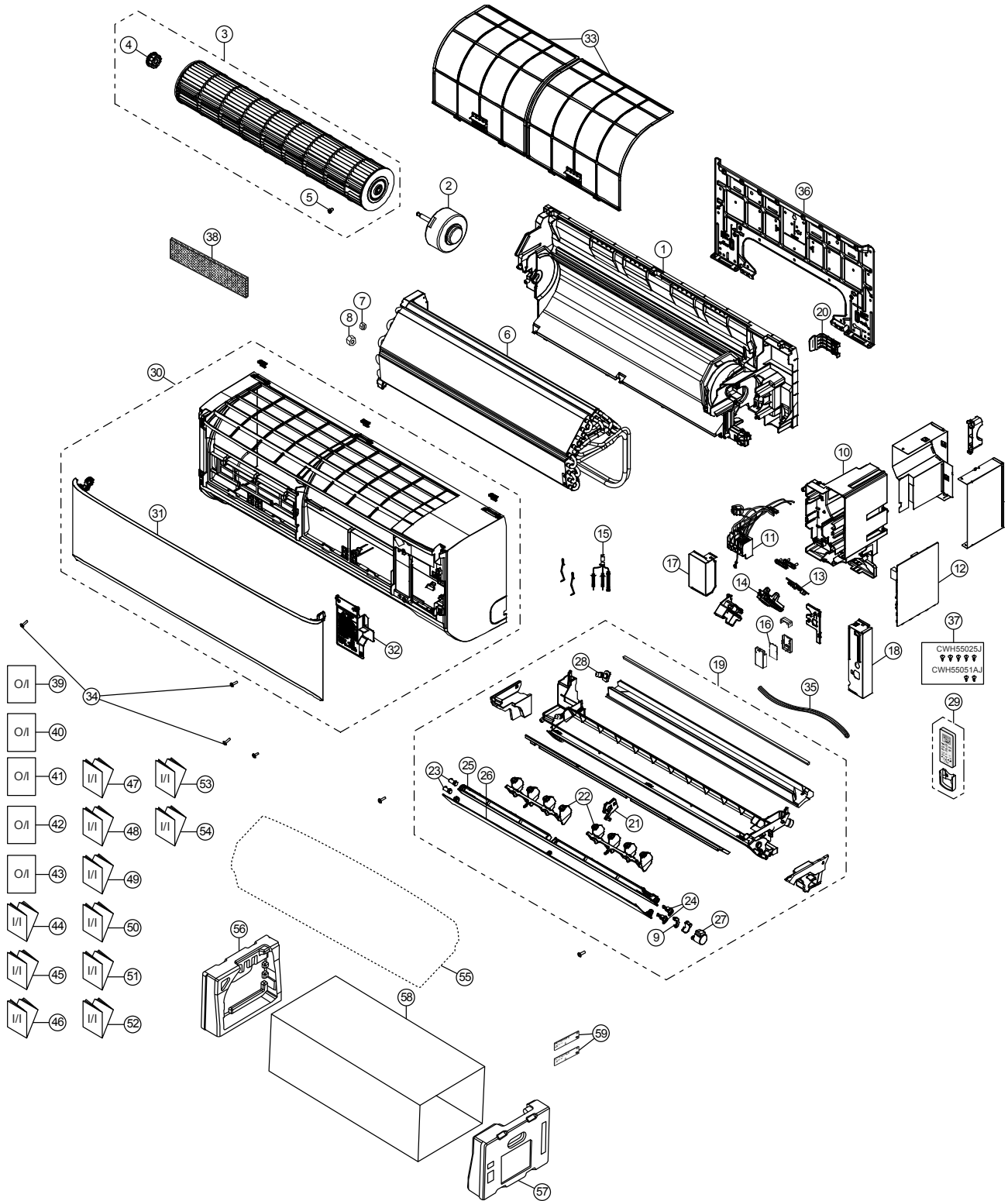

#### Note

The above exploded view is for the purpose of parts disassembly and replacement.  
The non-numbered parts are not kept as standard service parts.

SAFETY	REF. NO.	PART NAME & DESCRIPTION	QTY.	CS-TZ20WKEW	CS-TZ25WKEW	CS-TZ35WKEW	REMARK
	1	CHASSIS COMPLETE	1	ACXD50C03410	←	←	
⚠	2	FAN MOTOR	1	L6CBYYL0311	←	←	O
	3	CROSS-FLOW FAN COMPLETE	1	ACXH02C01190	←	←	
	4	BEARING ASSY	1	CWH64K1006	←	←	
	5	SCREW - CROSS-FLOW FAN	1	CWH551146	←	←	
	6	EVAPORATOR	1	ACXB30C29310	ACXB30C28590	←	
	7	FLARE NUT (LIQUID)	1	CWT251048	←	←	
	8	FLARE NUT (GAS)	1	CWT251049	←	←	
	9	LEVER ARM	1	ACXH65-00690	←	←	
	10	CONTROL BOARD CASING	1	ACXH10-07900	←	←	
⚠	11	TERMINAL BOARD COMPLETE	1	ACXA28C06010	←	←	O
⚠	12	ELECTRONIC CONTROLLER - MAIN	1	ACXA73C60160	ACXA73C60170	ACXA73C60180	O
⚠	13	ELECTRONIC CONTROLLER - INDICATOR	1	ACXA73-34540	←	←	O
	14	INDICATOR HOLDER	1	ACXD93-20780	←	←	
⚠	15	SENSOR COMPLETE	1	CWA50C2664	←	←	O
⚠	16	ELECTRONIC CONTROLLER - WIFI	1	ACXA73-28520	←	←	
	17	CONTROL BOARD COVER	1	ACXH13-08190	←	←	
	18	CONTROL BOARD COVER	1	ACXH13-08200	←	←	
	19	DISCHARGE GRILLE COMPLETE	1	ACXE20C05340	ACXE20C05330	←	
	20	BACK COVER CHASSIS	1	ACXD93-18680	←	←	
	21	FULCRUM	1	ACXH62-00680	←	←	
	22	VERTICAL VANE	2	ACXE24-03470	←	←	
	23	SHAFT	2	ACXH63-01540	←	←	
	24	SHAFT	2	ACXH63-01570	←	←	
	25	HORIZONTAL VANE - INNER	1	ACXE24-03710	←	←	
	26	HORIZONTAL VANE - OUTER	1	ACXE24-03720	←	←	
⚠	27	AIR SWING MOTOR	1	ACXA98-02000	←	←	O
	28	CAP - DRAIN TRAY	1	CWH521259	←	←	
⚠	29	REMOTE CONTROL COMPLETE	1	ACXA75C18210	←	←	O
	30	FRONT GRILLE COMPLETE	1	ACXE10C11870	←	←	O
	31	INTAKE GRILLE COMPLETE	1	ACXE22C04140	←	←	
	32	GRILLE DOOR COMPLETE	1	ACXE14C01340	←	←	
	33	AIR FILTER	2	ACXD00-02860	←	←	
	34	SCREW - FRONT GRILLE	3	XTT4+16CFJ	←	←	O
	35	DRAIN HOSE	1	ACXH85-00200	←	←	
	36	INSTALLATION PLATE	1	ACXH36-00650	←	←	
	37	BAG COMPLETE - INSTALLATION SCREW	1	CWH82C1705	←	←	
	38	AIR PURIFYING FILTER	1	CWD00C1293	←	←	O
	39	OPERATING INSTRUCTION	1	ACXF55-27150	←	←	
	40	OPERATING INSTRUCTION	1	ACXF55-27160	←	←	
	41	OPERATING INSTRUCTION	1	ACXF55-27170	←	←	
	42	OPERATING INSTRUCTION	1	ACXF55-27180	←	←	
	43	OPERATING INSTRUCTION	1	ACXF55-27190	←	←	
	44	INSTALLATION INSTRUCTION	1	ACXF60-38530	←	←	
	45	INSTALLATION INSTRUCTION	1	ACXF60-38540	←	←	
	46	INSTALLATION INSTRUCTION	1	ACXF60-38550	←	←	
	47	INSTALLATION INSTRUCTION	1	ACXF60-38560	←	←	
	48	INSTALLATION INSTRUCTION	1	ACXF60-38570	←	←	
	49	INSTALLATION INSTRUCTION	1	ACXF60-38580	←	←	
	50	INSTALLATION INSTRUCTION	1	ACXF60-38590	←	←	
	51	INSTALLATION INSTRUCTION	1	ACXF60-38600	←	←	

SAFETY	REF. NO.	PART NAME & DESCRIPTION	QTY.	CS-TZ20WKEW	CS-TZ25WKEW	CS-TZ35WKEW	REMARK
	52	INSTALLATION INSTRUCTION	1	ACXF60-38610	←	←	
	53	INSTALLATION INSTRUCTION	1	ACXF60-38620	←	←	
	54	INSTALLATION INSTRUCTION	1	ACXF60-38630	←	←	
	55	BAG	1	ACXG86-00190	←	←	
	56	SHOCK ABSORBER (L)	1	ACXG70-11650	←	←	
	57	SHOCK ABSORBER (R)	1	ACXG70-11660	←	←	
	58	C.C.CASE	1	ACXG50-54750	←	←	
	59	MODEL LABEL	2	ACXF85-34360	ACXF85-34590	ACXF85-34610	

(NOTE)

- All parts are supplied from PAPAMY, Malaysia (Vendor Code: 00029488).
- "O" marked parts are recommended to be kept in stock.

SAFETY	REF. NO.	PART NAME & DESCRIPTION	QTY.	CS-TZ42WKEW	CS-TZ50WKEW	REMARK
	1	CHASSIS COMPLETE	1	ACXD50C03410	←	
⚠	2	FAN MOTOR	1	L6CBYYL0311	←	O
	3	CROSS-FLOW FAN COMPLETE	1	ACXH02C01190	←	
	4	BEARING ASSY	1	CWH64K1006	←	
	5	SCREW - CROSS-FLOW FAN	1	CWH551146	←	
	6	EVAPORATOR	1	ACXB30C29360	←	
	7	FLARE NUT (LIQUID)	1	CWT251048	←	
	8	FLARE NUT (GAS)	1	CWT251032	←	
	9	LEVER ARM	1	ACXH65-00690	←	
	10	CONTROL BOARD CASING	1	ACXH10-07900	←	
⚠	11	TERMINAL BOARD COMPLETE	1	ACXA28C06010	ACXA28C06080	O
⚠	12	ELECTRONIC CONTROLLER - MAIN	1	ACXA73C60190	ACXA73C60200	O
⚠	13	ELECTRONIC CONTROLLER - INDICATOR	1	ACXA73-34540	←	O
	14	INDICATOR HOLDER	1	ACXD93-20780	←	
⚠	15	SENSOR COMPLETE	1	CWA50C2664	←	O
⚠	16	ELECTRONIC CONTROLLER - WIFI	1	ACXA73-28520	←	
	17	CONTROL BOARD COVER	1	ACXH13-08190	←	
	18	CONTROL BOARD COVER	1	ACXH13-08200	←	
	19	DISCHARGE GRILLE COMPLETE	1	ACXE20C05330	←	
	20	BACK COVER CHASSIS	1	ACXD93-18680	←	
	21	FULCRUM	1	ACXH62-00680	←	
	22	VERTICAL VANE	2	ACXE24-03470	←	
	23	SHAFT	2	ACXH63-01540	←	
	24	SHAFT	2	ACXH63-01570	←	
	25	HORIZONTAL VANE - INNER	1	ACXE24-03710	←	
	26	HORIZONTAL VANE - OUTER	1	ACXE24-03720	←	
⚠	27	AIR SWING MOTOR	1	ACXA98-02000	←	O
	28	CAP - DRAIN TRAY	1	CWH521259	←	
⚠	29	REMOTE CONTROL COMPLETE	1	ACXA75C18210	←	O
	30	FRONT GRILLE COMPLETE	1	ACXE10C11870	←	O
	31	INTAKE GRILLE COMPLETE	1	ACXE22C04140	←	
	32	GRILLE DOOR COMPLETE	1	ACXE14C01340	←	
	33	AIR FILTER	2	ACXD00-02860	←	
	34	SCREW - FRONT GRILLE	3	XTT4+16CFJ	←	O
	35	DRAIN HOSE	1	ACXH85-00200	←	
	36	INSTALLATION PLATE	1	ACXH36-00650	←	
	37	BAG COMPLETE - INSTALLATION SCREW	1	CWH82C1705	←	
	38	AIR PURIFYING FILTER	1	CWD00C1293	←	O
	39	OPERATING INSTRUCTION	1	ACXF55-27150	←	
	40	OPERATING INSTRUCTION	1	ACXF55-27160	←	
	41	OPERATING INSTRUCTION	1	ACXF55-27170	←	
	42	OPERATING INSTRUCTION	1	ACXF55-27180	←	
	43	OPERATING INSTRUCTION	1	ACXF55-27190	←	
	44	INSTALLATION INSTRUCTION	1	ACXF60-38530	←	
	45	INSTALLATION INSTRUCTION	1	ACXF60-38540	←	
	46	INSTALLATION INSTRUCTION	1	ACXF60-38550	←	
	47	INSTALLATION INSTRUCTION	1	ACXF60-38560	←	
	48	INSTALLATION INSTRUCTION	1	ACXF60-38570	←	
	49	INSTALLATION INSTRUCTION	1	ACXF60-38580	←	
	50	INSTALLATION INSTRUCTION	1	ACXF60-38590	←	
	51	INSTALLATION INSTRUCTION	1	ACXF60-38600	←	
	52	INSTALLATION INSTRUCTION	1	ACXF60-38610	←	

SAFETY	REF. NO.	PART NAME & DESCRIPTION	QTY.	CS-TZ42WKEW	CS-TZ50WKEW	REMARK
	53	INSTALLATION INSTRUCTION	1	ACXF60-38620	←	
	54	INSTALLATION INSTRUCTION	1	ACXF60-38630	←	
	55	BAG	1	ACXG86-00190	←	
	56	SHOCK ABSORBER (L)	1	ACXG70-11650	←	
	57	SHOCK ABSORBER (R)	1	ACXG70-11660	←	
	58	C.C.CASE	1	ACXG50-54750	←	
	59	MODEL LABEL	2	ACXF85-34700	ACXF85-34710	

(NOTE)

- All parts are supplied from PAPAMY, Malaysia (Vendor Code: 00029488).
- "O" marked parts are recommended to be kept in stock.

SAFETY	REF. NO.	PART NAME & DESCRIPTION	QTY.	CS-RZ20WKEW	CS-RZ25WKEW	REMARK
	1	CHASSIS COMPLETE	1	ACXD50C03410	←	
⚠	2	FAN MOTOR	1	L6CBYYL0311	←	O
	3	CROSS-FLOW FAN COMPLETE	1	ACXH02C01190	←	
	4	BEARING ASSY	1	CWH64K1006	←	
	5	SCREW - CROSS-FLOW FAN	1	CWH551146	←	
	6	EVAPORATOR	1	ACXB30C29310	ACXB30C28590	
	7	FLARE NUT (LIQUID)	1	CWT251048	←	
	8	FLARE NUT (GAS)	1	CWT251049	←	
	9	LEVER ARM	1	ACXH65-00690	←	
	10	CONTROL BOARD CASING	1	ACXH10-07900	←	
⚠	11	TERMINAL BOARD COMPLETE	1	ACXA28C06010	←	O
⚠	12	ELECTRONIC CONTROLLER - MAIN	1	ACXA73C60210	ACXA73C60220	O
⚠	13	ELECTRONIC CONTROLLER - INDICATOR	1	ACXA73-34540	←	O
	14	INDICATOR HOLDER	1	ACXD93-20780	←	
⚠	15	SENSOR COMPLETE	1	CWA50C2664	←	O
⚠	16	ELECTRONIC CONTROLLER - WIFI	1	ACXA73-28520	←	
	17	CONTROL BOARD COVER	1	ACXH13-08190	←	
	18	CONTROL BOARD COVER	1	ACXH13-08200	←	
	19	DISCHARGE GRILLE COMPLETE	1	ACXE20C05340	ACXE20C05330	
	20	BACK COVER CHASSIS	1	ACXD93-18680	←	
	21	FULCRUM	1	ACXH62-00680	←	
	22	VERTICAL VANE	2	ACXE24-03470	←	
	23	SHAFT	2	ACXH63-01540	←	
	24	SHAFT	2	ACXH63-01570	←	
	25	HORIZONTAL VANE - INNER	1	ACXE24-03710	←	
	26	HORIZONTAL VANE - OUTER	1	ACXE24-03720	←	
⚠	27	AIR SWING MOTOR	1	ACXA98-02000	←	O
	28	CAP - DRAIN TRAY	1	CWH521259	←	
⚠	29	REMOTE CONTROL COMPLETE	1	ACXA75C18210	←	O
	30	FRONT GRILLE COMPLETE	1	ACXE10C12060	←	O
	31	INTAKE GRILLE COMPLETE	1	ACXE22C04140	←	
	32	GRILLE DOOR COMPLETE	1	ACXE14C01340	←	
	33	AIR FILTER	2	ACXD00-02860	←	
	34	SCREW - FRONT GRILLE	3	XTT4+16CFJ	←	O
	35	DRAIN HOSE	1	ACXH85-00200	←	
	36	INSTALLATION PLATE	1	ACXH36-00650	←	
	37	BAG COMPLETE - INSTALLATION SCREW	1	CWH82C1705	←	
	38	AIR PURIFYING FILTER	1	CWD00C1291	←	O
	39	OPERATING INSTRUCTION	1	ACXF55-27150	←	
	40	OPERATING INSTRUCTION	1	ACXF55-27160	←	
	41	OPERATING INSTRUCTION	1	ACXF55-27170	←	
	42	OPERATING INSTRUCTION	1	ACXF55-27180	←	
	43	OPERATING INSTRUCTION	1	ACXF55-27190	←	
	44	INSTALLATION INSTRUCTION	1	ACXF60-38530	←	
	45	INSTALLATION INSTRUCTION	1	ACXF60-38540	←	
	46	INSTALLATION INSTRUCTION	1	ACXF60-38550	←	
	47	INSTALLATION INSTRUCTION	1	ACXF60-38560	←	
	48	INSTALLATION INSTRUCTION	1	ACXF60-38570	←	
	49	INSTALLATION INSTRUCTION	1	ACXF60-38580	←	
	50	INSTALLATION INSTRUCTION	1	ACXF60-38590	←	
	51	INSTALLATION INSTRUCTION	1	ACXF60-38600	←	
	52	INSTALLATION INSTRUCTION	1	ACXF60-38610	←	

SAFETY	REF. NO.	PART NAME & DESCRIPTION	QTY.	CS-RZ20WKEW	CS-RZ25WKEW	REMARK
	53	INSTALLATION INSTRUCTION	1	ACXF60-38620	←	
	54	INSTALLATION INSTRUCTION	1	ACXF60-38630	←	
	55	BAG	1	ACXG86-00190	←	
	56	SHOCK ABSORBER (L)	1	ACXG70-11650	←	
	57	SHOCK ABSORBER (R)	1	ACXG70-11660	←	
	58	C.C.CASE	1	ACXG50-54750	←	
	59	MODEL LABEL	2	ACXF85-34370	ACXF85-34600	

(NOTE)

- All parts are supplied from PAPAMY, Malaysia (Vendor Code: 00029488).
- "O" marked parts are recommended to be kept in stock.

SAFETY	REF. NO.	PART NAME & DESCRIPTION	QTY.	CS-RZ35WKEW	CS-RZ50WKEW	REMARK
	1	CHASSIS COMPLETE	1	ACXD50C03410	←	
⚠	2	FAN MOTOR	1	L6CBYYL0311	←	O
	3	CROSS-FLOW FAN COMPLETE	1	ACXH02C01190	←	
	4	BEARING ASSY	1	CWH64K1006	←	
	5	SCREW - CROSS-FLOW FAN	1	CWH551146	←	
	6	EVAPORATOR	1	ACXB30C28590	ACXB30C29360	
	7	FLARE NUT (LIQUID)	1	CWT251048	←	
	8	FLARE NUT (GAS)	1	CWT251049	CWT251032	
	9	LEVER ARM	1	ACXH65-00690	←	
	10	CONTROL BOARD CASING	1	ACXH10-07900	←	
⚠	11	TERMINAL BOARD COMPLETE	1	ACXA28C06010	ACXA28C06080	O
⚠	12	ELECTRONIC CONTROLLER - MAIN	1	ACXA73C60230	ACXA73C60200	O
⚠	13	ELECTRONIC CONTROLLER - INDICATOR	1	ACXA73-34540	←	O
	14	INDICATOR HOLDER	1	ACXD93-20780	←	
⚠	15	SENSOR COMPLETE	1	CWA50C2664	←	O
⚠	16	ELECTRONIC CONTROLLER - WIFI	1	ACXA73-28520	←	
	17	CONTROL BOARD COVER	1	ACXH13-08190	←	
	18	CONTROL BOARD COVER	1	ACXH13-08200	←	
	19	DISCHARGE GRILLE COMPLETE	1	ACXE20C05330	←	
	20	BACK COVER CHASSIS	1	ACXD93-18680	←	
	21	FULCRUM	1	ACXH62-00680	←	
	22	VERTICAL VANE	2	ACXE24-03470	←	
	23	SHAFT	2	ACXH63-01540	←	
	24	SHAFT	2	ACXH63-01570	←	
	25	HORIZONTAL VANE - INNER	1	ACXE24-03710	←	
	26	HORIZONTAL VANE - OUTER	1	ACXE24-03720	←	
⚠	27	AIR SWING MOTOR	1	ACXA98-02000	←	O
	28	CAP - DRAIN TRAY	1	CWH521259	←	
⚠	29	REMOTE CONTROL COMPLETE	1	ACXA75C18210	←	O
	30	FRONT GRILLE COMPLETE	1	ACXE10C12060	←	O
	31	INTAKE GRILLE COMPLETE	1	ACXE22C04140	←	
	32	GRILLE DOOR COMPLETE	1	ACXE14C01340	←	
	33	AIR FILTER	2	ACXD00-02860	←	
	34	SCREW - FRONT GRILLE	3	XTT4+16CFJ	←	O
	35	DRAIN HOSE	1	ACXH85-00200	←	
	36	INSTALLATION PLATE	1	ACXH36-00650	←	
	37	BAG COMPLETE - INSTALLATION SCREW	1	CWH82C1705	←	
	38	AIR PURIFYING FILTER	1	CWD00C1291	←	O
	39	OPERATING INSTRUCTION	1	ACXF55-27150	←	
	40	OPERATING INSTRUCTION	1	ACXF55-27160	←	
	41	OPERATING INSTRUCTION	1	ACXF55-27170	←	
	42	OPERATING INSTRUCTION	1	ACXF55-27180	←	
	43	OPERATING INSTRUCTION	1	ACXF55-27190	←	
	44	INSTALLATION INSTRUCTION	1	ACXF60-38530	←	
	45	INSTALLATION INSTRUCTION	1	ACXF60-38540	←	
	46	INSTALLATION INSTRUCTION	1	ACXF60-38550	←	
	47	INSTALLATION INSTRUCTION	1	ACXF60-38560	←	
	48	INSTALLATION INSTRUCTION	1	ACXF60-38570	←	
	49	INSTALLATION INSTRUCTION	1	ACXF60-38580	←	
	50	INSTALLATION INSTRUCTION	1	ACXF60-38590	←	
	51	INSTALLATION INSTRUCTION	1	ACXF60-38600	←	
	52	INSTALLATION INSTRUCTION	1	ACXF60-38610	←	

SAFETY	REF. NO.	PART NAME & DESCRIPTION	QTY.	CS-RZ35WKEW	CS-RZ50WKEW	REMARK
	53	INSTALLATION INSTRUCTION	1	ACXF60-38620	←	
	54	INSTALLATION INSTRUCTION	1	ACXF60-38630	←	
	55	BAG	1	ACXG86-00190	←	
	56	SHOCK ABSORBER (L)	1	ACXG70-11650	←	
	57	SHOCK ABSORBER (R)	1	ACXG70-11660	←	
	58	C.C.CASE	1	ACXG50-54750	←	
	59	MODEL LABEL	2	ACXF85-34620	ACXF85-34720	

(NOTE)

- All parts are supplied from PAPAMY, Malaysia (Vendor Code: 00029488).
- "O" marked parts are recommended to be kept in stock.

## 22.1.2 CS-TZ60WKEW CS-TZ71WKEW

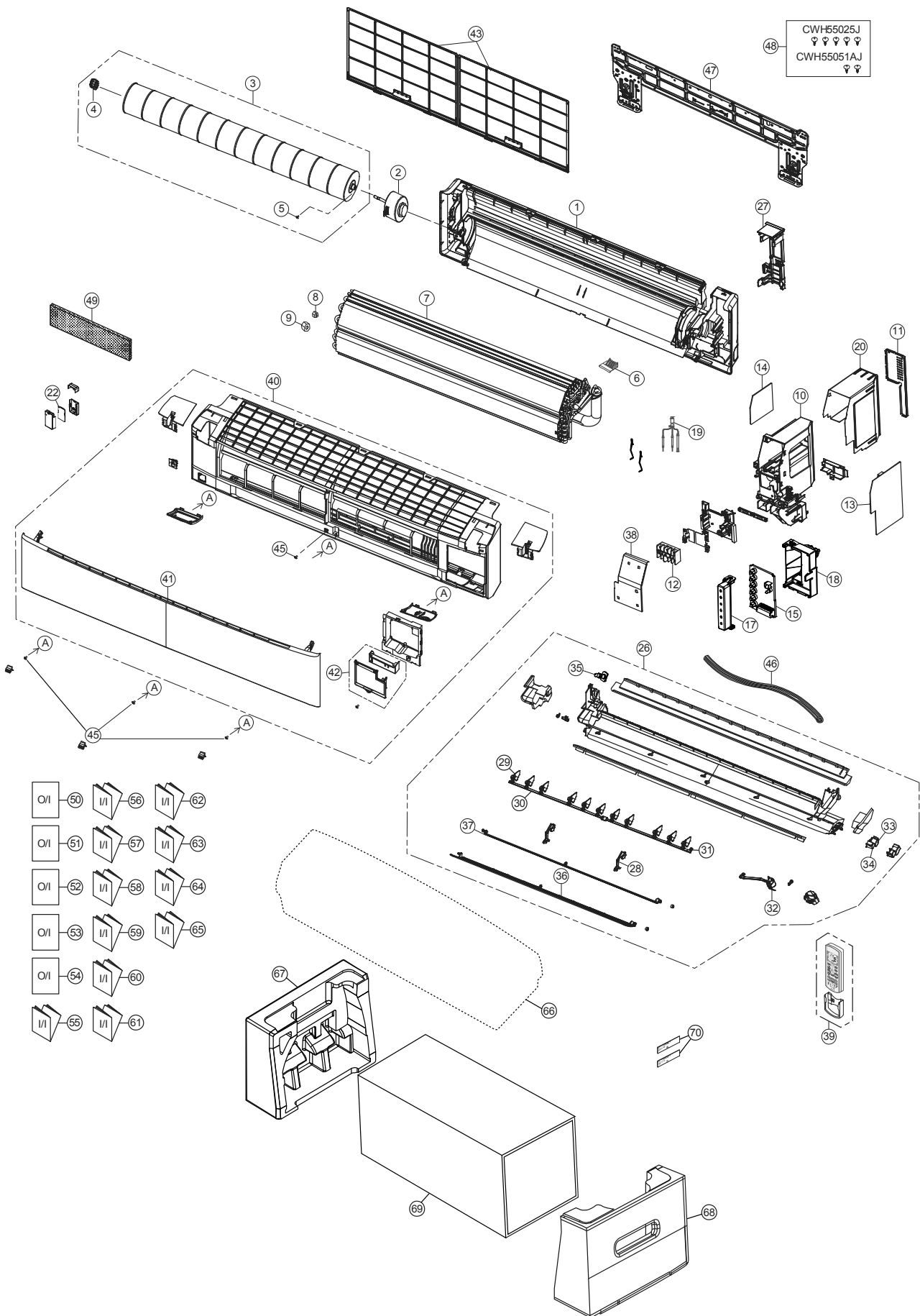

**Note**  
 The above exploded view is for the purpose of parts disassembly and replacement.  
 The non-numbered parts are not kept as standard service parts.

SAFETY	REF. NO.	PART NAME & DESCRIPTION	QTY.	CS-TZ60WKEW	CS-TZ71WKEW	REMARK
	1	CHASSIS COMPLETE	1	ACXD50C01591	←	
⚠	2	FAN MOTOR	1	L6CBYYL0193	L6CBYYL0194	O
	3	CROSS-FLOW FAN COMPLETE	1	CWH02C1136	←	
	4	BEARING ASSY	1	CWH64K1010	←	
	5	SCREW - CROSS-FLOW FAN	1	CWH551146	←	
	6	PARTICULAR PIECE	1	CWD933067B	←	
	7	EVAPORATOR	1	ACXB30C24650	ACXB30C24560	
	8	FLARE NUT (LIQUID)	1	CWT251030	←	
	9	FLARE NUT (GAS)	1	CWT251032	CWT251033	
	10	CONTROL BOARD CASING	1	ACXH10-00720	←	
	11	CONTROL BOARD COVER	1	ACXH13-00440	←	
⚠	12	TERMINAL BOARD COMPLETE	1	ACXA28C05590	←	O
⚠	13	ELECTRONIC CONTROLLER - MAIN	1	ACXA73C61940	ACXA73C61950	O
⚠	14	ELECTRONIC CONTROLLER - SUB	1	ACXA73-34240	←	
⚠	15	ELECTRONIC CONTROLLER - INDICATOR	1	ACXA73-34260	←	O
	17	INDICATOR HOLDER	1	ACXD93-01960	←	
	18	INDICATOR HOLDER	1	ACXD93-01970	←	
⚠	19	SENSOR COMPLETE	1	CWA50C3226	CWA50C2664	O
	20	CONTROL BOARD COVER	1	ACXH13-00430	←	
⚠	22	ELECTRONIC CONTROLLER - WIFI	1	ACXA73-28520	←	
	26	DISCHARGE GRILLE COMPLETE	1	ACXE20C00490	←	
	27	BACK COVER CHASSIS	1	ACXD93-10180	←	
	28	FULCRUM	2	ACXH62-00080	←	
	29	VERTICAL VANE	11	ACXE24-00400	←	
	30	CONNECTING BAR	1	ACXE26-00190	←	
	31	CONNECTING BAR	1	ACXE26-00200	←	
⚠	32	AIR SWING MOTOR ASSY	1	ACXA98K00030	←	O
⚠	33	AIR SWING MOTOR (BIG)	1	ACXA98-02000	←	O
⚠	34	AIR SWING MOTOR (SMALL)	1	ACXA98-01990	←	O
	35	CAP - DRAIN TRAY	1	CWH521259	←	
	36	HORIZONTAL VANE COMPLETE (BIG)	1	ACXE24C00551	←	
	37	HORIZONTAL VANE COMPLETE (SMALL)	1	ACXE24C00540	←	
	38	CONTROL BOARD TOP COVER	1	ACXH13C00150	←	
⚠	39	REMOTE CONTROL COMPLETE	1	ACXA75C18230	←	O
	40	FRONT GRILLE COMPLETE	1	ACXE10C11860	←	O
	41	INTAKE GRILLE COMPLETE	1	ACXE22K01090	←	
	42	GRILLE DOOR COMPLETE	1	ACXE14C00050	←	
	43	AIR FILTER	2	ACXD00-00250	←	O
	45	SCREW - FRONT GRILLE	4	XTT4+16CFJ	←	
	46	DRAIN HOSE	1	ACXH85-00210	←	
	47	INSTALLATION PLATE	1	ACXH36-00080	←	
	48	BAG COMPLETE - INSTALLATION SCREW	1	CWH82C1705	←	
	49	AIR PURIFYING FILTER	1	CWD00C1293	←	
	50	OPERATING INSTRUCTION	1	ACXF55-27150	←	
	51	OPERATING INSTRUCTION	1	ACXF55-27160	←	
	52	OPERATING INSTRUCTION	1	ACXF55-27170	←	
	53	OPERATING INSTRUCTION	1	ACXF55-27180	←	
	54	OPERATING INSTRUCTION	1	ACXF55-27190	←	
	55	INSTALLATION INSTRUCTION	1	ACXF60-38530	←	
	56	INSTALLATION INSTRUCTION	1	ACXF60-38540	←	

SAFETY	REF. NO.	PART NAME & DESCRIPTION	QTY.	CS-TZ60WKEW	CS-TZ71WKEW	REMARK
	57	INSTALLATION INSTRUCTION	1	ACXF60-38550	←	
	58	INSTALLATION INSTRUCTION	1	ACXF60-38560	←	
	59	INSTALLATION INSTRUCTION	1	ACXF60-38570	←	
	60	INSTALLATION INSTRUCTION	1	ACXF60-38580	←	
	61	INSTALLATION INSTRUCTION	1	ACXF60-38590	←	
	62	INSTALLATION INSTRUCTION	1	ACXF60-38600	←	
	63	INSTALLATION INSTRUCTION	1	ACXF60-38610	←	
	64	INSTALLATION INSTRUCTION	1	ACXF60-38620	←	
	65	INSTALLATION INSTRUCTION	1	ACXF60-38630	←	
	66	BAG	1	ACXG86-00130	←	
	67	SHOCK ABSORBER (L)	1	ACXG70-01230	←	
	68	SHOCK ABSORBER (R)	1	ACXG70-01220	←	
	69	C. C. CASE	1	ACXG50-49081	←	
	70	MODEL LABEL	2	ACXF85-34340	ACXF85-34350	

(NOTE)

- All parts are supplied from PAPAMY, Malaysia (Vendor Code: 00029488).
- "O" marked parts are recommended to be kept in stock.

## 22.2 Outdoor Unit

### 22.2.1 CU-TZ20WKE CU-TZ25WKE CU-TZ35WKE CU-TZ42WKE CU-RZ20WKE CU-RZ25WKE CU-RZ35WKE

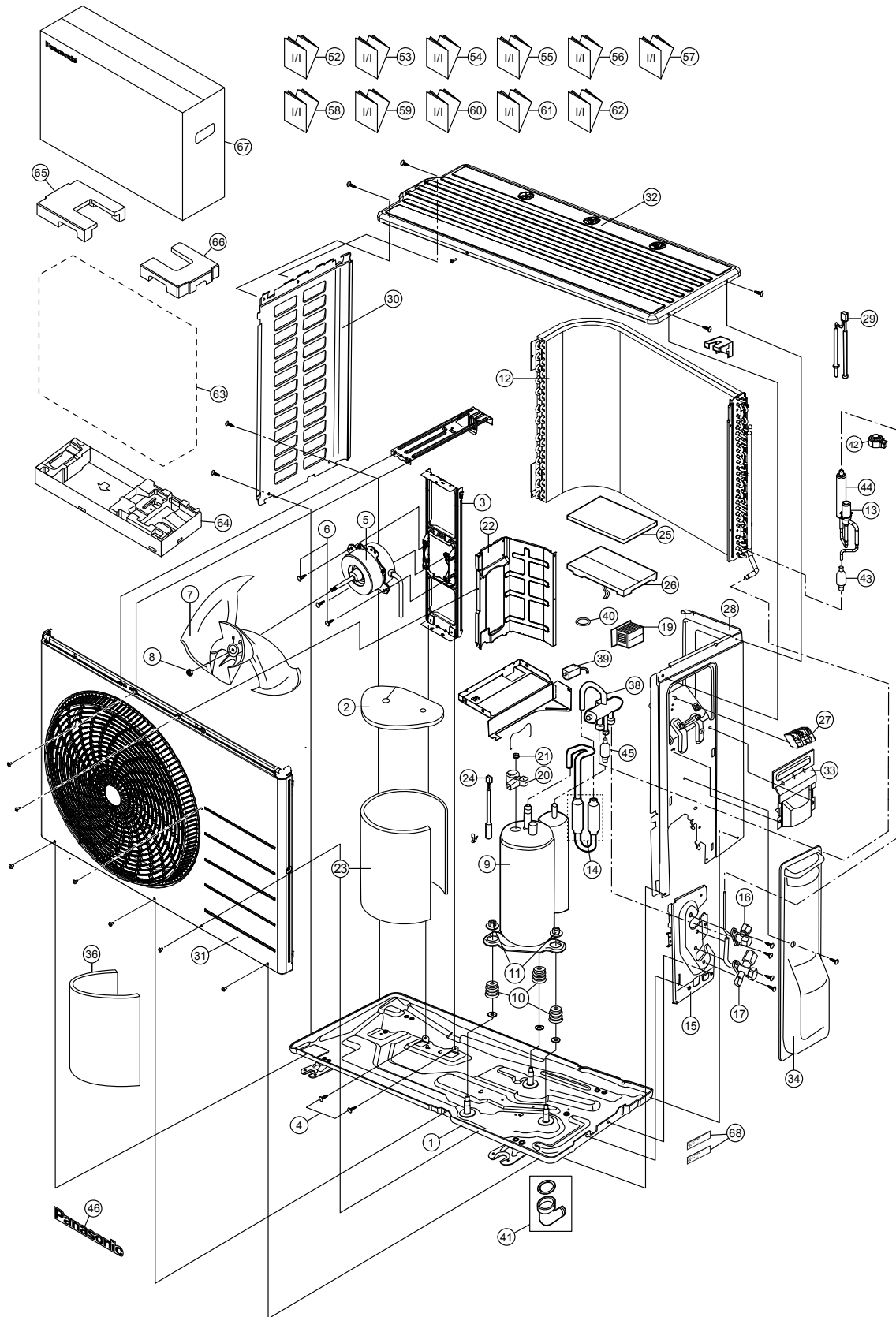

Note  
The above exploded view is for the purpose of parts disassembly and replacement.  
The non-numbered parts are not kept as standard service parts.

SAFETY	REF. NO.	PART NAME & DESCRIPTION	QTY.	CU-TZ20WKE	CU-TZ25WKE	REMARK
	1	CHASSIS COMPLETE	1	ACXD52K00150	←	
	2	SOUND PROOF MATERIAL (TOP)	1	CWG302737	←	
	3	FAN MOTOR BRACKET	1	CWD541157	←	
	4	SCREW - FAN MOTOR BRACKET	2	CWH551217	←	
⚠	5	FAN MOTOR	1	L6CAYYYL0124	←	O
	6	SCREW - FAN MOTOR MOUNT	4	CWH55252J	←	
	7	PROPELLER FAN ASSY	1	CWH03K1100	←	
	8	NUT - PROPELLER FAN	1	CWH56053J	←	
⚠	9	COMPRESSOR	1	9GS064XAA21	9GS075XAA21	O
	10	ANTI - VIBRATION BUSHING	3	CWH501038	←	
	11	NUT - COMPRESSOR MOUNT	3	CWH561096	←	
	12	CONDENSER	1	ACXB32C14790	ACXB32C19940	
	13	EXPANSION VALVE	1	ACXB05-01080	←	
	14	DISCHARGE MUFFLER (4 W. VALVE)	2	CWB121010	←	
	15	HOLDER COUPLING	1	CWH351233	←	
	16	2-WAYS VALVE (LIQUID)	1	ACXB02-03380	←	O
	17	3-WAY VALVE (GAS)	1	ACXB01-04540	←	O
⚠	19	REACTOR	1	G0C752J00004	←	O
	20	TERMINAL COVER	1	CWH171041	←	
	22	SOUND PROOF BOARD	1	CWH151427	←	
	23	SOUND PROOF MATERIAL	1	ACXG30-10200	←	
⚠	24	SENSOR CO - COMP TEMP	1	CWA50C2894	←	O
	25	CONTROL BOARD COVER - TOP	1	ACXH13-00450	←	
⚠	26	ELECTRONIC CONTROLLER - MAIN	1	ACXA73C61740R	ACXA73C61750R	O
⚠	27	TERMINAL BOARD ASSY	1	CWA28K1298	←	O
	28	CABINET SIDE PLATE CO.	1	ACXE04C05610	←	
⚠	29	SENSOR CO - AIR TEMP AND PIPE TEMP	1	CWA50C3079	←	O
	30	CABINET SIDE PLATE	1	ACXE04-00130A	←	
	31	CABINET FRONT PLATE CO.	1	CWE06C1563	←	
	32	CABINET TOP PLATE	1	CWE031230A	←	
	33	PLATE - C. B. COVER TERMINAL	1	CWH131301	←	
	34	CONTROL BOARD COVER CO.	1	CWH13C1359	←	
	38	4-WAYS VALVE	1	ACXB00-01290	←	O
⚠	39	V-COIL COMPLETE (4-WAY VALVE)	1	ACXA43C00250	←	O
	40	O-RING	1	ACXB81-06510	←	
	41	BAG - COMPLETE	1	CWG87C900	←	
⚠	42	V-COIL COMPLETE (EXP. VALVE)	1	ACXA43C06110	←	O
	43	STRAINER	1	CWB11094	←	
	44	DISCHARGE MUFFLER	1	CWB121021	←	
	46	PANASONIC BADGE	1	CWE373439	←	
	52	INSTALLATION INSTRUCTION	1	ACXF60-38420	←	
	53	INSTALLATION INSTRUCTION	1	ACXF60-38430	←	
	54	INSTALLATION INSTRUCTION	1	ACXF60-38440	←	
	55	INSTALLATION INSTRUCTION	1	ACXF60-38450	←	
	56	INSTALLATION INSTRUCTION	1	ACXF60-38460	←	

SAFETY	REF. NO.	PART NAME & DESCRIPTION	QTY.	CU-TZ20WKE	CU-TZ25WKE	REMARK
	57	INSTALLATION INSTRUCTION	1	ACXF60-38470	←	
	58	INSTALLATION INSTRUCTION	1	ACXF60-38480	←	
	59	INSTALLATION INSTRUCTION	1	ACXF60-38490	←	
	60	INSTALLATION INSTRUCTION	1	ACXF60-38500	←	
	61	INSTALLATION INSTRUCTION	1	ACXF60-38510	←	
	62	INSTALLATION INSTRUCTION	1	ACXF60-38520	←	
	63	BAG	1	CWG861078	←	
	64	BASE BOARD - COMPLETE	1	CWG62C1223	←	
	65	SHOCK ABSORBER (L)	1	CWG713779	←	
	66	SHOCK ABSORBER (R)	1	CWG713778	←	
	67	C. C. CASE	1	ACXG50-48861	←	
	68	MODEL LABEL	2	ACXF85-31590	ACXF85-31600	

(NOTE)

- All parts are supplied from PAPAMY, Malaysia (Vendor Code: 00029488).
- “O” marked parts are recommended to be kept in stock.

SAFETY	REF. NO.	PART NAME & DESCRIPTION	QTY.	CU-TZ35WKE	CU-TZ42WKE	REMARK
	1	CHASSIS COMPLETE	1	CWD52K1399	←	
	2	SOUND PROOF MATERIAL (TOP)	1	CWG302719	←	
	3	FAN MOTOR BRACKET	1	CWD541157	←	
	4	SCREW - FAN MOTOR BRACKET	2	CWH551217	←	
⚠	5	FAN MOTOR	1	L6CAYYYL0124	←	O
	6	SCREW - FAN MOTOR MOUNT	4	CWH55252J	←	
	7	PROPELLER FAN ASSY	1	CWH03K1100	←	
	8	NUT - PROPELLER FAN	1	CWH56053J	←	
⚠	9	COMPRESSOR	1	9RS102XMA21	9RS120XAA21	O
	10	ANTI - VIBRATION BUSHING	3	CWH50077	←	
	11	NUT - COMPRESSOR MOUNT	3	CWH561096	←	
	12	CONDENSER	1	ACXB32C15080	←	
	13	EXPANSION VALVE	1	ACXB05-01080	←	
	14	DISCHARGE MUFFLER (4 W. VALVE)	1	CWB121010	←	
	15	HOLDER COUPLING	1	CWH351233	←	
	16	2-WAYS VALVE (LIQUID)	1	ACXB02-03380	←	O
	17	3-WAY VALVE (GAS)	1	ACXB01-04540	ACXB01-02280	O
⚠	19	REACTOR	1	G0C752J00004	←	O
	20	TERMINAL COVER	1	CWH171039A	←	
	21	NUT - TERMINAL COVER	1	CWH7080300J	←	
	22	SOUND PROOF BOARD	1	CWH151427	←	
	23	SOUND PROOF MATERIAL	1	ACXG30-09370	←	
⚠	24	SENSOR CO - COMP TEMP	1	CWA50C2632	CWA50C2205	O
	25	CONTROL BOARD COVER - TOP	1	ACXH13-00450	←	
⚠	26	ELECTRONIC CONTROLLER - MAIN	1	ACXA73C61760R	ACXA73C61770R	O
⚠	27	TERMINAL BOARD ASSY	1	CWA28K1298	←	O
	28	CABINET SIDE PLATE CO.	1	ACXE04C00310	←	
⚠	29	SENSOR CO - AIR TEMP AND PIPE TEMP	1	CWA50C3079	←	O
	30	CABINET SIDE PLATE	1	ACXE04-00130A	←	
	31	CABINET FRONT PLATE CO.	1	CWE06C1566	←	
	32	CABINET TOP PLATE	1	CWE031230A	←	
	33	PLATE - C. B. COVER TERMINAL	1	CWH131301	←	
	34	CONTROL BOARD COVER CO.	1	CWH13C1359	←	
	36	SOUND PROOF MATERIAL	1	CWG302316	←	
	38	4-WAYS VALVE	1	ACXB00-01270	←	O
⚠	39	V-COIL COMPLETE (4-WAY VALVE)	1	ACXA43C06380	←	O
	40	O-RING	1	ACXB81-06510	←	
	41	BAG - COMPLETE	1	CWG87C900	←	
⚠	42	V-COIL COMPLETE (EXP. VALVE)	1	ACXA43C06110	←	O
	43	STRAINER	1	CWB11094	←	
	44	DISCHARGE MUFFLER	1	CWB121021	←	
	45	DISCHARGE MUFFLER	1	-	CWB121065	
	46	PANASONIC BADGE	1	CWE373439	←	
	52	INSTALLATION INSTRUCTION	1	ACXF60-38420	←	
	53	INSTALLATION INSTRUCTION	1	ACXF60-38430	←	
	54	INSTALLATION INSTRUCTION	1	ACXF60-38440	←	
	55	INSTALLATION INSTRUCTION	1	ACXF60-38450	←	
	56	INSTALLATION INSTRUCTION	1	ACXF60-38460	←	

SAFETY	REF. NO.	PART NAME & DESCRIPTION	QTY.	CU-TZ35WKE	CU-TZ42WKE	REMARK
	57	INSTALLATION INSTRUCTION	1	ACXF60-38470	←	
	58	INSTALLATION INSTRUCTION	1	ACXF60-38480	←	
	59	INSTALLATION INSTRUCTION	1	ACXF60-38490	←	
	60	INSTALLATION INSTRUCTION	1	ACXF60-38500	←	
	61	INSTALLATION INSTRUCTION	1	ACXF60-38510	←	
	62	INSTALLATION INSTRUCTION	1	ACXF60-38520	←	
	63	BAG	1	CWG861078	←	
	64	BASE BOARD - COMPLETE	1	CWG62C1223	←	
	65	SHOCK ABSORBER (L)	1	CWG713779	←	
	66	SHOCK ABSORBER (R)	1	CWG713778	←	
	67	C. C. CASE	1	ACXG50-48861	←	
	68	MODEL LABEL	2	ACXF85-31610	ACXF85-31620	

(NOTE)

- All parts are supplied from PAPAMY, Malaysia (Vendor Code: 00029488).
- “O” marked parts are recommended to be kept in stock.

SAFETY	REF. NO.	PART NAME & DESCRIPTION	QTY.	CU-RZ20WKE	CU-RZ25WKE	CU-RZ35WKE	REMARK
	1	CHASSIS COMPLETE	1	ACXD52K00150	←	CWD52K1399	
	2	SOUND PROOF MATERIAL (TOP)	1	CWG302737	←	CWG302719	
	3	FAN MOTOR BRACKET	1	CWD541157	←	←	
	4	SCREW - FAN MOTOR BRACKET	2	CWH551217	←	←	
⚠	5	FAN MOTOR	1	L6CAYYYL0124	←	←	O
	6	SCREW - FAN MOTOR MOUNT	4	CWH55252J	←	←	
	7	PROPELLER FAN ASSY	1	CWH03K1100	←	←	
	8	NUT - PROPELLER FAN	1	CWH56053J	←	←	
⚠	9	COMPRESSOR	1	9GS064XAA21	9GS075XAA21	9RS102XMA21	O
	10	ANTI - VIBRATION BUSHING	3	CWH501038	←	CWH50077	
	11	NUT - COMPRESSOR MOUNT	3	CWH561096	←	←	
	12	CONDENSER	1	ACXB32C14790	ACXB32C19940	ACXB32C15080	
	13	EXPANSION VALVE	1	ACXB05-01080	←	←	
	14	DISCHARGE MUFFLER (4 W. VALVE)	2, 1	CWB121010 (QTY: 2)	←	CWB121010 (QTY: 1)	
	15	HOLDER COUPLING	1	CWH351233	←	←	
	16	2-WAYS VALVE (LIQUID)	1	ACXB02-03380	←	←	O
	17	3-WAY VALVE (GAS)	1	ACXB01-04540	←	←	O
⚠	19	REACTOR	1	G0C752J00004	←	←	O
	20	TERMINAL COVER	1	CWH171041	←	CWH171039A	
	21	NUT - TERMINAL COVER	1	-	←	CWH7080300J	
	22	SOUND PROOF BOARD	1	CWH151427	←	←	
	23	SOUND PROOF MATERIAL	1	ACXG30-10200	←	ACXG30-09370	
⚠	24	SENSOR CO - COMP TEMP	1	CWA50C2830	←	CWA50C2205	O
	25	CONTROL BOARD COVER - TOP	1	ACXH13-00450	←	←	
⚠	26	ELECTRONIC CONTROLLER - MAIN	1	ACXA73C61780R	ACXA73C61790R	ACXA73C61800R	O
⚠	27	TERMINAL BOARD ASSY	1	CWA28K1298	←	←	O
	28	CABINET SIDE PLATE CO.	1	ACXE04C05610	←	ACXE04C00310	
⚠	29	SENSOR CO - AIR TEMP AND PIPE TEMP	1	CWA50C3079	←	←	O
	30	CABINET SIDE PLATE	1	ACXE04-00130A	←	←	
	31	CABINET FRONT PLATE CO.	1	CWE06C1563	←	CWE06C1566	
	32	CABINET TOP PLATE	1	CWE031230A	←	←	
	33	PLATE - C. B. COVER TERMINAL	1	CWH131301	←	←	
	34	CONTROL BOARD COVER CO.	1	CWH13C1359	←	←	
	36	SOUND PROOF MATERIAL	1	-	←	CWG302316	
	38	4-WAYS VALVE	1	ACXB00-01290	←	ACXB00-01270	O
⚠	39	V-COIL COMPLETE (4-WAY VALVE)	1	ACXA43C00250	←	ACXA43C06380	O
	40	O-RING	1	ACXB81-06510	←	←	
	41	BAG - COMPLETE	1	CWG87C900	←	←	
⚠	42	V-COIL COMPLETE (EXP. VALVE)	1	ACXA43C06110	←	←	O
	43	STRAINER	1	CWB11094	←	←	
	44	DISCHARGE MUFFLER	1	CWB121021	←	←	
	46	PANASONIC BADGE	1	CWE373439	←	←	
	52	INSTALLATION INSTRUCTION	1	ACXF60-38420	←	←	
	53	INSTALLATION INSTRUCTION	1	ACXF60-38430	←	←	
	54	INSTALLATION INSTRUCTION	1	ACXF60-38440	←	←	
	55	INSTALLATION INSTRUCTION	1	ACXF60-38450	←	←	
	56	INSTALLATION INSTRUCTION	1	ACXF60-38460	←	←	

SAFETY	REF. NO.	PART NAME & DESCRIPTION	QTY.	CU-RZ20WKE	CU-RZ25WKE	CU-RZ35WKE	REMARK
	57	INSTALLATION INSTRUCTION	1	ACXF60-38470	←	←	
	58	INSTALLATION INSTRUCTION	1	ACXF60-38480	←	←	
	59	INSTALLATION INSTRUCTION	1	ACXF60-38490	←	←	
	60	INSTALLATION INSTRUCTION	1	ACXF60-38500	←	←	
	61	INSTALLATION INSTRUCTION	1	ACXF60-38510	←	←	
	62	INSTALLATION INSTRUCTION	1	ACXF60-38520	←	←	
	63	BAG	1	CWG861078	←	←	
	64	BASE BOARD - COMPLETE	1	CWG62C1223	←	←	
	65	SHOCK ABSORBER (L)	1	CWG713779	←	←	
	66	SHOCK ABSORBER (R)	1	CWG713778	←	←	
	67	C. C. CASE	1	ACXG50-48861	←	←	
	68	MODEL LABEL	2	ACXF85-31660	ACXF85-31670	ACXF85-31680	

(NOTE)

- All parts are supplied from PAPAMY, Malaysia (Vendor Code: 00029488).
- "O" marked parts are recommended to be kept in stock.

## 22.2.2 CU-TZ50WKE CU-TZ60WKE CU-RZ50WKE

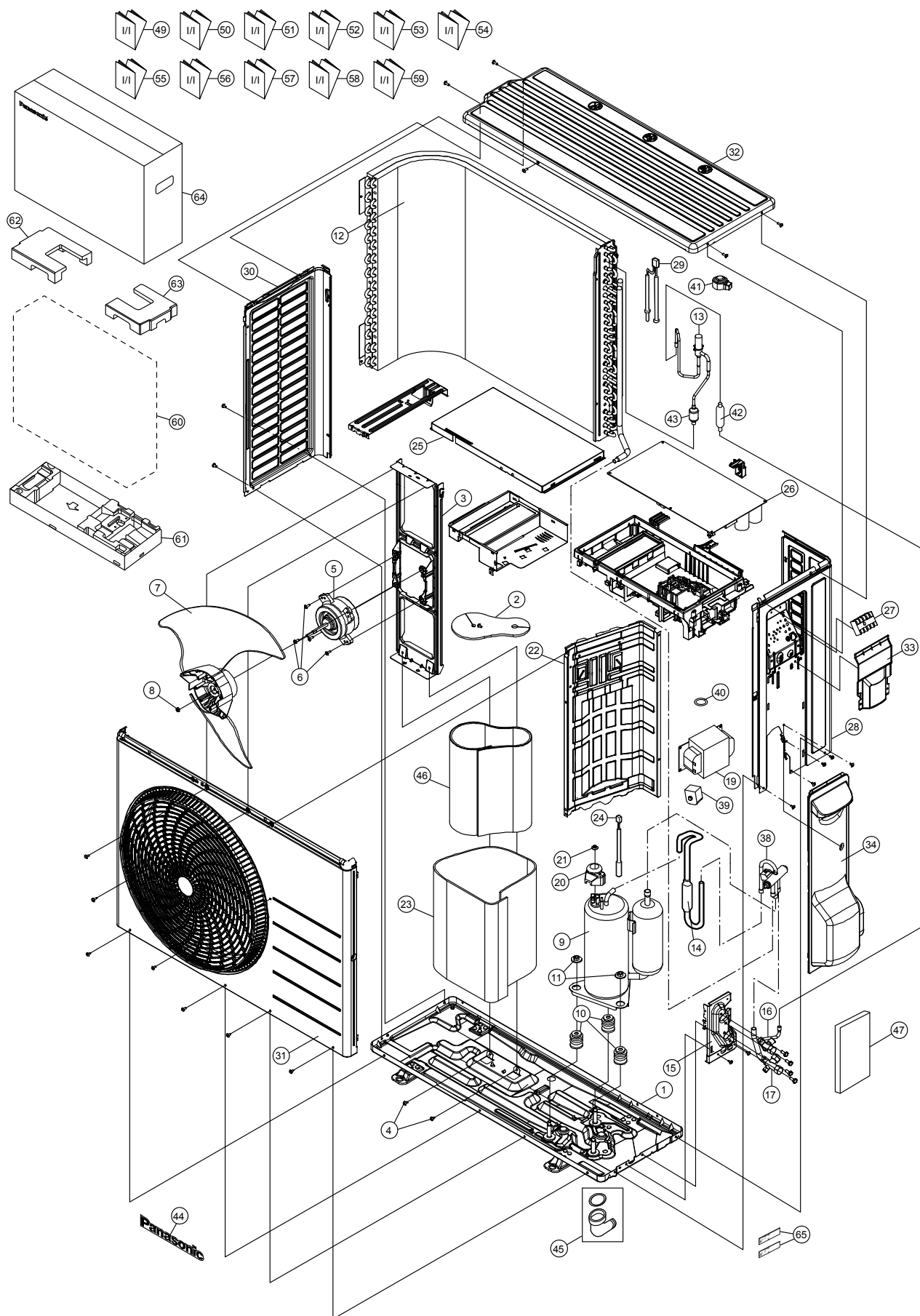

**Note**  
 The above exploded view is for the purpose of parts disassembly and replacement.  
 The non-numbered parts are not kept as standard service parts.

SAFETY	REF. NO.	PART NAME & DESCRIPTION	QTY.	CU-TZ50WKE	CU-TZ60WKE	CU-RZ50WKE	REMARK
	1	CHASSIS COMPLETE	1	CWD52K1277	←	←	
	2	SOUND PROOF MATERIAL	1	CWG302630	←	←	
	3	FAN MOTOR BRACKET	1	CWD541167	←	←	
	4	SCREW - FAN MOTOR BRACKET	2	CWH551217	←	←	
⚠	5	FAN MOTOR	1	L6CAYYYL0127	←	←	O
	6	SCREW - FAN MOTOR MOUNT	4	CWH55252J	←	←	
	7	PROPELLER FAN ASSY	1	CWH03K1066	←	←	
	8	NUT - PROPELLER FAN	1	CWH56053J	←	←	
⚠	9	COMPRESSOR	1	9RD132XAB21	←	←	O
	10	ANTI - VIBRATION BUSHING	3	CWH50077	←	←	
	11	NUT - COMPRESSOR MOUNT	3	CWH561096	←	←	
	12	CONDENSER	1	ACXB32C12500	←	←	
	13	EXPANSION VALVE	1	ACXB05-01080	←	←	
	14	DISCHARGE MUFFLER (4 W. VALVE)	1	CWB121010	←	←	
	15	HOLDER COUPLING	1	CWH351233	←	←	
	16	2-WAYS VALVE (LIQUID)	1	ACXB02-03280	←	←	O
	17	3-WAY VALVE (GAS)	1	ACXB01-04700	←	←	O
⚠	19	REACTOR	1	G0C392J00027	←	←	O
	20	TERMINAL COVER	1	CWH171039A	←	←	
	21	NUT - TERMINAL COVER	1	CWH7080300J	←	←	
	22	SOUND PROOF BOARD	1	CWH151273	←	←	
	23	SOUND PROOF MATERIAL	1	CWG302740	←	←	
⚠	24	SENSOR CO - COMP TEMP	1	CWA50C2894	←	CWA50C2830	O
	25	CONTROL BOARD COVER - TOP	1	CWH131473	←	←	
⚠	26	ELECTRONIC CONTROLLER - MAIN	1	ACXA73C61320R	ACXA73C61330R	ACXA73C61320R	O
⚠	27	TERMINAL BOARD ASSY	1	CWA28K1298	←	←	O
	28	CABINET SIDE PLATE CO.	1	ACXE04C05240	←	←	
⚠	29	SENSOR CO - AIR TEMP AND PIPE TEMP	1	CWA50C2893	←	CWA50C2825	O
	30	CABINET SIDE PLATE	1	ACXE04-10020	←	←	
	31	CABINET FRONT PLATE CO.	1	ACXE06C02910	←	←	
	32	CABINET TOP PLATE	1	ACXE03-02880	←	←	
	33	PLATE - C. B. COVER TERMINAL	1	CWH131470	←	←	
	34	CONTROL BOARD COVER CO.	1	CWH13C1253	←	←	
	38	4-WAYS VALVE	1	ACXB00-01290	←	←	O
⚠	39	V-COIL COMPLETE (4-WAY VALVE)	1	ACXA43C00250	←	←	O
	40	O-RING	1	ACXB81-06510	←	←	
⚠	41	V-COIL COMPLETE (EXP. VALVE)	1	ACXA43C06110	←	←	O
	42	DISCHARGE MUFFLER	1	CWB121058	←	←	
	43	STRAINER	1	CWB11094	←	←	
	44	PANASONIC BADGE	1	CWE373439	←	←	
	45	BAG - COMPLETE	1	CWG87C900	←	←	
	46	SOUND PROOF MATERIAL	1	CWG302952	←	←	
	47	SOUND PROOF MATERIAL	1	CWG302745	←	←	
	49	INSTALLATION INSTRUCTION	1	ACXF60-38420	←	←	
	50	INSTALLATION INSTRUCTION	1	ACXF60-38430	←	←	
	51	INSTALLATION INSTRUCTION	1	ACXF60-38440	←	←	
	52	INSTALLATION INSTRUCTION	1	ACXF60-38450	←	←	

SAFETY	REF. NO.	PART NAME & DESCRIPTION	QTY.	CU-TZ50WKE	CU-TZ60WKE	CU-RZ50WKE	REMARK
	53	INSTALLATION INSTRUCTION	1	ACXF60-38460	←	←	
	54	INSTALLATION INSTRUCTION	1	ACXF60-38470	←	←	
	55	INSTALLATION INSTRUCTION	1	ACXF60-38480	←	←	
	56	INSTALLATION INSTRUCTION	1	ACXF60-38490	←	←	
	57	INSTALLATION INSTRUCTION	1	ACXF60-38500	←	←	
	58	INSTALLATION INSTRUCTION	1	ACXF60-38510	←	←	
	59	INSTALLATION INSTRUCTION	1	ACXF60-38520	←	←	
	60	BAG	1	ACXG86-03760	←	←	
	61	BASE BOARD COMP.	1	CWG62C1144	←	←	
	62	SHOCK ABSORBER (L)	1	CWG713416	←	←	
	63	SHOCK ABSORBER (R)	1	CWG713415	←	←	
	64	C. C. CASE	1	ACXG50-48870	←	←	
	65	MODEL LABEL	2	ACXF85-31630	ACXF85-31640	ACXF85-31690	

(NOTE)

- All parts are supplied from PAPAMY, Malaysia (Vendor Code: 00029488).
- “O” marked parts are recommended to be kept in stock.

## 22.2.3 CU-TZ71WKE

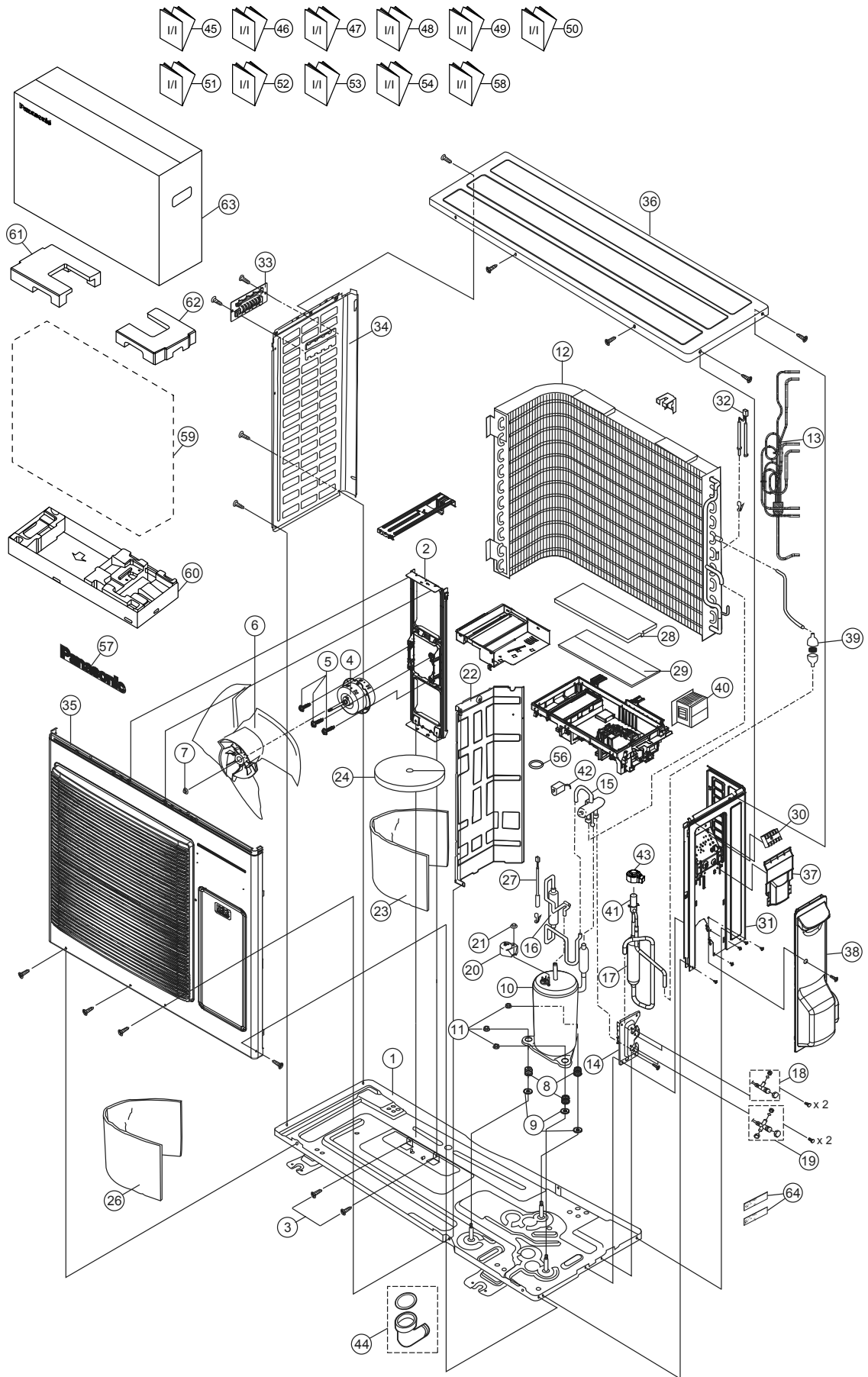

**Note**  
 The above exploded view is for the purpose of parts disassembly and replacement.  
 The non-numbered parts are not kept as standard service parts.

SAFETY	REF. NO.	PART NAME & DESCRIPTION	QTY.	CU-TZ71WKE	REMARK
	1	CHASSIS COMPLETE	1	ACXD52K00280	
	2	FAN MOTOR BRACKET	1	ACXD54-00140	
	3	SCREW - FAN MOTOR BRACKET	2	CWH551217	
⚠	4	FAN MOTOR	1	L6CAYYYL0076	O
	5	SCREW - FAN MOTOR MOUNT	4	CWH551106J	
	6	PROPELLER FAN ASSY	1	ACXH03K00070	
	7	NUT - PROPELLER FAN	1	CWH56053J	
	8	ANTI - VIBRATION BUSHING	3	CWH50055	
	9	PACKING	3	CWB81043	
⚠	10	COMPRESSOR	1	9KD240XBA21	O
	11	NUT - COMPRESSOR MOUNT	3	CWH561049	
	12	CONDENSER	1	ACXB32C01930	
	13	TUBE ASSY (CAPILLARY TUBE)	1	ACXT00C05240	
	14	HOLDER COUPLING	1	ACXH35-00080	
	15	4-WAYS VALVE	1	ACXB00-00140	O
	16	DISCHARGE MUFFLER	1	CWB121013	
	17	RECEIVER	1	CWB14030	
	18	2-WAYS VALVE (LIQUID)	1	ACXB02-03220	O
	19	3-WAY VALVE (GAS)	1	CWB011363	O
	20	TERMINAL COVER	1	CWH171039A	
	21	NUT - TERMINAL COVER	1	CWH7080300J	
	22	SOUND PROOF BOARD	1	ACXH15-00230	
	23	SOUND PROOF MATERIAL	1	CWG302997	
	24	SOUND PROOF MATERIAL	1	CWG302246	
	26	SOUND PROOF MATERIAL	1	CWG302636	
⚠	27	SENSOR CO - COMP TEMP	1	CWA50C2185	O
	28	CONTROL BOARD COVER - TOP	1	ACXH13-00490	
⚠	29	ELECTRONIC CONTROLLER - MAIN	1	ACXA73C61960R	O
⚠	30	TERMINAL BOARD ASSY	1	CWA28K1298	O
	31	CABINET SIDE PLATE CO.	1	ACXE04C03340	
⚠	32	SENSOR CO - AIR TEMP AND PIPE TEMP	1	CWA50C3079	O
	33	HANDLE	1	CWE161010	
	34	CABINET SIDE PLATE	1	ACXE04-00670	
	35	CABINET FRONT PLATE ASSY	1	ACXE06K00080	
	36	CABINET TOP PLATE	1	ACXE03-00200	
	37	PLATE - C. B. COVER TERMINAL	1	CWH131470	
	38	CONTROL BOARD COVER CO.	1	ACXH13C00170	
	39	STRAINER	1	CWB111032	
⚠	40	REACTOR	1	G0C392J00040	O
	41	EXPANSION VALVE	1	ACXB05-01070	
⚠	42	V-COIL COMPLETE (4-WAY VALVE)	1	ACXA43C00250	O
⚠	43	V-COIL COMPLETE (EXP. VALVE)	1	ACXA43C06110	O
	44	BAG - COMPLETE	1	CWG87C900	
	45	INSTALLATION INSTRUCTION	1	ACXF60-38420	
	46	INSTALLATION INSTRUCTION	1	ACXF60-38430	
	47	INSTALLATION INSTRUCTION	1	ACXF60-38440	
	48	INSTALLATION INSTRUCTION	1	ACXF60-38450	
	49	INSTALLATION INSTRUCTION	1	ACXF60-38460	
	50	INSTALLATION INSTRUCTION	1	ACXF60-38470	

SAFETY	REF. NO.	PART NAME & DESCRIPTION	QTY.	CU-TZ71WKE	REMARK
	51	INSTALLATION INSTRUCTION	1	ACXF60-38480	
	52	INSTALLATION INSTRUCTION	1	ACXF60-38490	
	53	INSTALLATION INSTRUCTION	1	ACXF60-38500	
	54	INSTALLATION INSTRUCTION	1	ACXF60-38510	
	56	O-RING	1	ACXB81-06510	
	57	PANASONIC BADGE	1	CWE373439	
	58	INSTALLATION INSTRUCTION	1	ACXF60-38520	
	59	BAG	1	CWG861461	
	60	BASE BOARD COMPLETE	1	ACXG62C00230	
	61	SHOCK ABSORBER (L)	1	CWG713217	
	62	SHOCK ABSORBER (R)	1	CWG713218	
	63	C. C. CASE	1	ACXG50-48881	
	64	MODEL LABEL	2	ACXF85-31650	

(NOTE)

- All parts are supplied from PAPAMY, Malaysia (Vendor Code: 00029488).
- "O" marked parts are recommended to be kept in stock.